



***Optimal
seating posture
for everyone!***



Sedeo® more than just good cushions!

For over 25 years movingpeople.net has successfully developed, produced and distributed unique mobility products.

The innovative, adjustable Sedeo® seating system is an example of our comprehensive seating and positioning range. The Sedeo® system is used on a broad range of manual and powerchairs.

movingpeople.net has a program of continuous product improvement and is introducing this new generation of Sedeo® cushions and seating options. The primary design criteria were comfort, versatility and modern look.

Sedeo® : more than just good cushions

Sitting posture requires more than choosing the right cushions. Careful adjustment to obtain the right sitting and backrest angles is also important. The Sedeo® seat system provides you with the optimal sitting posture. Sedeo® consists of an individually adjustable frame onto which a variety of seating and positioning components can easily be fitted.

The combination of modular construction and width adjustments provide a unique customized seating system for each individual.



People will enjoy and use their mobility product more when they have the proper body position. The Sedeo® seat system supports the entire body, providing the user with optimum comfort.

Benefits:

- *Adjustable*
- *Optimum comfort for the client*
- *Numerous options*
- *Unparalleled versatility*
- *Upholstered with comfortable Sellaskin®*
- *Modular construction*
- *Available for all movingpeople.net manual and active chairs*

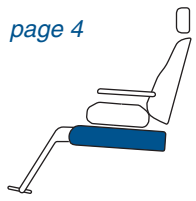
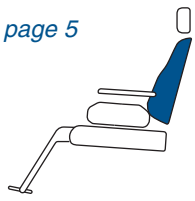
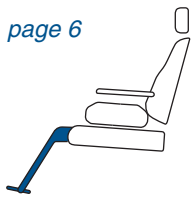
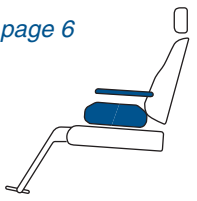

Various options...

		SEATS	BACKRESTS	LEG SUPPORT	ARMRESTS SIDE CUSHIONS	HEAD RESTS
SEATING SOLUTION	BASIC	<i>page 4</i> 	<i>page 5</i> 	<i>page 6</i> 	<i>page 6</i> 	<i>page 7</i> 
		Standard seat Seat with webbing Memory foam seat Support seat Balance seat	Standard backrest Backrest with lumbar support Extra soft backrest Backrest with webbing Support backrest Backrest with straps	Central legrest Standard legrests Comfort legrests	Various dimensions Wedge-shaped side cushions	Type 4, small model Type 2, large model Type 3, flexible model
	SPECIALS	Pan seat Arthrodesis seat Abduction support	Back pad Shoulder rest	Amputation support	Angle adjustable armrest Hemiplegia	

SEATWIDTH (A)	SUITABLE FOR HIP MEASUREMENTS (B)
15" (Robin only)	13.5" to 15.5"
16.5"	15" to 17"
18"	16.5" to 18.5"
19.5"	18" to 20"

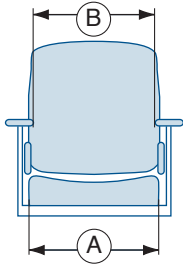

MOUNTING

A. The backrest can be mounted at two different heights.

B. Various seat depths can be achieved using just one seat cushion by mounting the cushion in different positions.

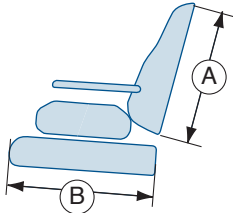

Upholstery

All Sedeo® components are available in black Sellaskin®.

Sellaskin® is a soft and comfortable material.

Other seats are upholstered in black stretch rubber for extra comfort.

Backrests in black stretch fabric also provide extra comfort.

The seats and backrests can also be provided in fabric.

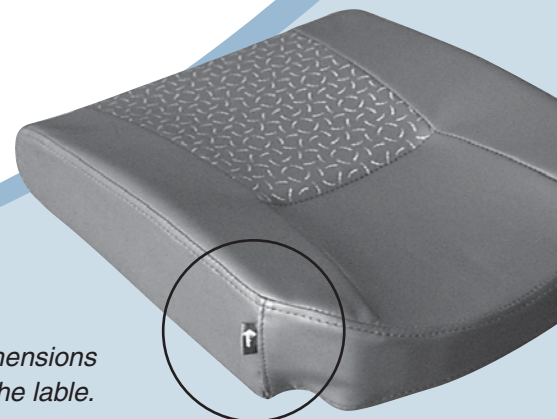

The cushions' dimensions are indicated on the label.

Look for the original Sedeo®-label!

Seats

Width sizes 16.5 – 18 – 19.5 inch

Depth sizes 17.5 – 19 inch

1 Standard seat

- Profiled
- Sellaskin® upholstery

2 Seat with webbing

- Profiled
- Improved sitting position due to webbing
- Stretch rubber upholstery
- Filled with extra soft polyethelene

3 Memory foam seat

- Profiled
- Filled with memory foam
- Good pressure distribution
- Stretch rubber upholstery

4 Support seat

- Contoured
- Design prevents slumping
- Provides pressure distribution
- Filled with various types of extra soft polyethelene
- Stretch rubber upholstery

5 Balance seat

- The special internal construction supports the thigh bone condyles to minimize pressure on the tailbone condyles (coccyx)
- Excellent pressure distribution
- High lateral stability
- Design prevents slumping
- Stretch rubber upholstery

6 Pan seat

- Depth-adjustable rear threshold
- Universal solution for various anti-decubitus cushions
- Adjustment range 15 – 18 inch
- Sellaskin® upholstery

7 Arthrodesis seat

- Suitable for people with stiff or deformed hip joints
- Sellaskin® upholstery

This seat must be used in a separate frame. It is advisable to combine this seat with comfortable legrests to support the leg at the right angle and prevent the client from slumping in the chair.

SELLASKIN®
UPHOLSTERY



1

EXCELLENT
COMFORT

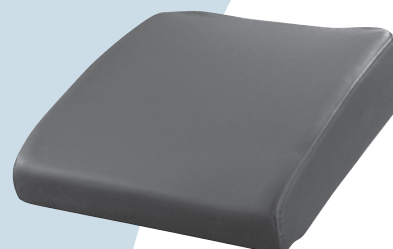

2

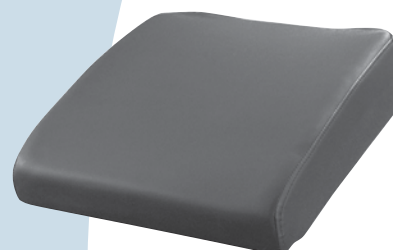

3

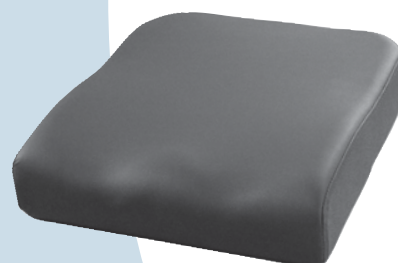

4

EXCELLENT
PRESSURE DISTRIBUTION

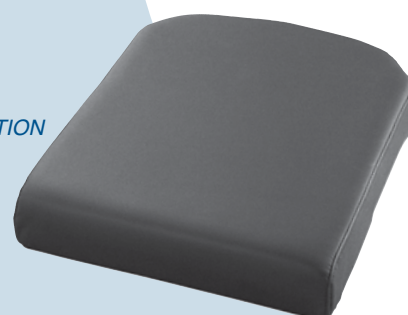

5

UNIVERSAL

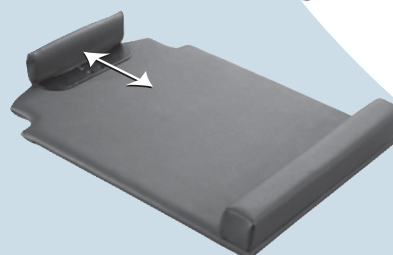

6

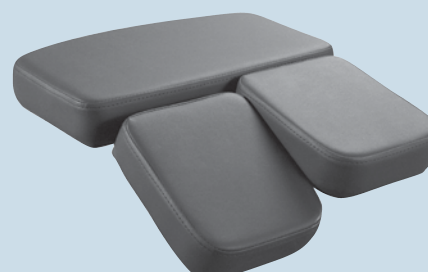

7

Backrests

Width sizes 16.5 – 18 – 19.5 inch

Height sizes 20.5 – 22.5 inch

1 Standard backrest

- Profiled
- Sellaskin® upholstery



1

2 Backrest with lumbar support

- Inflatable lumbar support
- Profiled
- Sellaskin® upholstery



2

3 Extra soft backrest

- Extra soft polyethelene for added comfort
- Stretch fabric upholstery



3

4 Backrest with webbing

- Profiled
- Webbing promotes better posture
- Good pressure distribution
- Stretch fabric upholstery
- Filled with extra soft polyethelene
- Ideal for people with kyphotic posture



4

STRETCH FABRIC
UPHOLSTERY

5 Support backrest

- Extra profiled
- Extra lateral support
- Sellaskin® upholstery



5

6 Backrest with straps

- Adjustable straps which follow the contours of the back
- Stretch fabric upholstery
- Extra soft polyethelene
- Extra soft polyethelene
- The ideal backrest for many support solutions



6

INDIVIDUAL
ADJUSTABLE

EXTRA
SUPPORT

7 Shoulder rest

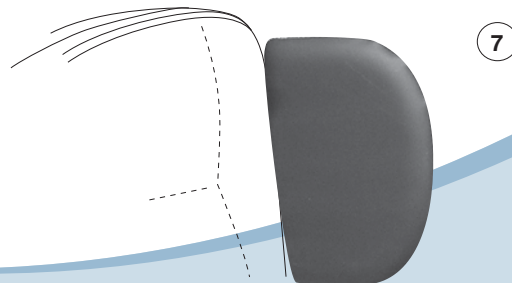

7

8 Thoracic pad

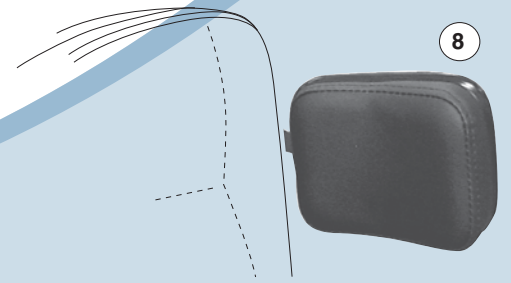

8

Leg support

1 Central legrest

- Adjustable lower leg length
- Continuously adjustable knee angle
- Trapezoid calf plate
- Also available in shortened versions
- Optional adjustable ankle angle available

1a Option: calf plate with side support



1

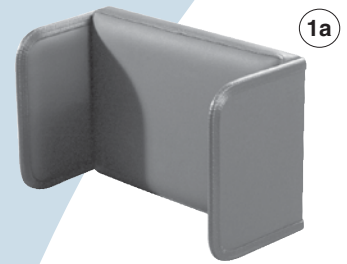

1a

2 Standard legrests

- Length adjustable
- Swing-away
- Fitted with angle adjustable footplates

2a Option: calfplates



2

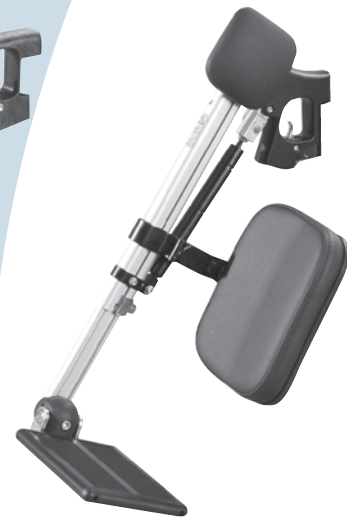

3

3 Comfort legrests

- Length adjustable
- Swing-away
- Fitted with angle adjustable footplates
- Length compensation is ensured by optimum positioning of the pivot point
- Also available in power version

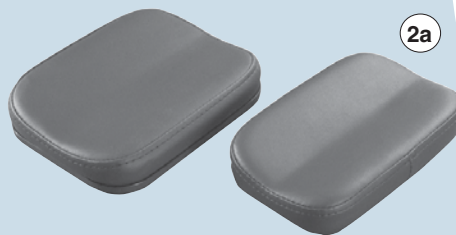

2a



4

4 Amputation support

- Angular adjustment

Armrests

5 Armrests

- Various dimensions
- P-shaped armrests are used on the 24" Ibis

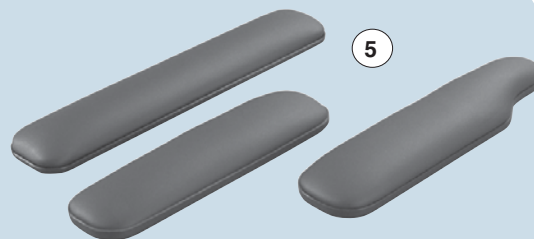

5

6 Angle adjustable armrest

- Can be combined with a worktop with adjustable angle



6



7

7 Hemiplegia armrest

- Can be mounted on the left or the right
- Adjustable depth and height
- The cup-shaped support rotates

Side cushions

1 Side cushions

- Standard side cushion
- Wedge-shaped and extra long side cushion

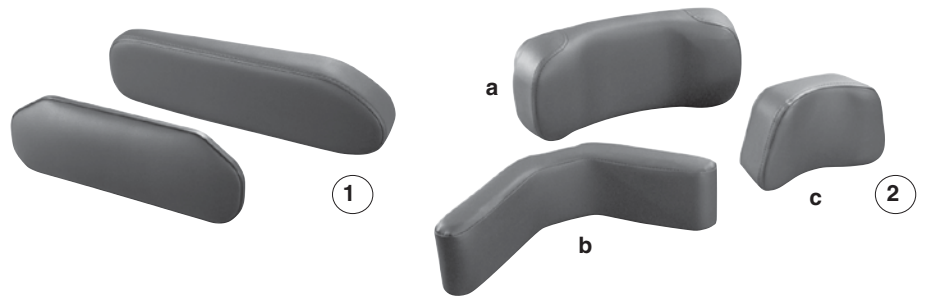

Head rests

2a Head rest type 2, large model

2b Head rest type 3, flexible model

2c Head rest type 4, small model

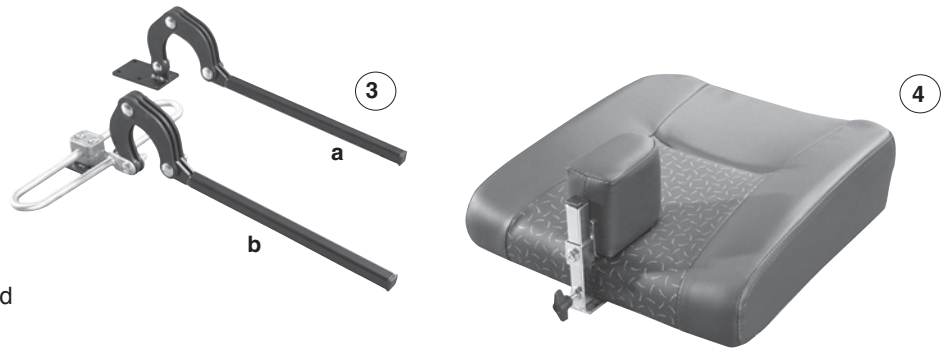

3a The height and depth of the standard metal section are adjustable

3b Metal section with adjustable width

Abduction support⁴

Worktops

- With abdominal recess
- With or without padding
- Fixed (with 2 insert tubes) or folding



IBISX-Series



PUMA

BEATLE

IBIS



Y·e·S Series



movingpeople.net wheelchair selections and configuration will vary by country. Contact your local representative for details.

movingpeople.net Nederland b.v. T +31 (0)492 59 38 88
F +31 (0)492 53 79 31
movingpeople.net UK Ltd. T +44 (0)1932 85 86 87
F +44 (0)1932 84 83 84

www.movingpeople.net

The community for you!