

English

Date	Order	User name	Address
------	-------	-----------	---------

Seat

- Seat cloth with pocket (under seat)
- Seat with tension straps 08883 **£ 196**
- Carbon rigid seat 08336 **£ 415**
- Pocket (under seat) [25x11x4,5] 08281 **£ 65**

Backrest with rake adjustable from -4° to +16°

- Light adjustable velcro straps and padded transpiring upholstery SPORT
- Backrest with double locking (upright and folded)
- Backrest with upright locking system ONLY (no locking when folded)
- Fixed back (non-folding back)
 - Aluminium backrest
 - Titanium backrest
 - Carbon fibre backrest (Lightest configuration)



06811	£ 109
04389	£ 600

A I R - Integrated posture backrest (not removable) - Lateral retaining 6,5cm. 06815 **£ 1015**
 not available for seat width 48 - Std. Backrest upholstery not provided - Handle tube aluminium with short tubes

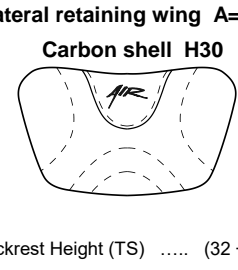
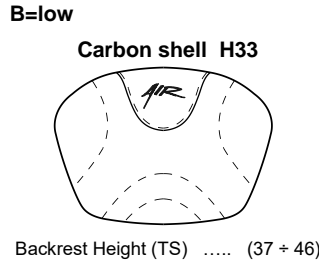
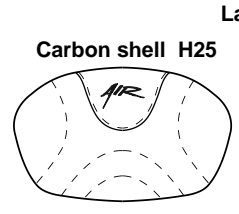

Backrest Height (TS) min 29 max 41

AIR Cover

- Cover Standard - fabric insert: GREY, stitchings GREY
- Cover SPORT** 09195 **£ 87**
 - fabric insert: BLACK - Stitchings GREY
 - fabric insert: BLACK - Stitchings LIME
 - fabric insert: BLACK - Stitchings ORANGE
 - fabric insert: BLACK - Stitchings RED
 - fabric insert: BLACK - Stitchings BLUE
 - fabric insert: BLACK - Stitchings BLACK
 - fabric insert: BLACK - Stitchings FUCHSIA
 - fabric insert: BLACK - Stitchings ANTHRACITE
- Cover ACTIVE** 09195 **£ 87**
 - fabric insert: RED - Stitchings BLACK
 - fabric insert: LIME - Stitchings BLACK
 - fabric insert: BLUE - Stitchings BLACK

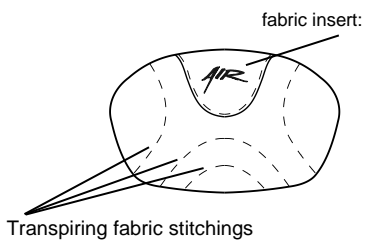

Handle tube

- Handle tube with short tubes
- Handle tube SPORT Without push handles
- Carbon fibre handle (with short tubes) (Lightest configuration) 04390 **£ 109**

Not available with: Posture backrest PHYSIO - Posture backrest A I R

- Folding handles aluminium 02958 **£ 218**

Colour set: Rear wheels and forks - To be matched only with: Rear wheels Ultra-light Progeo - Standard! (22 - 24)

- Black 22" 24" 25" 26" 00833 **£ 109**
- Bright silver 22" 24" 00833 **£ 109**
- Bright fuchsia 22" 24" 00833 **£ 109**
- Bright blue 22" 24" 00833 **£ 109**
- Bright red 22" 24" 00833 **£ 109**
- Bright lime 22" 24" 00833 **£ 109**
- Pearl white 24" 00833 **£ 109**

Casters

- 4" Soft
- 3" Sport (Lightest configuration)
- 5" Soft Not available with frame angle 90° to the floor
- 3" Active Soft (wide) (Aluminium alloy rim) 06824 **£ 109**
- 4" Active Sport (narrow) (Aluminium alloy rim) 01398 **£ 109**
- 4" Active Soft (wide) (Aluminium alloy rim) 03943 **£ 109**
- 5" Active Soft (wide) (Aluminium alloy rim) 07518 **£ 109**

Rehateam s.r.l. Vicolo Negrelli, 4 - 31040 Castagnole di Paese (TV) - Tel. +39.0422.484657 / +39.0422.480387 - Fax +39.0422.484661 / +39.0422.484684
 P.IVA IT 03182520266 - C.C.I.A.A. TV n.41690 Capitale Sociale I.V. Euro.100.000,00

Email: info@rehateamprogeo.com - web: http://www.rehateamprogeo.com

English

Date	Order	User name	Address
------------	-------------	-----------------	---------------

Rear wheels

- ☆ 24" Ultra-light Progeo - Standard!
- 22" Ultra-light Progeo - Standard!
- 25" Ultra-light Progeo - Standard!
- 26" Progeo - Standard!
- 24" ULTRA-LIGHT PROGEO KEY SPORT (Lightest configuration) 04383 £ 742
- 24" Ultra-light "Spinergy LX" 01685 £ 742
- 24" Ultra-light "Spinergy Flex rim" 02270 £ 1200
- 24" Ultra-light "Spinergy LX" Black hub and white blade spokes Hub and blade spokes black 07846 £ 742
- 25" Ultra-light "Spinergy LX" 02101 £ 742
- 25" Ultra-light "Spinergy LXL" Black hub and white blade spokes 07847 £ 742
- 26" Ultra-light "Spinergy LX" 02102 £ 742
- 24" Off-road (aluminium handrim black) 01392 £ 164

Rear wheel tyre

- ☆ High pressure tyre (22"-24"-25"-26") (Lightest configuration)
- High pressure profile tyre (24")
- Marathon Plus (24"-25") with anti-puncture protection 01669 £ 55
- Solid tyre Kik Mako - Colour Black (24") 01041 £ 87
- Solid tyre Kik Mako - Colour Grey (24") 01751 £ 87

Handrim - Wheel distance

- | | | | | |
|--|--------|--|-------|-------|
| | ★ 3 cm | <input type="checkbox"/> 4 cm | | |
| ☆ Aluminium (22"-24"-25"-26") (Lightest configuration) | | | | |
| <input type="radio"/> Aluminium black SOFT-TOUCH (24"-25") | | | 09170 | £ 109 |
| <input type="radio"/> Chromed Steel (24"-25") | | | 01684 | £ 109 |
| <input type="radio"/> Titanium (24"-25") | | | 00016 | £ 218 |
| <input type="radio"/> Ultra Grepp (24"-25") | | | 00017 | £ 262 |
| <input type="radio"/> Max Grepp (24"-25") | | | 00834 | £ 305 |
| <input type="radio"/> Ergo Para (24") | | | 00632 | £ 305 |
| <input type="radio"/> SURGE LT (24"-25") | | Oval countour with a rubber insert | 06427 | £ 316 |
| <input type="radio"/> Quad (24") (24") | | | 00693 | £ 175 |
| <input type="radio"/> Silicon cover for standard aluminium handrim | | Available for measures (22"-24"-25"-26") | 04050 | £ 142 |

Wheel locks

- ☆ Bent lever push to lock
- Straight lever Push to lock
- Straight lever Pull to lock
- Sport brake OUT-FRONT (Lightest configuration) 06428 £ 109
- Brake with extension lever push to lock 01949 £ 55
- Brake with extension lever pull to lock 03372 £ 55

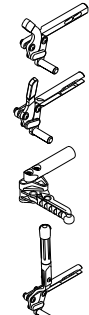

Mudguard

- ☆ Carbon fibre mudguard
- Carbon fibre Straight sideguard

★ Aligned wheel	<input type="checkbox"/> Under wheel cm	<input type="checkbox"/> Above wheel cm		
-----------------	---	---	--	--
- Removable carbon fibre mudguard 04109 £ 218
- Removable Carbon fibre straight sideguard

★ Aligned wheel	<input type="checkbox"/> Under wheel cm	<input type="checkbox"/> Above wheel cm	04109	£ 218
-----------------	---	---	-------	-------
- Welded straight mudguard

Available only with made-to-measure welded frame and fixed and welded backrest				
★ Aligned wheel	<input type="checkbox"/> Under wheel cm	<input type="checkbox"/> Above wheel cm	08933	£ 327

Armrests

- Swing away armrests (Swing away, removable and height adjustable armrest) 00694 £ 218
- ☆ Pad STANDARD
- Ergonomic pad (30x6 cm.) 04104 £ 55

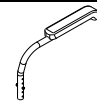

Optional 1

- Set-up for post-sale optional assembly
- Transit wheels 03290 £ 131
- Crutches support

<input type="radio"/> Right	00838	£ 65
<input type="radio"/> Left	00837	£ 65
- Anti-tipper with rapid hookup (inside rotation to reduce the encumbrance)

<input type="radio"/> Right	06821	£ 109
<input type="radio"/> Left	06822	£ 109
- Tipping aid

<input type="radio"/> Right	00025	£ 55
<input type="radio"/> Left	01046	£ 55





Rehateam s.r.l. Vicolo Negrelli, 4 - 31040 Castagnede di Paese (TV) - Tel. +39.0422.484657 / +39.0422.480387 - Fax +39.0422.484661 / +39.0422.484684
 P.IVA IT 03182520266 - C.C.I.A.A. TV n.225867 - Iser.Trib. TV n.41690 Capitale Sociale I.V. Euro.100.000,00

Email: info@rehateamprogeo.com - web: http://www.rehateamprogeo.com

English

Date	Order	User name	Address
------	-------	-----------	---------

Optional 2



- Push handles for companion **(Removable and height adjustable)**  03645 £ 153
- Pad for front frame protectors 07058 £ 39
- Tetraclip **(Quick release axle for quadriplegic)** 03947 £ 131
- Safety pelvic belt 03972 £ 55
- Harness 04103 £ 109
- Lumbar support **(to insert in the backrest upholstery)** 00013 £ 33
- Swing away lateral support Right 02097 £ 218
 Not available with: Left 02098 £ 218

- Posture backrest **PHYSIO - Posture backrest A I R**
- Spoke guards Black (22"-24") 01043 £ 131
- Spoke guards Transparent (22"-24") 00835 £ 131
- Spoke guards Progeo design (22"-24") 00019 £ 153
- Spoke guards Dragon (22"-24") 02106 £ 153

Additional Kit

- 24" Off-road rear wheels **(only with aluminium handrim)** 03378 £ 436

PHYSIO - Posture backrest

Std. Backrest upholstery not provided

- Aluminum shell - Lateral retaining STANDARD 7,5cm  Height 25 33 41 05308 £ 884
Height 52 05309 £ 938
Lateral retaining wing A=high B=low
- Aluminum shell - Lateral retaining DEEP 15cm  Height 25 33 41 05310 £ 938
H25 not available for seat width 39-42-45-48
Height 52 05311 £ 993
Lateral retaining wing A=high B=low
- Carbon shell - Lateral retaining STANDARD 7,5cm  Height 25 33 41 05312 £ 1015
Lateral retaining wing A=high B=low

COVER

☆ Cover with fabric-cover of backrest's rear side and high refraction fabric hems



- SWING AWAY - Lateral support
Not available with Physio backrest with lateral retaining DEEP and in carbon backrest

Internal thoracic support to the backrest width, adjustable (0 ÷ -1,5cm)

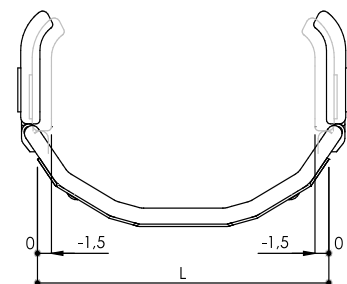

- Large (17,5x11,5)
- Left 05646 Right 05647
- Small (14x9,5)
- Left 05642 Right 05643
- Additional Kit for internal thoracic support to the backrest width, adjustable (-8,5 ÷ -10cm)

Internal thoracic support to the backrest width, adjustable (-4 ÷ -5,5cm)

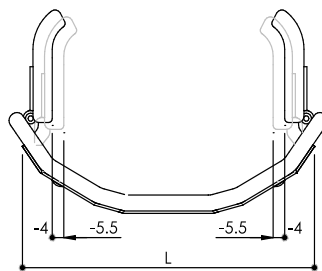

- Large (17,5x11,5)
- Left 05646 Right 05647
- Small (14x9,5)
- Left 05642 Right 05643

Internal thoracic support to the backrest width, adjustable (-8,5 ÷ -10cm)

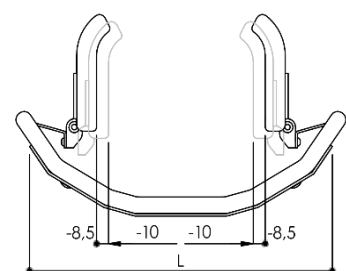

- Large (17,5x11,5)
- Left 05646 Right 05647 £ 175
- Small (14x9,5)
- Left 05642 Right 05643 £ 175
- (with additional kit) Right 05643 £ 175

- Headrest adjustable - Double ball mounting system
Not available for Physio backrest's height 25 and with carbon shell

- Large (34x14) 05648 £ 393
- Small (28x14)



Rehateam s.r.l. - Vicolo Negrelli, 4 - 31040 Castagnole di Paese (TV) - Tel. +39.0422.480387 - Fax +39.0422.484661 / +39.0422.484684
 P.IVA IT 03182520266 - C.C.I.A.A. TV n.41690 Capitale Sociale l.v. Euro 100.000,00

Email: info@rehateamprogeo.com - web: http://www.rehateamprogeo.com

Date

Order

English
User name

Address

Rehateam s.r.l. Vicolo Negrelli, 4 - 31040 Castagnole di Paese (TV) - Tel. +39.0422.484657 / +39.0422.480387 - Fax +39.0422.484661 / +39.0422.484684
P.IVA IT 03182520266 - C.C.I.A.A. TV n.225867 - Iscr.Trib. TV n.41690 Capitale Sociale I.V. Euro 100.000,00

1	A Footplate width			
	DP	35÷39	40÷45	46÷50
LS				
33	21	20	19	
36	24	23	22	
39	26	25	24	
42	29	28	27	
45	32	31	30	
48	35	34	33	

2	Setting	C :
	Extremely prudential	7,5
	Prudential	9
	Standard	10,5
	Active	12
	Extreme	13,5

3	Lt
Camber	Maximum width
0°	LS + 18
2°	LS + 21
4°	LS + 24
8°	LS + 30
12°	LS + 36

Maximum width calculated including 3 cm. distance between tyre and handrim

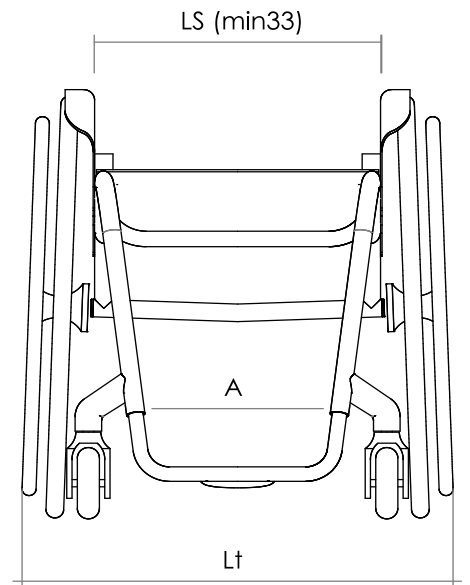
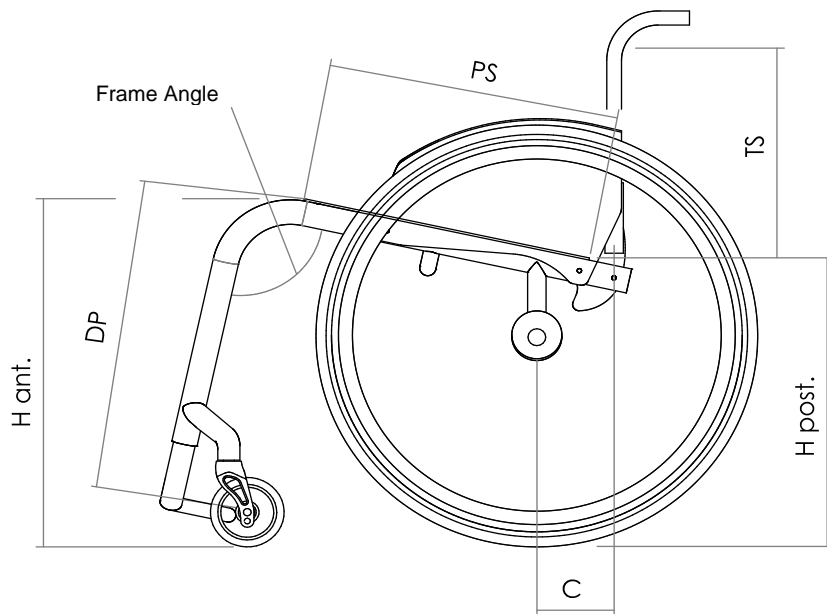

Italia Certified company normative UNI EN ISO 9001

Important notice! is page only if any optional have been chosen