



SERVICE MANUAL

ENGLISH



SERVICE MANUAL

JOKER R2

Rev. 0 - 06/05/2020



progeo
ACTIVE DESIGN



JOKER R2

GENERAL WARNINGS

ANY ADJUSTMENT CAN BE CARRIED OUT EXCLUSIVELY BY QUALIFIED AND AUTHORIZED BY REHATEAM® PERSONNEL.

It is forbidden to carry out any modifications, even when possible, to the original design.

Any adjustments and/or any modification that is carried out by non-authorized personnel will immediately void the warranty on the product and it relieves RehaTEAM® from any responsibility on any malfunctioning and/or damage due to such adjustments/modifications.

Always contact RehaTEAM® and its technicians for any non-standard requirements or modifications to allow them to evaluate such modifications and verify that they will not compromise the normal and safe use of the wheelchair.

Any modification of the original parameters and set up could seriously compromise the safe operation of the wheelchair causing damage to both the user and the wheelchair itself.

After every adjustment made to the wheelchair, check carefully that all parts are correctly fixed. Check that all screws and nuts are tightened and that all moving parts are functioning correctly.

After any adjustment, always test the wheelchair before giving the product to user and/or his/her attendant.

RehaTEAM® disclaims any responsibility for damage to the product or the people due to any modification that is not properly performed or that, in any case, does not guarantee safety to the user.



SERVICE MANUAL

JOKER R2

Page	adjustment
04	FRONT HEIGHT Caster on fork
05	FORK ANGLE Fork support V-Design
06	DIRECTIONALITY
08	REAR HEIGHT Standard rear unit
09	REAR HEIGHT Full Carbon side plates
10	SETTING (point of balance) Standard rear unit
11	SETTING (point of balance) Full Carbon side plates
12	CAMBER AND CONVERGENCY
14	BRAKE
15	BRAKE SPACING
16	SIDE GUARD Standard rear unit
18	REMOVABLE SIDE GUARD Standard rear unit
20	FOOTPLATE DISTANCE tubes with holes
21	FOOTPLATE DISTANCE sliding system (until 2018)
22	TUBULAR ALUMINIUM FOOTPLATE
23	ALUMINIUM FOOTPLATE WITH CURVED TUBES
24	ALUMINIUM FLIP-BACK FOOTPLATE
25	CARBON FIBRE FOOTPLATE
26	“U” TUBE ALUMINIUM FOOTPLATE
27	BACKREST HEIGHT Aluminium or titanium backrest
28	BACKREST HEIGHT Carbon fibre backrest
29	BACKREST ANGLE
30	SEAT WIDTH ENLARGEMENT
31	QUICK RELEASE AXLE (rear wheel)



SERVICE MANUAL

FRONT HEIGHT

caster on fork



Sport – 2 holes – h. 88

Piccola – 3 holes – h. 112



The entity of the adjustment obviously depends on the caster and fork's sizes.

Screw off the bolt **V** while holding the other.

Remove the axle **P**.

Position the caster to another hole, insert the axle and fix the bolt **V** holding the one on the other side.

Pay attention to the spacers between caster and fork.



It is advisable to spread a drop of mild lock thread glue on the bolts **V**.



FORK ANGLE

SERVICE MANUAL

WORK ON A FLAT AND EVEN SURFACE

Whenever the seat height is changed or as periodic maintenance, check the fork angle and, if necessary, adjust it in order to have the fork axis perpendicular to the ground.

The adjustment is possible by means of the four grab screws **G1**, **G2** and **G3** that make the axle **P** turn on the fulcrum **F**.

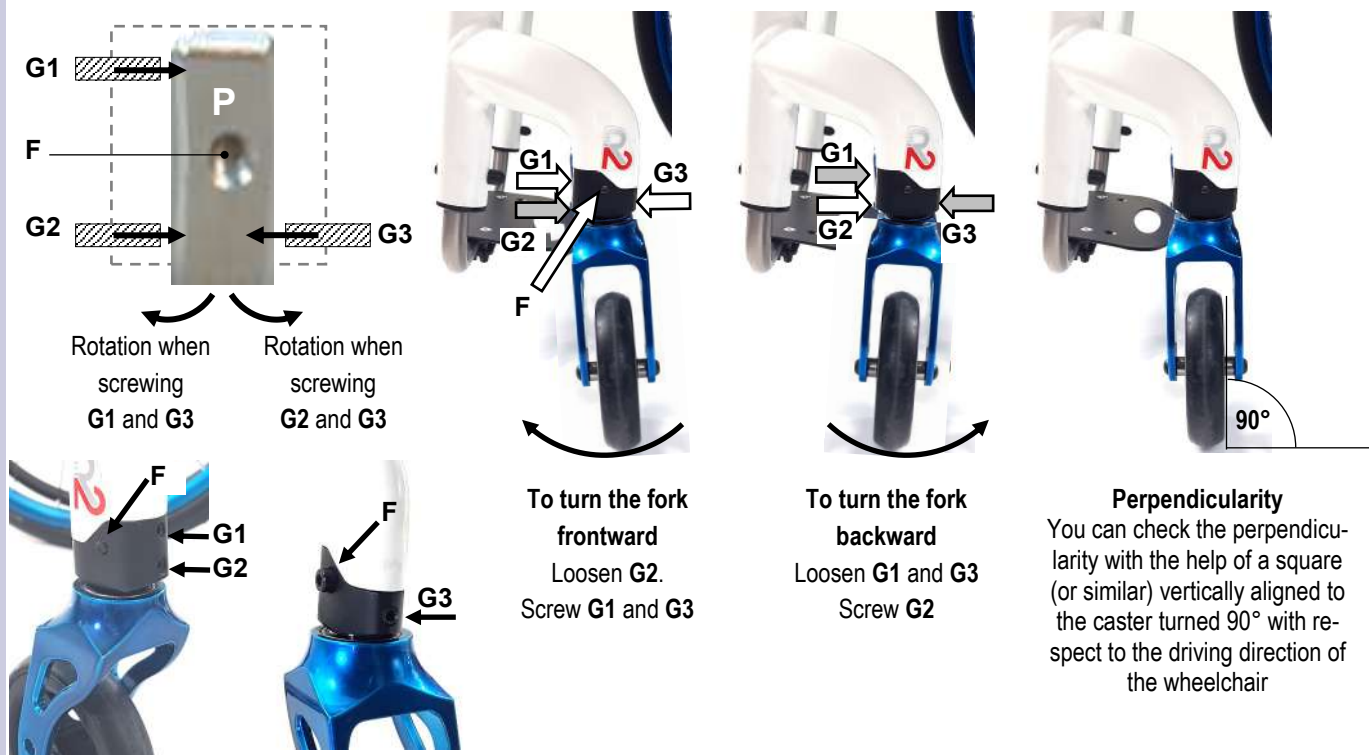

To adjust the fork, once you know the direction (forward or backward) towards which it is necessary to move the fork's axle, proceed as above-mentioned until reaching the correct angle.

You can also measure the perpendicularity by turning the fork by 360°: during the full turn, the wheel has to touch the surface in all positions.



If a headless bolt results hard to unscrew, DO NOT FORCE IT, but try to loosen the other two first.

If the fork's axle (the axle **P**) results hard to move, slightly loosen the bolt of the fulcrum **F** (remember to screw it after adjustment).

Once you reach the correct angle, screw all three headless bolts all the way down to the axle **P**, but without tightening.

In order to fix the system, tighten first one and then the other less than a quarter of a turn at once, the grab screws **G1** and **G2** (the front ones) checking the perpendicularity; in fact, it may slightly change during this phase.

Should that happen, correct the angle proceeding in the same manner.

When you have tightened both headless bolts **G1** and **G2**, you can tighten the headless bolt **G3**.

Check the perpendicularity again and, if necessary, correct it.



It is advisable to pread a drop of mild lock thread glue on all grab screws **G**.



DIRECTIONALITY

SERVICE MANUAL

A very important aspect of any wheelchair is its directionality.

To check if the wheelchair goes straight, sit on it, push it and let it go until it stops.

If something is wrong, the slower the wheelchairs moves forward (momentum close to nothing), the more likely it turns right or left. Therefore, if no or irrelevant turn occurs, the wheelchair is properly adjusted.

Cause	Reason	Solution
SURFACE	The surface where the test is being performed is not even and flat	Test the chair on even and flat surface
REAR WHEELS	The rear wheel are not equally inflated	Inflate both tyres at the same pressure
	The tyres of the two rear wheel are different or differently	Change the tyres
	The rear wheels are not adjusted at the same height	Adjust the rear wheel height
	The camber of right and left wheels are different or differently adjusted	Adjust the camber.
	The wheel, when turning, touches the side guard or the brakes	Fix or replace the side guard. Add spacer on the receiver. Adjust the brake.
	The wheels do not turn smoothly	Clean or change the bearings
FRONT WHEELS	The casters are not adjusted at the same height	Adjust the front wheels at the same height
	The tyres of the two front wheels are different or differently	Change the wheels
	The fixing bolts of the fork/fork support/clamp are loosened	Check and tighten all fixing bolts
	The caster does not turn smoothly	Clean the bearings.
	Either or both forks are not adjusted so as their axis is perpendicular to the ground.	Adjust the fork axis inclination.
FOOTPLATE	The footplate tubes are adjusted at different height.	Adjust the tubes at the same height

If the wheelchairs does not go straight, in most cases the reason is the fork angle adjustment.

However, before working on the fork angle adjustment, check all the points above mentioned.

First, make the test along a flat even surface to check the directionality.

1 The correct adjustment has both forks perpendicular to the ground, that is, their axis at 90°.

2 If the wheelchair **TURN RIGHT**, the cause is one or more of the following:

The **RIGHT** fork is tilted **inwardly** and/or **backward**
The **LEFT** fork is tilted **outwardly** and/or **frontward**

3 If the wheelchair **TURN LEFTT**, the cause is one or more of the following:

The **LEFT** fork is tilted **inwardly** and/or **backward**
The **RIGHT** fork is tilted **outwardly** and/or **frontward**

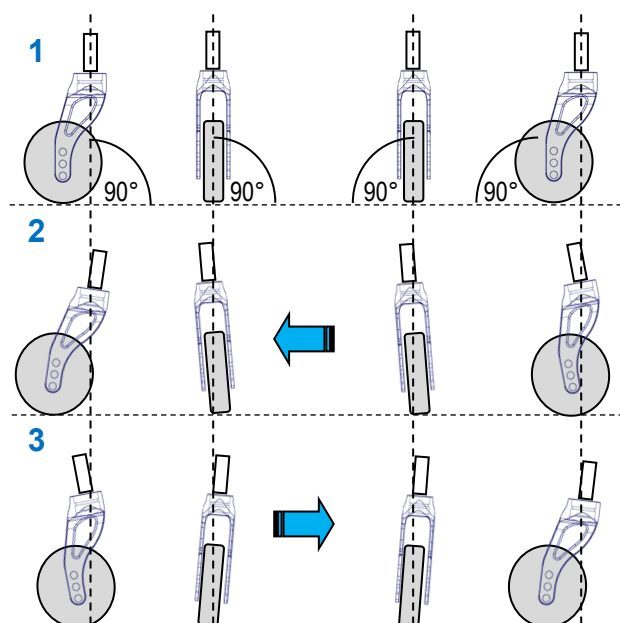

Follows next page



DIRECTIONALITY

SERVICE MANUAL

ADJUSTING THE DIRECTIONALITY

Check that the two forks are perpendicular to the ground. If they are not, proceed with the adjustment of the fork angle following the instructions on the sheet FORK ANGLE ADJUSTMENT.

If both forks axis are correct but the wheelchair still turns right or left, it means that the latitudinal angle is not perfect.

This may be due to hit, to improper pressure exercised on the fork or its support, or to a tiny imperfection among all parts fixed together due to their manufacturing tolerances.

You can fix the fork axle **P** in three different angles to correct the directionality.

Loosen all four grab screws **G**, remove the bolt **F** and slide off the fork complete with the axle **P**.

The axle has two side hollows **B** where you have to cast the flat inserts **C0** or the 1° tilted inserts **C1** that are recognizable thanks to two dots.

With the flat inserts **C0**, the axle keep its original inclination.

With the tilted inserts **C1**, the axle tilts by 1° right or left according to how to cast them in the hollows—see images.

Note: you can cast the inserts only as indicated in these images.

Once you have casted the inserts **C0** or **C2**, it is advisable to try to screw the bolt **F** to check there is no difficulty. Sometimes, in fact, the holes of the inserts may have working burr that make the bolt hard to go through.

To mount the fork unit. Insert the axle **P** in the fork support paying attention to the orientation of the same axle. In fact, the axle is not straight, but it shows a bend. Such bend must be facing to the rear of the wheelchair.

Insert and screw the bolt **F** without tightening it much (it is enough to screw it up to stop).

Adjust the fork angle — see sheet “fork angle”.

Note. This type of adjustment can take place even at original assembly, therefore, you may find the inserts **C0** on one axle and **C1** on the other, for instance.

The wheelchair is not supplied with supplementary inserts, therefore, it will be necessary to order them when needed.

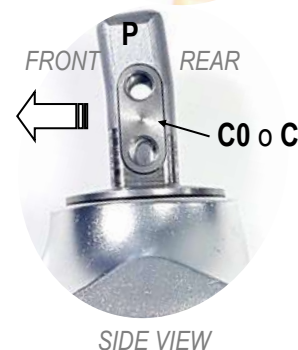
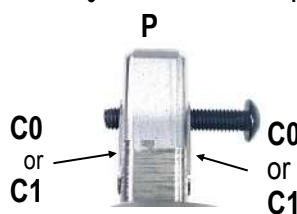
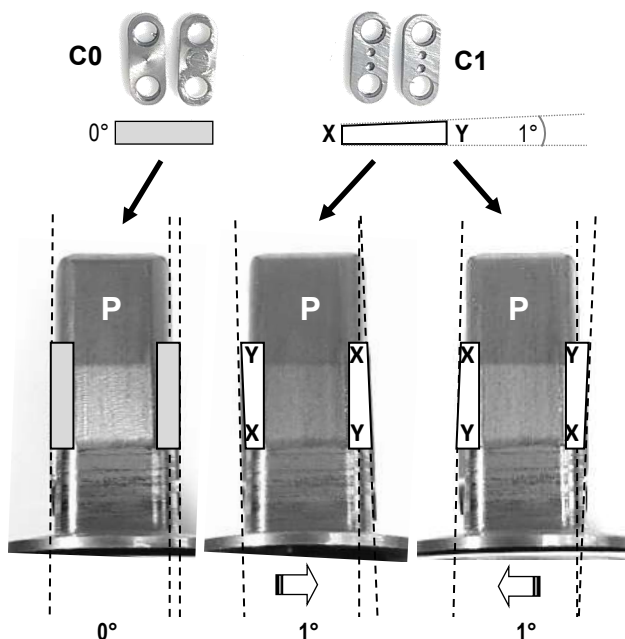
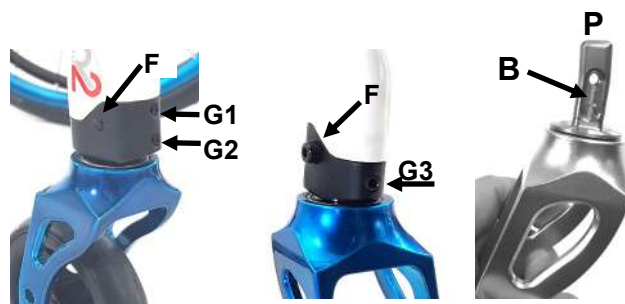

Axles without inserts

Until 2019 the axles had no inserts **C0** or **C1**. There were 0°, 1°rh and 1°lh axles. To adjust the directionality, it is necessary to change the axle.



SERVICE MANUAL

REAR HEIGHT

STANDARD REAR UNIT

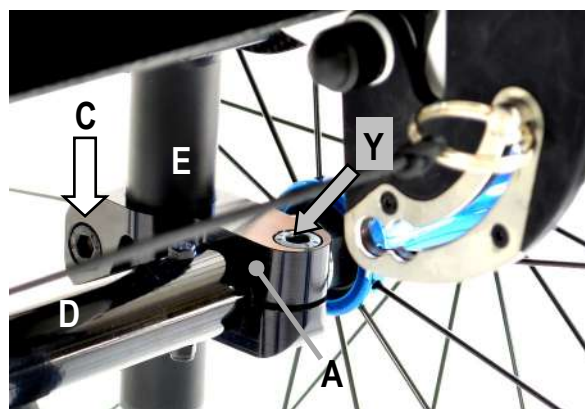

When decreasing the rear height it is necessary to remove the mudguard first, in fact, the tyre will touch it and it will impede the adjustment. With fixed mudguards, you need to remove bolts **V1** and **V2**. With removable mudguard, just pull it off. If the side guard is straight, leave it where it is.

Loosen the grab screw **B** on the rear lower side of both clamps **A**.

Loosen the bolt **C** of both clamps **A**.

Now you can slide the two clamps **A** along the posts **E**.

Should the clamps be hard to slide, loosen the bolts **B** and **C** and/or, with care, hit them with a mallet to the necessary direction. Such operation may result particularly useful for the final adjustment when the necessary movement is very little.

The rear axle **D** always remains fixed to the clamps **A**.

The grab screw **X** and the bolt **Y** are not involved in this adjustment.

Slide the system to the necessary height.

Fix the clamp **A** of either side, tightening the bolt **C** hard and then tighten the grab screw **B**.

Before fixing the other side, check the height is the same.

To make sure that right and left side are at the same height, take measure from two "fix points", for instance: straight line from the hole of the post where side-guard fixing bolt **V2** is fixed (with removable side guard, this hole is free) to the upper side of the clamp **A**, or from the clamp **A** to the middle of inner plate **F** of the clamp that holds the frame.

When changing the rear height it is necessary to modify the mudguard. However, if the side-guard is straight you may leave it as it is, its upper edge will be lower or higher with respect to the tyre.

To remove and adapt the side guards, follow instruction of sheet "side guard adjustment".

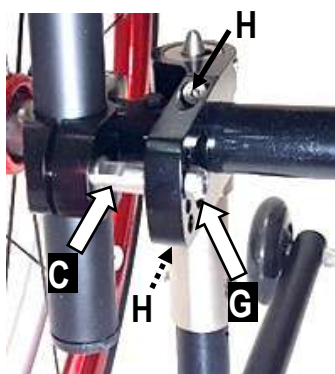
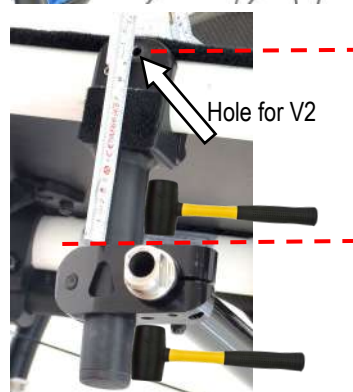
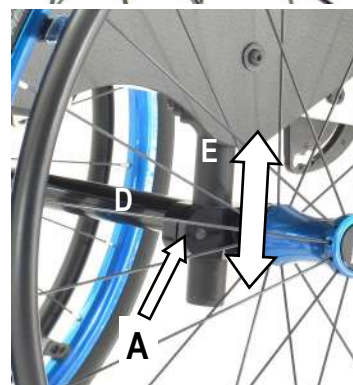

In presence of anti-tipper support, the bolt **C** is different; in fact, it is involved in the support's assembly. To proceed with the height adjustment, remove the nut **G**, loosen the two bolts **H** and move the support away from the bolt **C**.

Now you can loosen the bolt **C** and continue the adjustment as above explained.

To re-assemble the support, slide it in along the bolt **C** choosing the one of the 4 holes and check which one give you the best inclination of the anti-tipper. Then fix it with the nut **G** and finally tighten the two bolts **H**.

Remember that the rear height adjustment can affect the seat inclination, thus, it is necessary to check and adjust the fork angle.



It is advisable to spread a drop of mild lock thread glue on the grab screws **B**.



SERVICE MANUAL

REAR HEIGHT

FULL CARBON SIDE PLATES

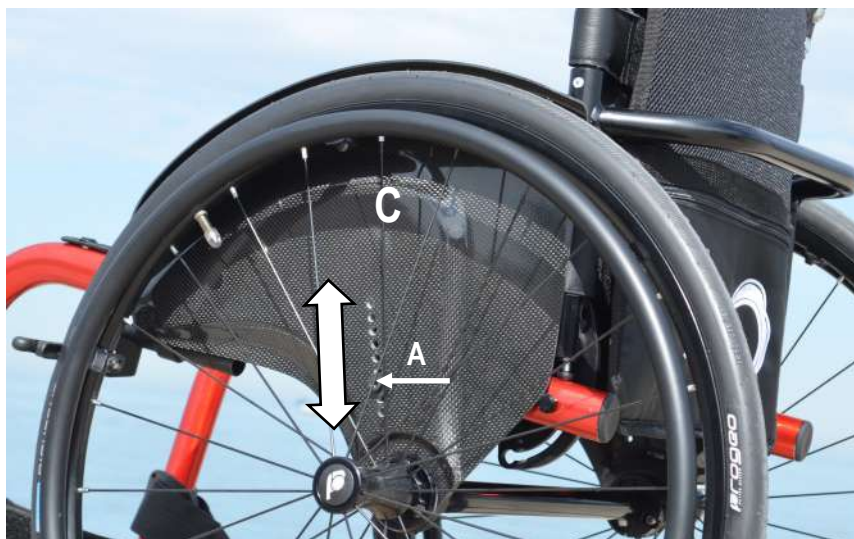

Adjustment every 1 cm.

Remove the bolt **A** on both sides of the wheelchair. The inner plate of the clamp-support **B** and the nut will come off.

Move the frame up or down until aligning the hole of the support **B** (not visible in the picture because it lays between the plate and the frame, but it is indicated by the dotted rectangle) with one of those of the plate **C**.

Then insert the bolt **A**, the inner plate and the nut in its location.

When tightening this bolt, check that the inner plate of the clamp does not turn (you can hold it with your fingers), in fact, if it turns, the clamp will not take hold of the frame properly.

Finally tighten the bolt.

There is no need to use a spanner to hold the nut; in fact, its location on the inner clamp will hold it.

Check/adjust the brakes.

Remember that the rear height adjustment can affect the seat inclination, so it is necessary to check and adjust the fork angle.

The rear height adjustment can also change the point of balance (setting) of the wheelchair.

If necessary, adjust the setting.

You will never need to modify the side guard.

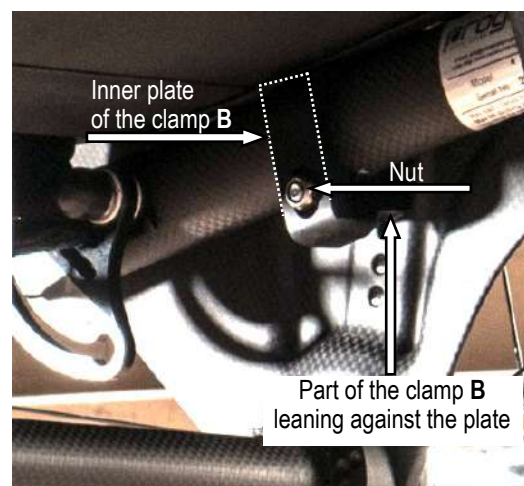
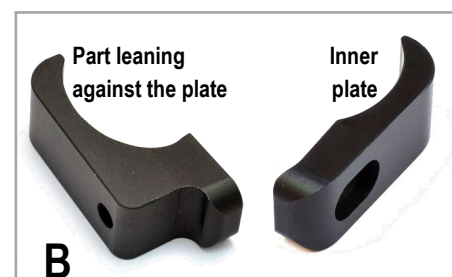
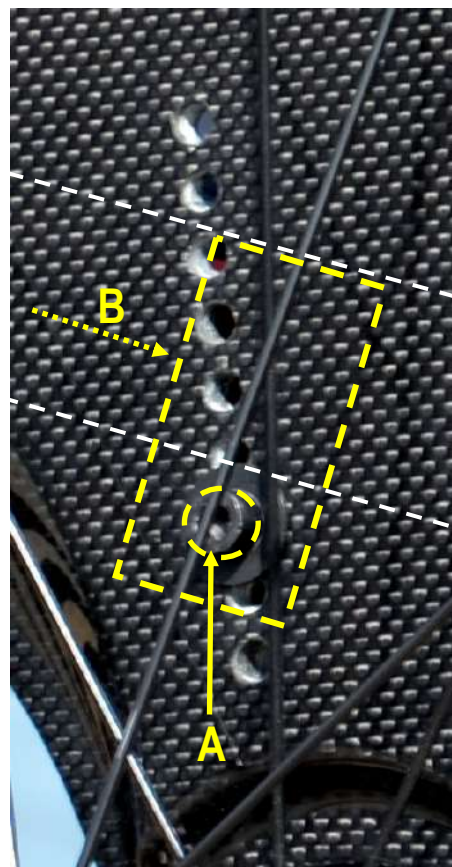



SERVICE MANUAL

SETTING (point of balance)

STANDARD REAR UNIT

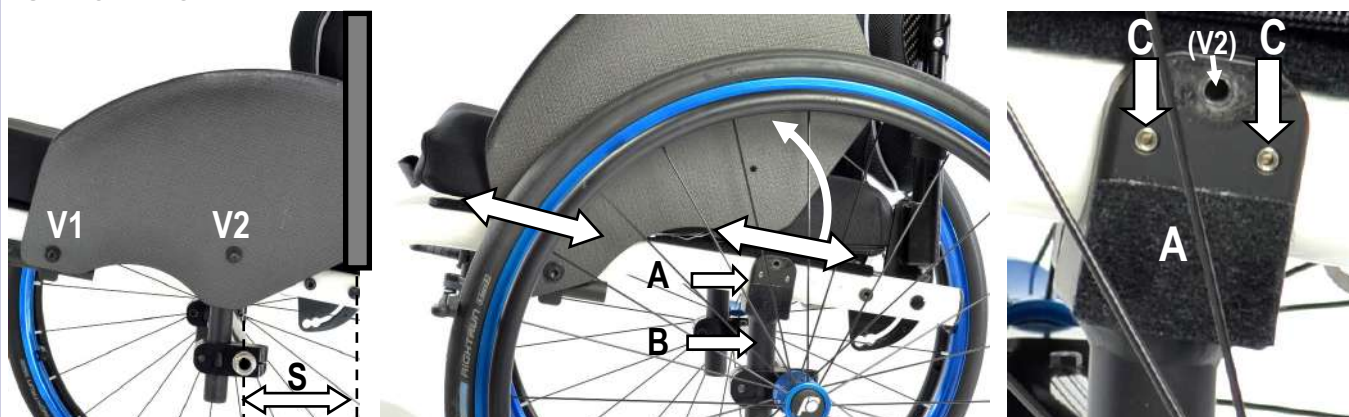

Thanks to a sliding system, you can adjust the setting of the wheelchair every millimetre.

Remove the bolt/washer **V2** and swing the side guard up until you can get access to the clamp **A** of the post **B**.

Loosen the two grab screws **C** of the clamp **A**.

Loosen the bolt **D** and the two nuts **E** that you find on the inner side of the clamp **A**.

Repeat the same operation on both sides of the wheelchair.

Loosen the bolt **V1** that fixes the front clamp **F** that is also the brake support, of both sides of the wheelchair. Note: the bolt is screwed into a threaded rivet fixed to the front axle, or, if the front axle is not present, that bolt is screwed into a nut.

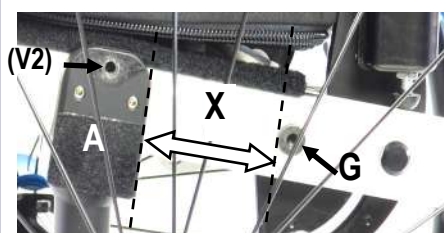
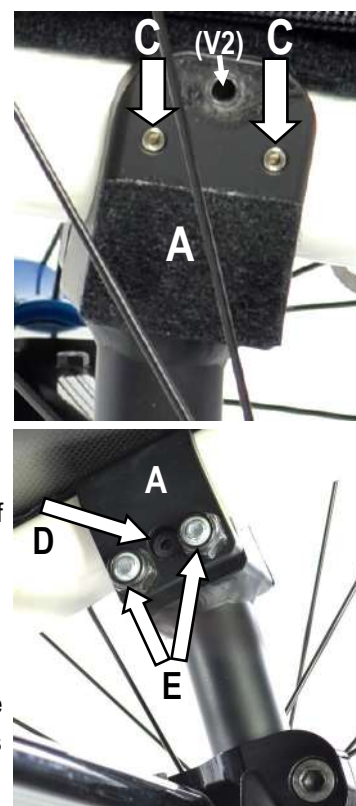

Slide the clamps **A** forward or backward along the frame. If the tyre touches the brake, move the front clamps forward. It may be possible to scratch the frame, so it is advisable to proceed with care without forcing the system.

Once you reach the necessary setting, tighten the two nuts **E** first, then the bolt **D** and finally the grab screws **C** of one clamp **A**.

Before fixing the other side, make sure the two clamps are at the same distance.

A good reference point is the distance **X**, from the rear side of the clamp **A** to the bolt **G** that fixes the backrest plate.

Now, swing the side guard down and slide it along the frame (the front clamps are still loosened) until aligning the hole with the threaded one of the clamp and fix it with the bolt/washer **V2**. **WARNING:** fit the bolt **V2** with care to prevent damaging the thread of the threaded hole. Repeat the same operation on the other side and finally fix the bolt **V1** of both sides.

The fixed side guard does not need any modification; on the other hand, the removable side guard will have to be adjusted (see sheet "side guard adjustment"). You do not need to adjust the brakes.

The predetermined settings that appear in the order form have the following distance **S** (from the backrest's axis to the wheel's axis): Prudential 9.0 cm; Standard 10.5 cm; Active 12.0 cm; Extreme 13.5 cm.

Following the instruction above, you can reach a particularly prudential setting approx. 5 cm (distance **X** = 0, rear clamp in contact with the backrest plate).



It is advisable to spread a drop of mild lock thread glue on the grab screws **B**.

Remember that the setting adjustment can affect the seat inclination, so it is necessary to check and adjust the fork angle.

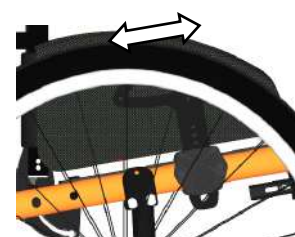



SERVICE MANUAL

SETTING (point of balance)

FULL CARBON SIDE PLATES



Remove the rear wheel.

Loosen the bolt **A** of the front clamp **B** and put the wheel back on.

Note: the bolt is screwed into a threaded rivet fixed to the front axle, or, if the front axle is not present, that bolt is screwed into a nut.

Repeat the same operation on both sides of the wheelchair.

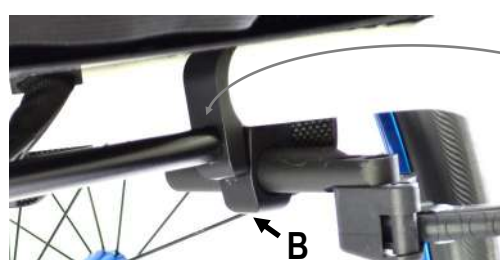
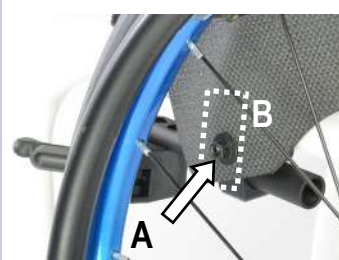
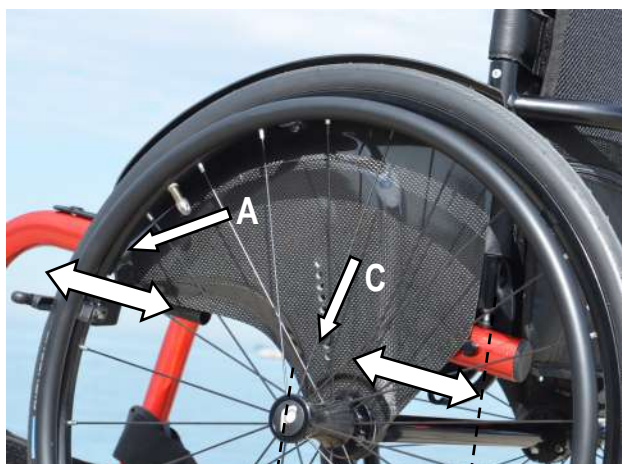

Loosen the bolt **C** of the rear clamp **D** on both plates.

Slide the frame forward or backward through the clamps to the desired position.

If the frames are too hard to move, loosen the bolts as much more as it is necessary.

It may be possible to scratch the frame, so it is advisable to proceed with care without forcing the system.

It is possible to adjust the setting every millimetre.

Once reached the desired setting, tighten the bolts **A** and **C** on one side first. Then, from the inner side of the frame, measure the distance **X** between the rear side of the rear clamp and the backrest plate. Adjust and fix the other side respecting the same distance.

When tightening each bolt, check that the inner plate of the clamp does not turn (you can hold it with your fingers), in fact, if it turns, the clamp will not take hold of the frame properly.

Remember that the setting adjustment can affect the seat inclination, so it is necessary to check and adjust the fork angle.

The predetermined settings that appear in the order form have the following distance **S** (from the backrest's axis to the wheel's axis): Prudential 9.0 cm; Standard 10.5 cm; Active 12.0 cm; Extreme 13.5 cm

Following the instruction above, you can reach a particularly prudential setting approx. 5 cm (distance **X** = 0, rear clamp in contact with the backrest plate).

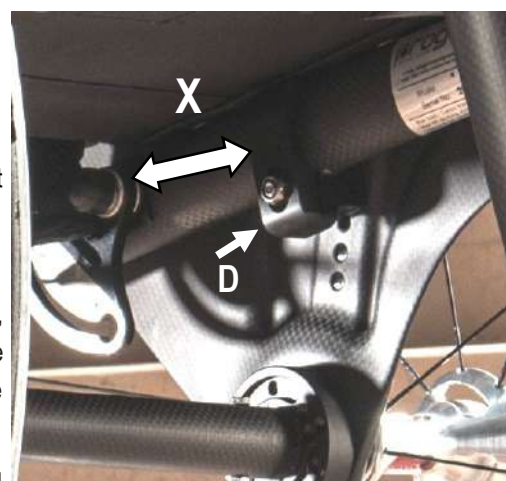



CAMBER AND CONVERGENCY

SERVICE MANUAL

WORK ON A FLAT AND EVEN SURFACE

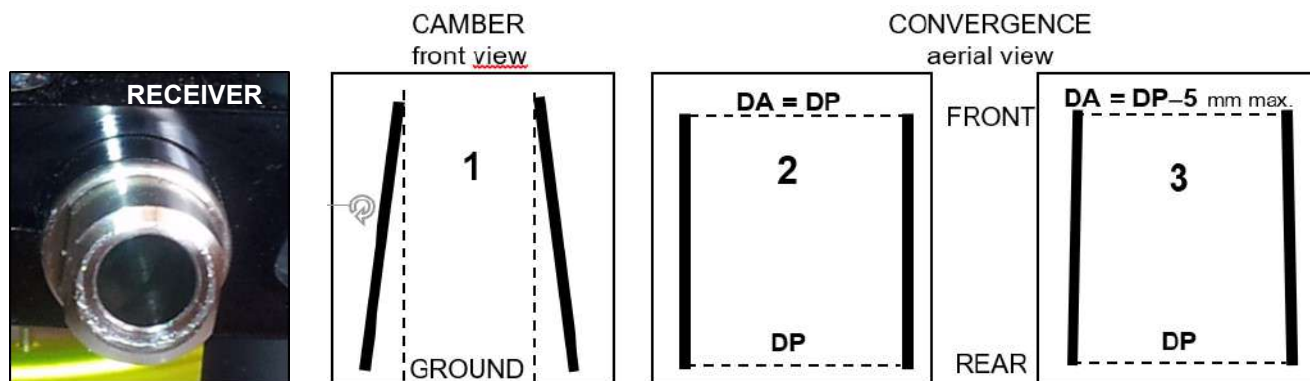

The wheel receiver gives the rear wheel camber (cambered receiver).

The two wheel receivers are fixed to the rear axle, thus, to adjust the convergence, it is necessary to turn the axle.

The drawing 1 shows same inclination (camber) of both rear wheels.

With cambered wheels, it is necessary to check/adjust the convergence, the distance between the two wheels in front and at rear.

The drawing 2 shows the aerial view of the wheels and the front distance **DA** is equal to the rear distance **DP**, while the drawing 3, **DA** is narrower than **DP** by maximum 5 mm.

We can say that a good convergence has the **front distance DA** equal to or slightly narrower than the **rear distance DP**.

DA must not be wider than **DP**. In such case, the fluency of wheelchair will not be good.

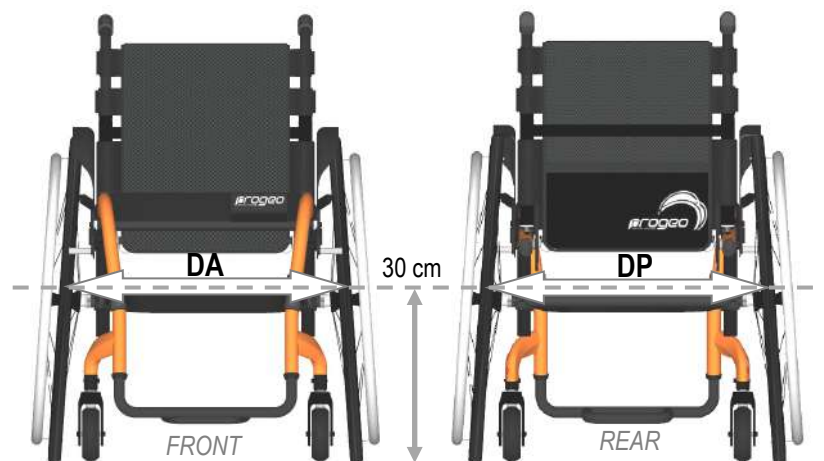
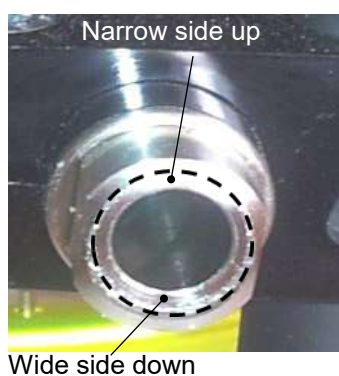

The hole of the cambered receiver, since it is inclined, is not centered.

Therefore, check the wheel receiver its narrow edge looking upward and its wider edge down. If opposite, the convergence is opposite, too (the wheels are opening apart at top!).

At 30 cm from the floor, take the measure centre-to-centre between the two tyres in front and at rear.

If the two measures are equal or the front one is slightly narrower (max. 5 mm), you have a good convergence as drawing 2 or 3.

If different, you have to adjust the convergence.

Se differente, è necessario regolare la campanatura.

Follows next page



CAMBER AND CONVERGENCY

SERVICE MANUAL

Standard rear unit

Full Carbon side plates

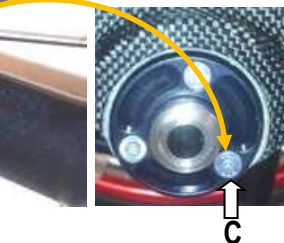
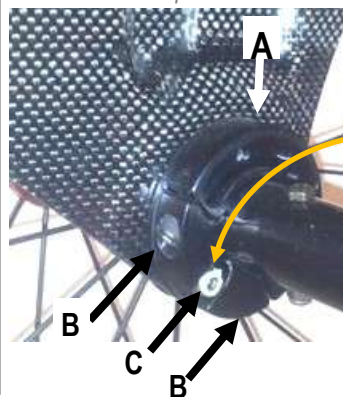

Standard rear unit: loosen the bolt **A** and then the grab screw **B**. The grab screw **C** is not involved in this adjustment.

Full Carbon side plates: loosen the grab screw **A** and the bolt/nut **C**.

Loosen the above mentioned screws just enough to let you turn the rear axle with your hand but without the clamp sliding along the axle. If that occurs, you can continue with the adjustment. You will fix that later.

Turn the rear axle (clockwise or anticlockwise) and observe how and to what extent the wheels move.

A good reference is the bolt **D**, in fact its axis, should be perpendicular to the ground, except for the 4° receiver fixed in the centre position (2) which is rotated by 90° with respect to the other two positions (1 and 3); in such case, the bolt **D** should be parallel to the ground.

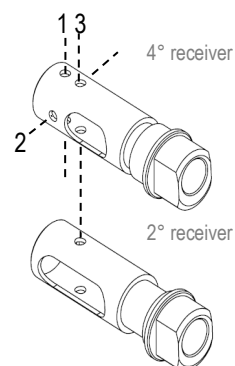
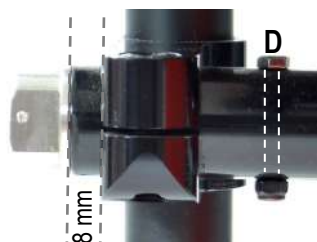
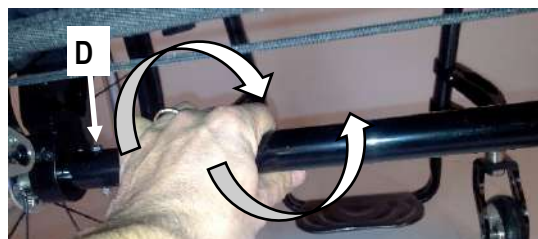

Take the measures again and if necessary, repeat the same operation until you reach the correct convergence, see previous page.

If the clamp moved when you loosened the fixing bolts, position the axle's end (not the receiver) at 8 mm from the clamp for the standard rear unit, or 5 mm if Full Carbon plate and fix one side, first.

Standard rear unit: tighten the bolt **A** and then the grab screw **B**.

Full Carbon side plates: first tighten the two bolts **B** alternatingly and then the bolt/nut **C**. Warning: if you reverse that sequence, the lock plate may crack in its thinner part. Finally, screw the grab screw **A**.

Before fixing the other side, check the front wheels (considered already adjusted at the same height) are both touching the ground. If one do not touch, turn the frame on axle on its loosened side to the necessary extent.

If the quick release axle of the rear wheel hardly or do not pass through the receiver, loosen **A**, **B** (and **C**) and remove it. Then, tighten all parts again, but first pass the hole with a 1/2" reamer to remove any possible tiny deformation (see also adjustment sheet "quick release axle").

It may be a little harder to position and fix the other side due to the pressure given by the seat canvas, but you have to respect the same distance.

Check the measure from a fix point of the frame to the centre of the tyre on each side. Should there be a difference greater than 2-3 mm, check the distance between clamp and axle as above mentioned.

If necessary, correct the adjustment.

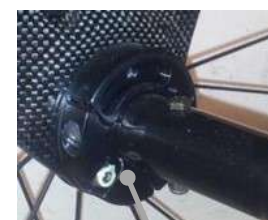
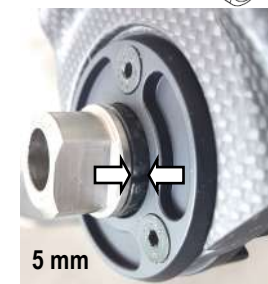



BRAKE

SERVICE MANUAL

WHEN ADJUSTING THE BRAKES, THE TIRES MUST BE INFLATED TO THE CORRECT PRESSURE (except solid tyre)

The position of the brake depends on the position of the rear wheel.

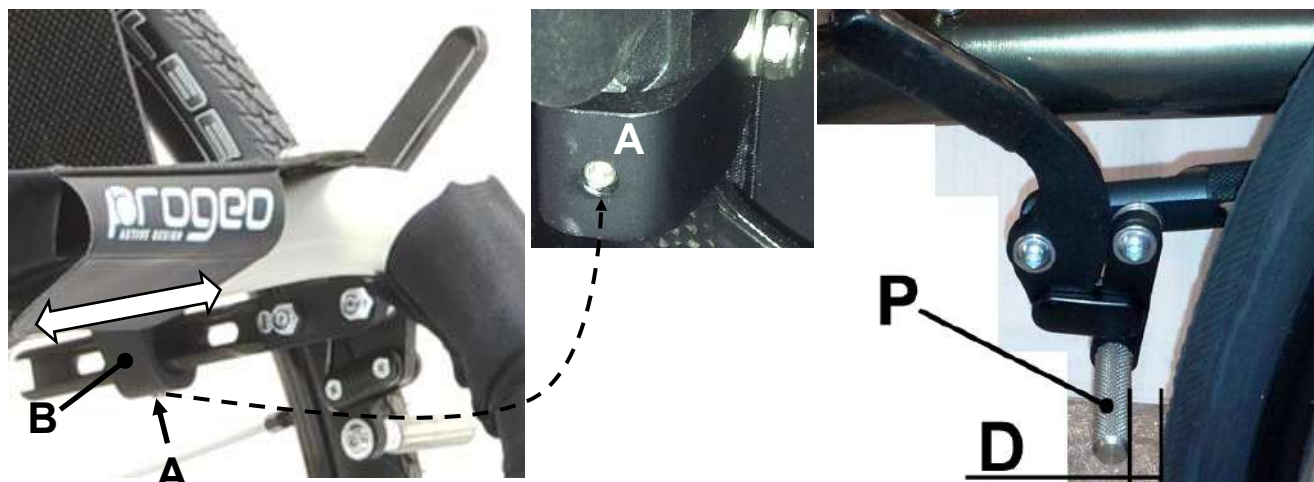

Loosen the headless bolt **A** located in the lower side of the support **B**.

Position the brake-knurled rod **P** at a distance **D** of a few millimetres and parallel to the ground.

Temporarily tighten the headless bolt **A** and try the brake out to check if the adjustment is good.

If necessary, repeat the same operation to reach the good adjustment.

A good adjustment has the brake not too hard to engage but braking, so you will have to find the suitable compromise.

Once reached the correct position, tighten the headless bolt **A**.

Carry out the same operation on the other side.

The adjustment for the sport brake is the same except for the distance **D**, in fact, the brake, in its resting position is far away from the tyre. Just make a few tries



Note: if the frame is rather short (short seat depth) there may be interference with the front curve of the frame. In that case, it is necessary to move the rear wheel backward (point of balance) as much as necessary (see adjustment sheet "setting")



BRAKE SPACING

SERVICE MANUAL

In several cases, the distance between the tyre and the frame can be such as to make need moving the knurled rod **P** more external.

When originally assembling the wheelchair, such possible modification is already taken into account.

In case of a post-sale modification that results in the rear wheels being more external (from 0° to 2° or 4° camber; seat width enlargement; a different wheel), the brake may not work efficiently anymore, therefore, you will have to move the knurled rod. The brake is efficient if the knurled rod **P** is at least 5 mm beyond the tyre's mid-line.

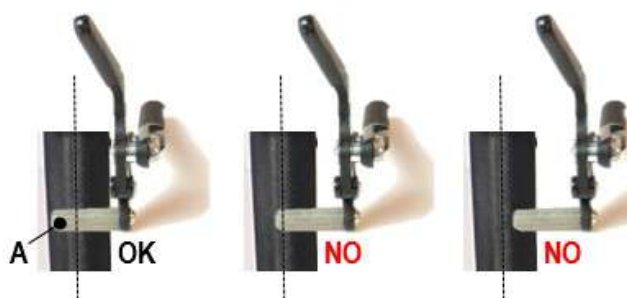

In all cases, check the brake efficiency.

Remove the bolt **B**. In order to remove it, put the knurled rod in a vice and heat it with a hot air blower because the bolt is locked with strong lock thread glue. DO NOT FORCE WHEN UNSCREWING IT, you may damage the bolt's head irremediably.

Once you have removed the bolt, the knurled rod comes off, too. Replace the bolt **B** according to the spacer **C** (7 or 11 mm) you will add.

Put some strong lock thread glue on the bolt **B** and assemble the spacer **C** and the knurled rod **A**.

Put the knurled rod in a vice and tighten the bolt **B** hard.

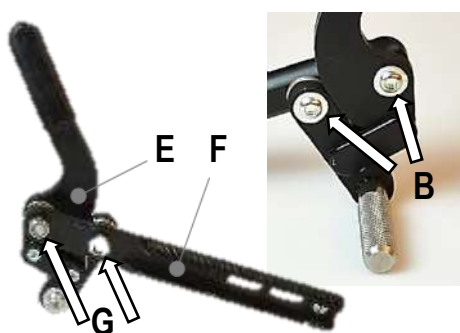
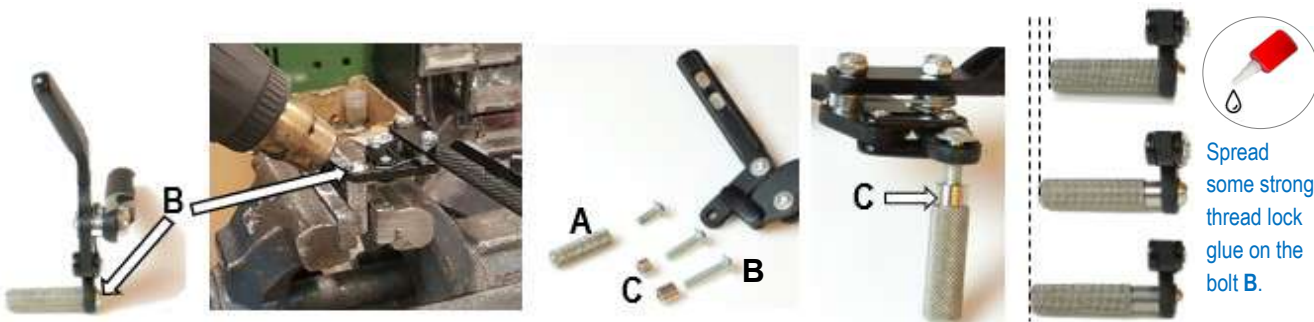

It is also possible to move the brake structure **E** from the adjustment rod **F**.

Remove the two nuts **G** and then the two bolts **B**.

Remove the spacers **H** around which the spring is assembled.

Observe how the spring is assembled because you will have to assemble it back later in the same way (you can always have a look at the other brake that is symmetric).

Insert the spacers **H** (H_1 = original; H_2 = 7 mm longer).

Position the spring and assemble the structure to the adjustment rod.

Start screwing the two bolts **B** all the way down and then the two nuts **G**.

Should the brake movement be hard, slightly loosen the bolts **B**.





SIDE GUARD

STANDARD REAR UNIT

SERVICE MANUAL

Whenever changing the rear height, you have to adjust the side guard. If the side guard is straight, you may leave it as it is.

The side guard should be adjusted at approx. 5 mm from the tyre and it is fixed to the front frame with the bolt/washer **V1** and to the adjustment post with the bolt/washer **V2**.

Each side guard is shaped to measure according to the configuration of the wheelchair when originally assembled.

The shape of the side guard always allow for a reasonable good margin of adaptation.

Bolts fixing

The bolt/washer **V1** is screwed into a threaded rivet fixed to the front axle **A**. When removing this bolt, the front clamp, made of the inner plate **B** and the brake support **C** (with the brake fixed to it), comes off the frame (if the axle turn when unscrewing **V1**, hold it with one hand). Note: with the carbon fibre rigid seat, the axle is not present and the bolt is fixed with a nut.

To assemble the parts, let the bolt/washer **V1** through the hole of the side guard and through the hole of the brake support **C**. Position the support **C** on the frame.

Position the plate **B** and screw the bolt **V1** into the axle **A**. Make sure the axle is cast into the housing of the plate.

While screwing the bolt **V1**, hold the axle **A** so that it will not turn and make sure the plate **B** is well leant against the frame.

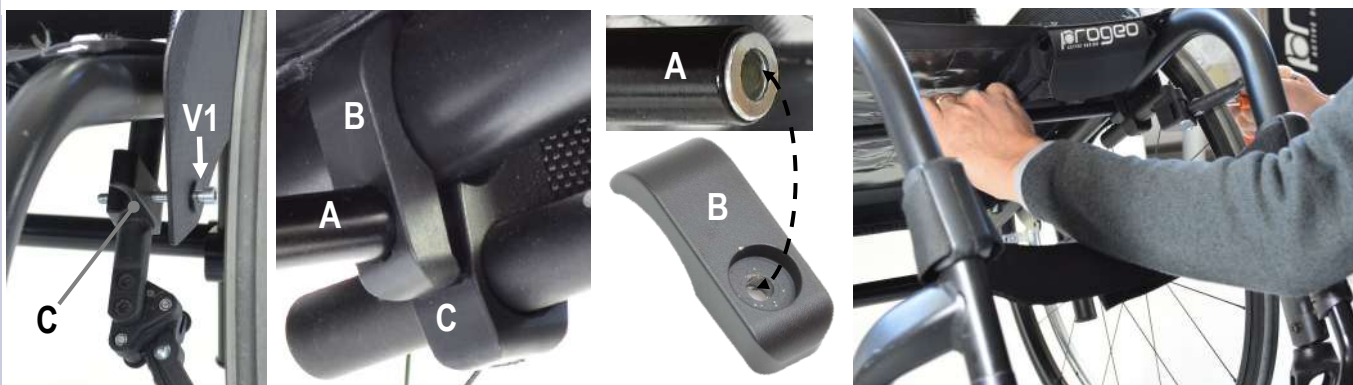
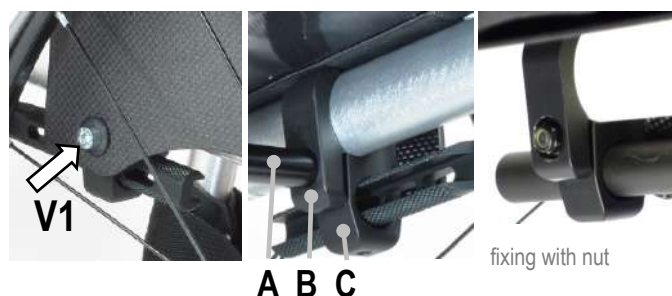

To fix the other side, the operation is quite the same, but it is advisable to insert the axle **A** into the housing of the plate **B** and lean it against the frame before positioning the support **C**.

This operation may need a little forcing due to the pressure given by the seat canvas.

Finally, tighten the bolt **V1**.

The bolt **V2** is fixed to the threaded hole of the clamp **D** of the adjustment post.

Take care when fitting the bolt **V2** with care to prevent damaging the thread of the threaded hole.



Follows next page



SIDE GUARD

STANDARD REAR UNIT

SERVICE MANUAL

When changing the setting (point of balance), it is not necessary to modify the side guard, see also adjustment sheet “setting”.

When increasing the rear height, you have to lower the side guard and bring it to approx. 5 mm from the tyre and parallel to it.

After the adjustment, put the rear wheel on and measure the distance **X** between the mudguard and the tyre. From that measure, take off 5-6 mm. The result will be the measure you will use as reference to mark the point where to drill the new hole for the bolt **V2**.

Example: if **X**= 31 mm; $31 - 6 = 25$; the new hole will have to be 25 mm above the existing one.

To mark the point, you can use a ruler. Position it parallel to the adjustment post and aligned with the axis of the bolt **V2**.

The distance centre-to-centre between the two holes must not be lower than 10 mm. If the necessary adjustment is less than 10 mm, you should drill the new hole at top right or top left until the two holes will be 10 mm from one another.

Remove both the bolt **V2** and **V1**.

Remove the side guard and drill a 6 mm hole where you marked for the **V2**.

On the front inner side of the sideguard, in order to make marking the point easier, you can put some sticky paper tape. Assemble the sideguard with **V2** and position it at 5 mm from the tyre and parallel to it.

While holding the support **C** with the brake well leant against the frame, mark with a point, a pencil or else, where you will have to drill the new hole.

Check that the point you marked is not too close to the edge of the side guard or to existing hole. In either case, move the support a few millimetres away and mark the point again.

Remove the **V2**, remove the side guard and drill a 6 mm hole where you marked it.

Mount the side guard fixing **V2** and then **V1**.

Repeat the same operations for the other side guard.

When decreasing the rear height, you have to move the side guard up.

The adjustment is limited to the lower edge of the side guard.

Usually, the margin is approximately 15-20 mm. If the side guard is straight, you can decide whether to modify it or not.

To mark the point where to drill the new hole, use a ruler likewise described above and taking into consideration the entity of the adjustment.

Therefore, if the adjustment is 15 mm, the new hole will be 15 mm below the existing one. If the adjustment is less, remember that the distance centre-to-centre between the two holes has to be at least 10 mm.

Between the new hole and the edge of the sideguard there must be at least 3 mm.

When changing both the setting and the rear height, proceed as if you are changing just the rear height.



At each adjustment, spread some mild lock thread glue on the bolts **V2**.

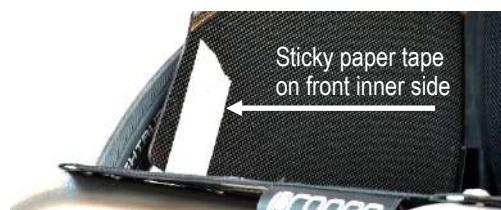
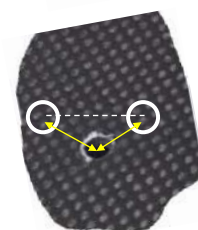
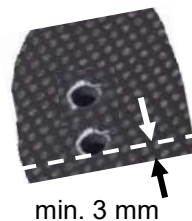
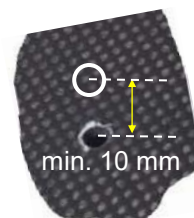

Mark the point where to drill the new hole

After the rear height adjustment, adjust, if necessary, the brakes, too.



REMOVABLE SIDE GUARD

STANDARD REAR UNIT

SERVICE MANUAL

After every adjustment of the rear wheel, you have to adjust the position of the side guard. You have to adjust the side guard at approximately 5 mm from the tyre.

The side guard is fixed to three points on the blade **A** that slides in the support **B** fixed to the frame.



HEIGHT ADJUSTMENT

The blade **A** shows, in its vertical side, a series of holes to fix the bolt **C** that inserts in the hollow **D** of the support **B**. Therefore, to change the height, just remove the bolt **C** and screw it in another hole.

Warning: do not tighten the bolt **C** excessively: it may damage the threaded hole until making it unusable.

SIDE GUARD MODIFICATION

If one, the other or the combination of both adjustment above mentioned are not satisfactory, you can modify the side guard. Every side guard is shaped to measure according to the configuration of the wheelchair when originally assembled.

The shape of the side guard always allow for a reasonable good range of adaptation.

Note: if the side guard is straight, you can decide to modify it or not.

A When you decrease the rear height, you have to move the side guard up.

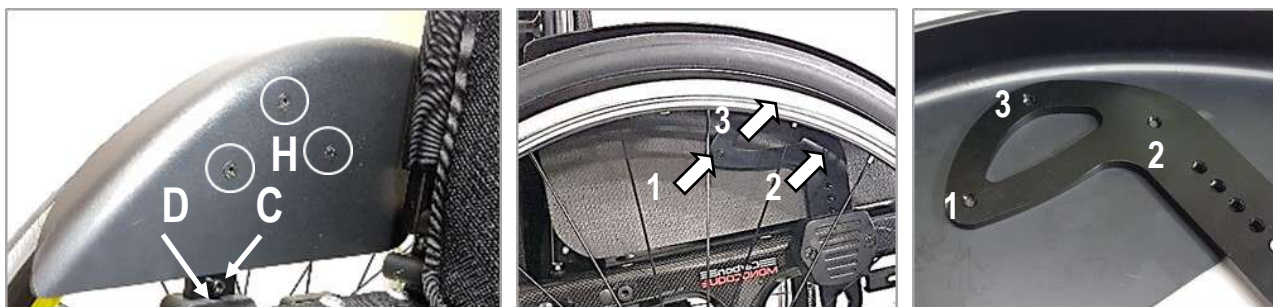

1. Remove the three bolts **H** to take the side guard off the blade.
2. Position the side guard at approximately 5 mm from the tyre, always leant on the blade **A**. The bolt **C** on the blade must be inserted in the hollow **D** of the support.
3. While holding this position, mark the point where it is necessary to drill the first new hole (1 or 2; 3 is usually not accessible with the rear wheel on).
4. To do so, use a point and let it through the accessible hole. If the rear height adjustment is remarkable, you may need a new sideguard.
5. Drill a 5 mm on the sideguard where you have marked it.
6. Countersink the hole.
7. Insert and screw the bolt **H**.
8. To drill the second hole on the side guard, follow instruction from 3 to 7.
9. To drill the third hole, remove the side guard, mark the point where to drill and follow instruction from 5 to 7.

Advice for drilling. While drilling a hole, such hole may result slightly moved with respect to the precise point you marked. For the first hole, that move does not cause any trouble. On the other hand, for the second and third hole, it may cause a non-alignment between hole on the side guard and hole on the blade. A good method to be more precise, once you reach point 5, is to use a 4 mm drill pin (in order to avoid damaging the thread of the hole on the blade) and drill the side guard. Then, use and let a M5 tap through the threaded hole of the blade and out of the side guard.



At each adjustment, spread some mild lock thread glue on the bolts **C** and **H**.

Follows next page



SIDE GUARD

STANDARD REAR UNIT

SERVICE MANUAL

B When you increase the rear height, you have to move the side guard down.

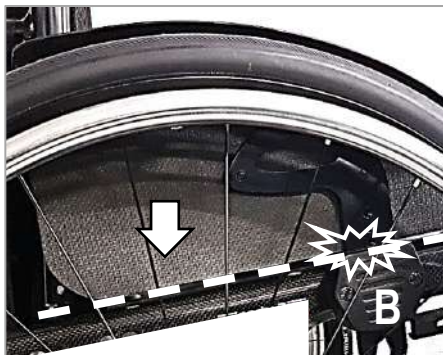
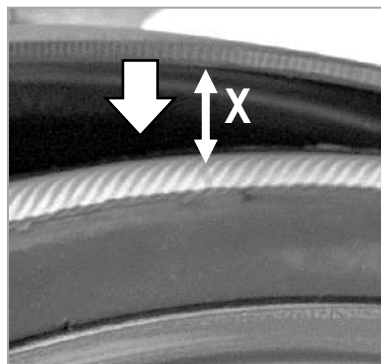

If the lower side of the side guard is in contact with the support, it is necessary to cut it.
Measure the distance **X** from side guard and tyre and subtract 5 mm (es: 18-5 = 13 mm to cut).

Remove the three bolts **H** to take the side guard off the blade.

Draw the cut line according to the result you got.

Saw the side guard along the drawn line and round off the edges with a scissors blade or thin sand paper.

Continue with instruction .

C When you change the setting, you have to move the side guard forward or backward according to the new position of the rear wheel, but the height of the side guard remains the same.

Proceed with instruction **A**.

D When you change both the rear height and the setting, you have to move the side guard up or down **and** forward or backward.

Continue with instruction **A** and, if necessary, instruction **B**, too



At each adjustment, spread some mild lock thread glue on the bolts **C** and **H**.



FOOTPLATE DISTANCE

Tubes with holes

SERVICE MANUAL

Adjustment every 1.5 cm.

Remove the bolts **A** and their corresponding washers and nuts **B**.

Slide the footplate tubes to the necessary height.

Make sure the two tubes are at the same height.

Insert and tighten the bolts.

After adjustment, check that between the lower side of the footplate and the ground there is at least 2 cm and that there is no interference between footplate and casters.

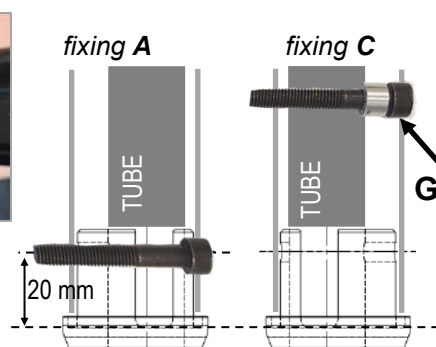
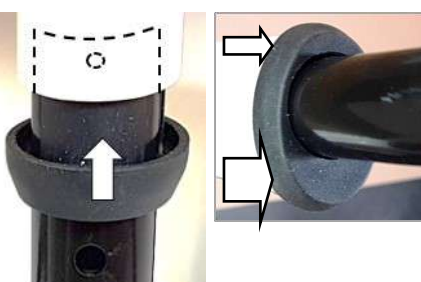

Rubber adaptor for round footplate tube on elliptical tube (from 2019).

The round footplate tube needs the adaptor **F** to fit the elliptical frame tube. The adaptor's hole is not centred, therefore, you have to pay attention to mounting right and let adaptors in the same way.

- If the centre of the fixing hole **A** is at 20 mm from the lower extremity of the frame tube, the adaptor **F** is usually mounted with its narrower side facing frontward. In order to avoid squeezing the adaptor too much, do not tighten the bolt very hard.
- If the centre of the fixing hole **A** is further than 20 mm, thus even the hole **C**, the adaptor **F** is glued to the frame and assembled with its narrower side backward. This is due to the fact that when you tighten the bolt, the tube will lean against the inner side (which is very close) of the frame tube and that guarantees the stability of the system. The bolt for this fixing includes a spacer **G** under the bolt's head. This way, the bolt will run in beyond the frame tube wall; if so, it would impede the correct fixing of the footplate tube. (This fixing is of course also possible if the point **A** is at 20 mm).
- To turn the adaptor, (if it is not glued), remove the footplate tube, slide the adaptor off and mount it reversed.

With elliptical footplate tubes, the adaptor is not present.

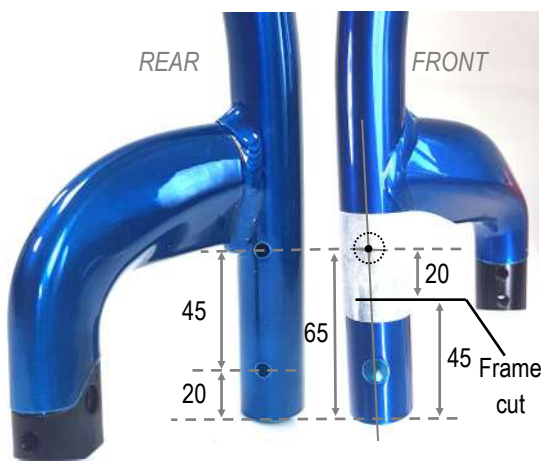

Note: the part of the frame below the fork support, according to the requested footplate distance, can be either 65 or, if the frame is cut, 20 mm long.

In both cases, the hole for the fixing bolt has to be 20 mm from the edge of the frame so that it will correspond to the hole of the adaptor. If the frame is not cut at origin, you can cut it off 45 mm afterwards. The 5 mm hole at the rear side is pre-drilled, whereas you will have to drill an 8.5 mm hole on the front side.

To drill that hole, you have to be very careful to centre it with the frame's axis as well as the rear hole's axis. It is advisable to mark the reference point before cutting the frame; put a piece of sticky paper tape on the frame and, with a pen or pencil, and draw the precise point, 65 mm from the edge, where to drill the hole. Now, always paying attention to the centring, drill a 3 mm hole first, then 6 mm and finally 8.5.



FOOTPLATE DISTANCE

Sliding system (until 2018)

SERVICE MANUAL

Adjustment with sliding system.

Loosen the bolt **A** of the clamp on both sides.

With a rubber or plastic mallet, gently hit on the upper or lower points that are indicated by the black arrows according to the adjustment you need to carry out.

Once you reach the desired height, tighten the bolt **A** on one side.

Check the wide side of the footrest plate is parallel to the ground.

If necessary, raise or lower the tube on the side that is not fixed yet. Finally, tighten the bolt **A** of the second side.

After each adjustment, check that:

Between the lower side of the footplate and the ground, there is at least a 2 cm gap.

There is no interference between footplate and casters.

The height adjustment of the footplate can affect the directionality of the wheelchair, in fact, if the footplate is slightly tilted on either side, the wheelchair will go right or left. In such case, correct the height of the right or left tube.

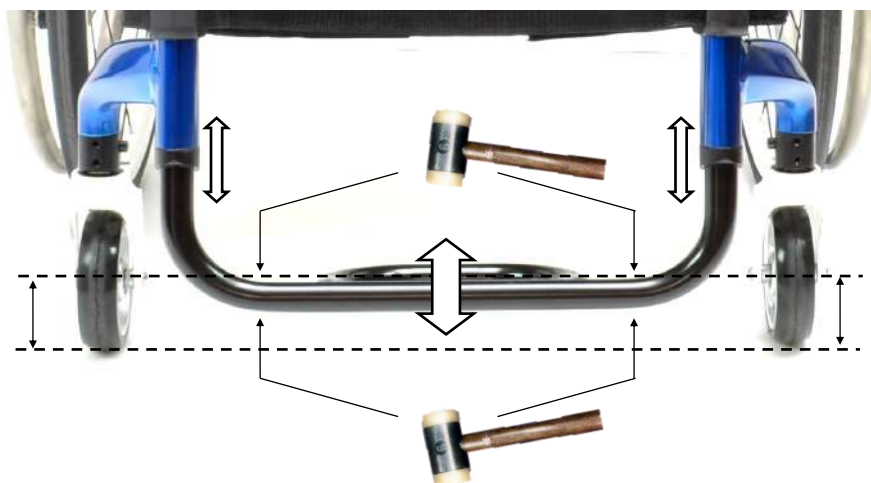
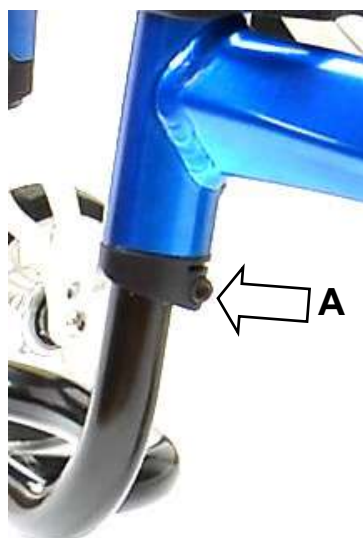



TUBULAR ALUMINIUM FOOTPLATE

SERVICE MANUAL

It can be provided with or without plastic plate.

Angle adjustment:

NOT adjustable in angle.



Position adjustment:

2 positions: internal; external.

To change position, remove bolts/washer/nuts that fix the footplate tubes to the frame (see “footplate distance”); remove the footplate and mount it reversed.

To make inserting the tubes easier, if possible, remove the rubber adaptor from the frame and slide it along the footplate tube; that will create more room for the passage of footplate tubes.

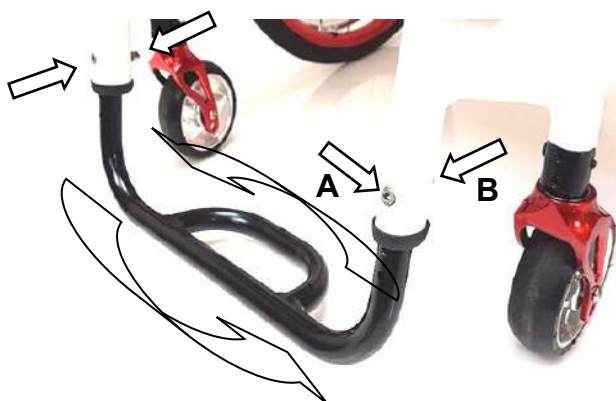
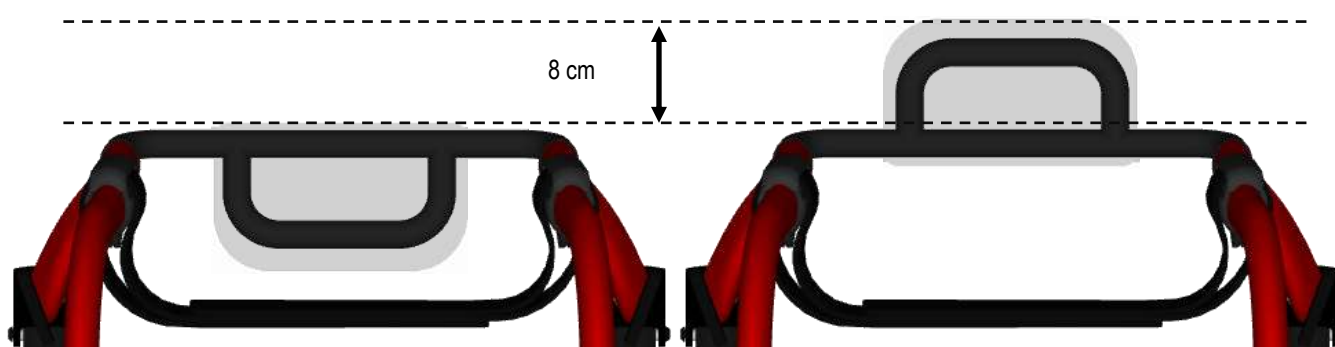



ALUMINIUM FOOTPLATE WITH CURVED TUBES

Angle adjustment:

Remove the two bolts and nuts **A** that fix the footrest plate to the clamp **B**.

Loosen the two bolts and nuts **C** that fix the clamp **B** to the two tubes.

Turn the clamp until the necessary inclination.

Lay the footrest plate on the clamp to check the inclination.

Firmly tighten the bolts and nuts **C**.

Finally. Fix the plates with the two bolts and nuts **A**.

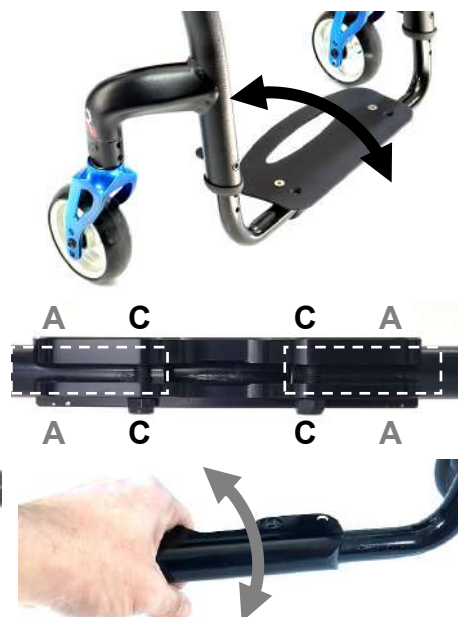
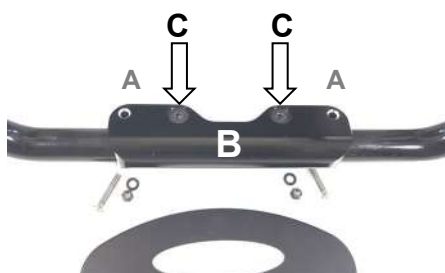
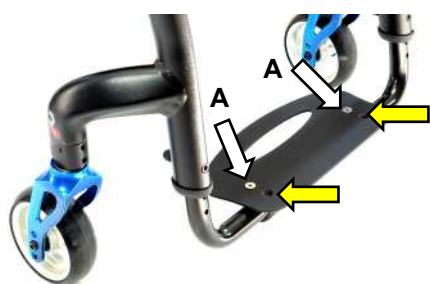

Position adjustment:

4 positions: internal; 2/3 internal; 2/3 external; external

Remove the two bolts and nuts **A** and fix the plate using the other two holes on the same plate. You can also fix the plate facing front or rear without the need (even though possible) of reversing the clamp.

If you wish to reverse the clamp, remove the bolts/washer/nuts fixing the footplate tubes to the frame (see "footplate distance") and remove the footplate.

Reverse the assembly, fix the tube at the necessary height and adjust the angle as above mentioned.

To make inserting the tubes easier, if possible, remove the rubber adaptor from the frame and slide it along the footplate tube; that will create more room for the passage of footplate tubes.

It will be necessary to adjust the inclination.

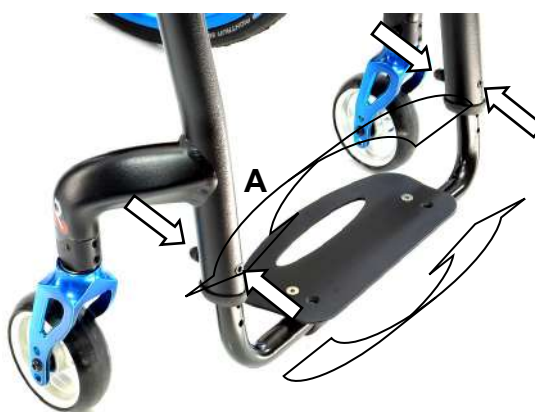



ALUMINIUM FLIP-BACK FOOTPLATE

SERVICE MANUAL

Angle adjustment

Raise the plate.

The arms **A** allow for raising the plate, but they are not involved in the angle adjustment.

The clamp **B** is the component that allows for angle adjustment.

Loosen the two grab screws **D** and the four bolts **C**.

With one hand, turn the clamp to the desired inclination.

Swing the plate down and let it rest on the clamp to check its inclination.

If you need more inclination, repeat the steps you made so far.

If you need less inclination, you can now simply push the plate down until the desired inclination.

Finally, raise the plate and tighten the bolts **C** first and then the grab screws **D**.

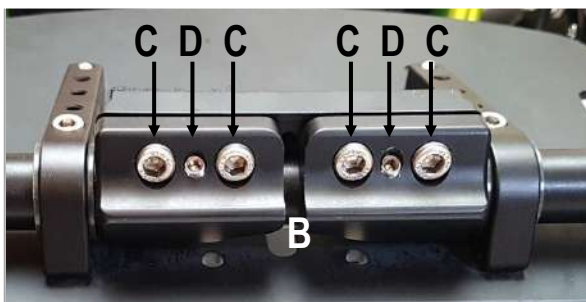
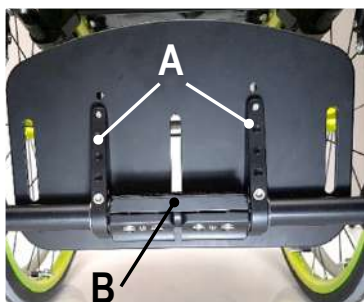

Regolazione in profondità

The plate is fixed to the rotation arms **A** with four bolts **B**.

The plate has six pre-drilled holes, whereas, the arms have five pre-drilled holes.

To change the position of the plate, remove the four bolts **B**.

Move the plate forward or backward to the new position.

Insert and fix the four bolts **B** positioning them, as far from each other as possible.

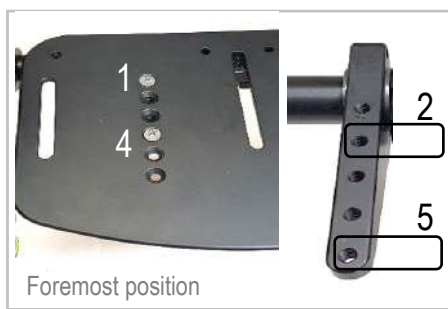
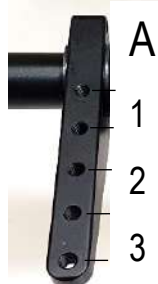
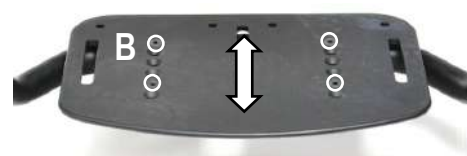

Foremost position



Rearmost position

The foremost position of the plate is given when you fix it through its holes 1 and 4 and those of the arm **A** 2 and 5.

DO NOT position the plate more forward than the provided foremost position: the plate will not lean over the clamp below.

The rearmost position of the plate, you have to fix the plate through its holes 4 and 6 and the arm's **A** 1 and 3.

DO NOT position the plate more backward than the provided foremost position: the points of the arms **A** will lean out of the plate.

Note: between the foremost and the rearmost positions, there are 6 cm.

Friction of flip-back movement

The arms **A** allow for raising the plate and you can adjust them in order to make the movement more or less fluent.

You can adjust the movement by screwing (harder movement) or unscrewing (lighter movement) the two bolts **E**.

If you tighten the two bolts hard, the plate will results nearly fixed.



At each adjustment, spread some mild lock thread glue on the bolts **B**.



CARBON FIBRE FOOTPLATE

SERVICE MANUAL

Angle adjustment:

Loosen the grab screw **A** and the bolt **B** of both supports (right and left) just enough to be able to turn the footplate.

Adjust the inclination of the plate until the necessary angle.

Finally, tighten the bolt **B** first and then the grab screw **A** of both supports.

Note: the supports for elliptical tube and for round tube have the same bolts.

Position adjustment:

2 positions: internal; external

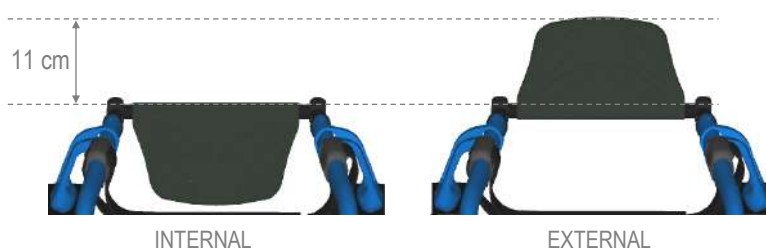

Remove the bolts/nuts that fix the footplate tubes to the frame (see "footplate distance") and remove the footplate.

Reverse the assembly, fix the tube at the necessary height and adjust the angle as above mentioned.

To make inserting the tubes easier, if possible, remove the rubber adaptor from the frame and slide it along the footplate tube; that will create more room for the passage of footplate tubes.

It will be necessary to adjust the inclination.

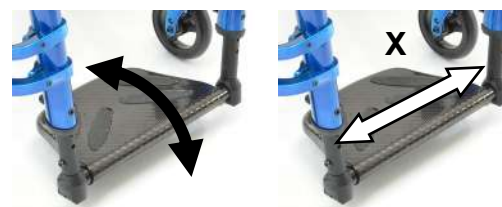
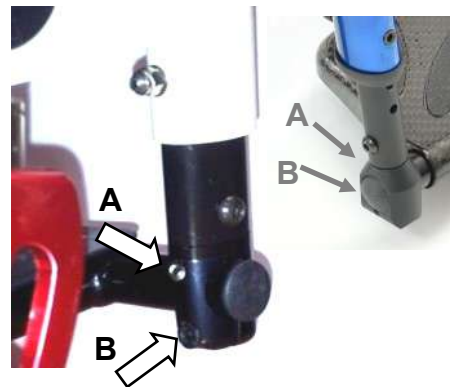



“U” TUBE ALUMINIUM FOOTPLATE

SERVICE MANUAL

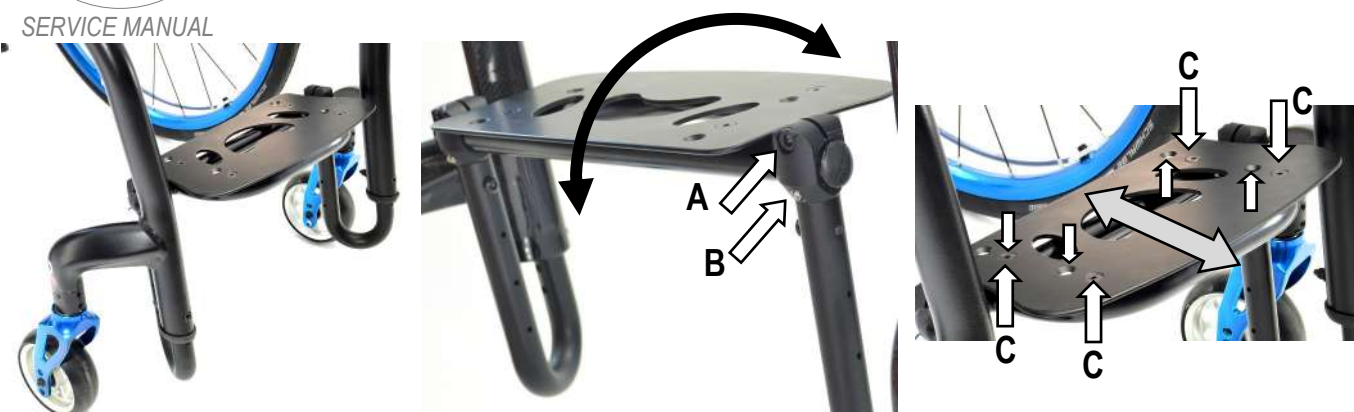

Angle adjustment:

Loosen the bolt **A** and the grab screw **B** of both supports (right and left) just enough to be able to turn the footplate. Adjust the inclination of the plate until the necessary angle. Finally, tighten the bolt **A** first and then the grab screw **B** of both supports.

Position adjustment:

The “U” tubes are always mounted facing backward, whereas the footplate tubular facing forward. The footrest plate, with respect to the footplate tubular, can be fixed in two positions. To change position, remove the 4 bolts **C**, move the plate and fix it using the other set of holes.

Other configurations are possible (not present in the order form), in fact, both the “U” tubes and the footplate tubular can be facing forward and backward.

To reverse the entire footplate group (see pictures 1, 2 and 4), remove the bolts/washers/nuts that fix the footplate tubes to the frame (see “footplate distance”) and remove the footplate.

Reverse the assembly of the entire group and fix it to the necessary height. You will need to adjust the angle.

To reverse only the position of the footplate tubular (see pictures 1, 2, 3 and 5 or 4, 2, 3 and 6) remove the entire footplate group as above mentioned.

Loosen the bolts **A** and the grab screws **B** until you can slide the two tubes off the footplate tubular.

Reverse the assembly without tightening the bolts and grab screws. Insert the tubes to the necessary height.

Centre the footplate and adjust the angle as above mentioned while paying attention to keeping the two tubes parallel to each other.

To make inserting the tubes easier, if possible, remove the rubber adaptor from the frame and slide it along the footplate tube; that will create more room for the passage of footplate tubes.



1 Tubes facing backward and footplate forward

2 Footplate group Disassembled group

4 Tubes facing forward and footplate backward

5 Tubes and footplate facing backward

6 Tubes and footplate facing forward

In addition to the height adjustment holes, the “U” tubes has other holes (**H**) meant to fix the footplate adjustment support.

You can cut off, every 3 cm, the part of the tube where you fix the support. You will need to enlarge the predrilled hole to 6 mm and fix the support with the bolt (spread some thread lock glue).

This operation may be necessary:

- 1) you need to increase the footplate distance, but the holes for height adjustment do not allow to do so.
- 2) to avoid interference between the curve of the tube and the caster's rotation, in fact, you can adjust the curve higher and the part of the tube with the support short in order to keep the same footplate distance of a configuration with the curve low and the support tube long.





SERVICE MANUAL

BACKREST HEIGHT

Aluminium or titanium backrest

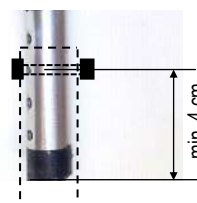

Remove the backrest upholstery and slide up the protecting sleeves of the backrest bands along the tube until the fixing screws are visible.

If the bolt is not accessible, remove the mudguard if it is removable or tilt the backrest backward by means of its adjustment system (see backrest angle adjustment sheet).

Remove bolt and nut **A** and raise or lower the backrest tubes to the desired height.

If the minimum height you can reach is not enough, it is necessary to cut the lower side of the.

If the maximum height you can reach is not enough, it is necessary to change the tube.

Warning: to guarantee a good stability, between the fixing hole and the lower side of the tube, there should be at least 4 cm. If the tube is cut, the lower hole will be only a few millimetres from the end of the tube; therefore, you should not use that hole, the next and, sometimes even the third to fix the backrest height.

Replace the screws and tighten.

To reduce possible play and possible noise, you can put some sticky tape around the inner tube at its bottom and at its fixing point (or just under it).

Note: if the backrest tube is in carbon fibre, follow the instructions of the adjustment sheet "*backrest height—carbon fibre backrest*".

The titanium backrest structure includes a plastic adaptor, just follow the same instructions above.





SERVICE MANUAL

BACKREST HEIGHT

Carbon fibre backrest

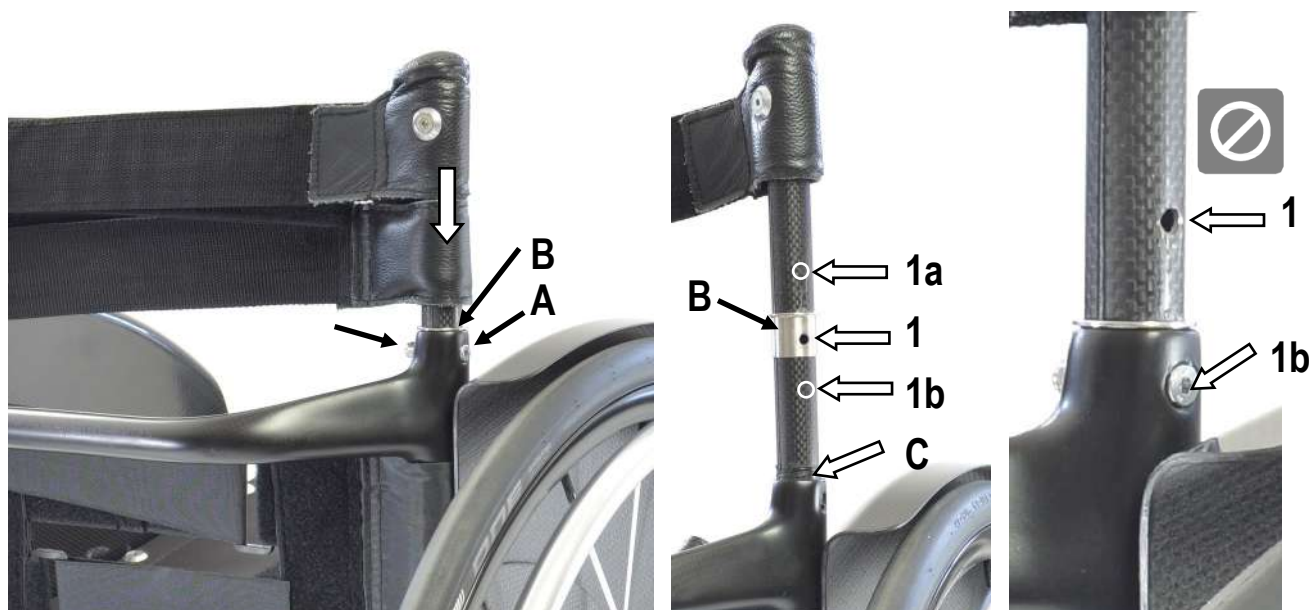

Remove the backrest upholstery and slide up the protecting sleeves of the backrest bands along the tube until the fixing screws **A** are visible.

In the fixing point, you will also see a steel buckle **B**.

If the bolt is not accessible, remove the mudguard if it is removable or tilt the backrest backward by means of its adjustment system (see backrest angle adjustment sheet).

Remove bolt and nut **A**.

The backrest tubes have only one hole that is originally drilled according to the height requested in the order form.

On the pictures above, you can see that the fixing point is the **1**.

The point **1a** could be a new hole to lower the backrest height and that is possible without creating problem (you may need to cut off the bottom side of the tube), in fact, the hole **1** will be underneath and within the tube of the backrest structure. While drilling the hole on the tube, pay attention to aligning the handle grip (if present).

Should you cut off the bottom side the tube, insert the buckle **B** on the tube and put a few turns of sticky tape **C** around the extremity of the tube to reduce a possible play.

Insert bolt and nut **A** and tighten **without overtightening** to avoid damaging the carbon fibre.



The **1b**, on the other hand, would be the point where to drill a new hole to increase the backrest height, but, by doing so, the hole **1** would be out of the backrest structure and it would create a situation of possible breakage of the tube during normal use of the wheelchair. This operation is not allowed.

Warning: to guarantee a good stability, between the fixing hole and the lower side of the tube, there should be at least 4 cm.



The carbon fibre backrest tube is not suitable to fixing any clamps, such as those used for a postural system hardware.

Note: if the backrest tube is assembled on a aluminium or titanium backrest structure, follows these same instructions.



SERVICE MANUAL

BACKREST ANGLE

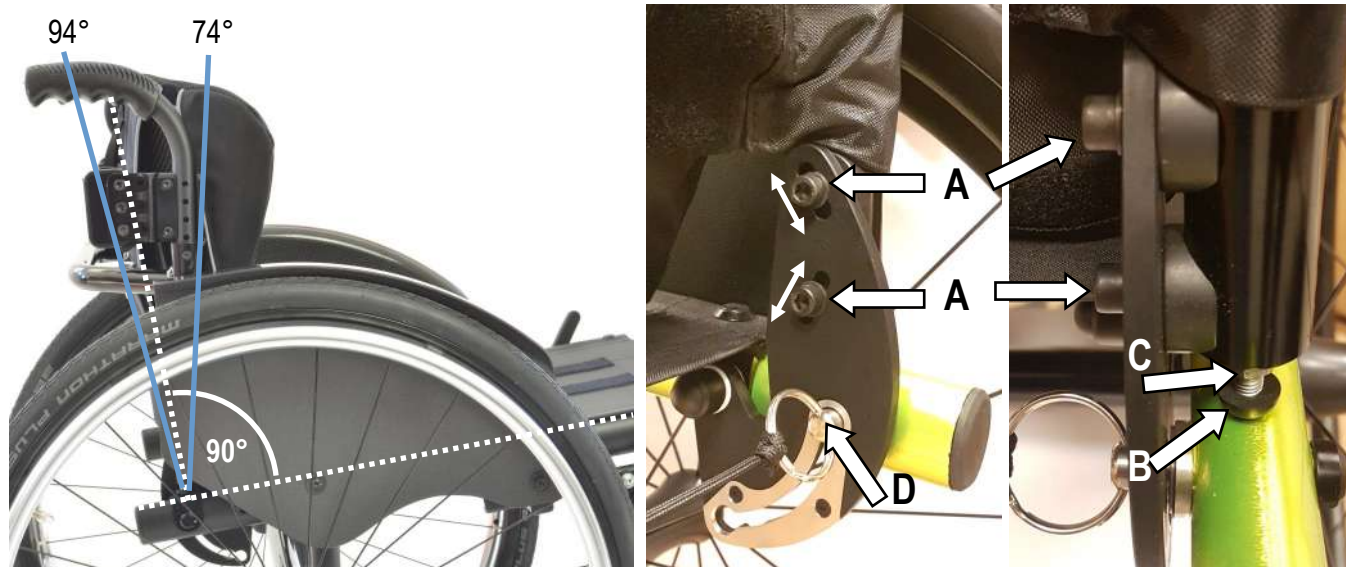

Adjustment from 16° close, tilted forward (74°) to 4° open, tilted backward (94°) with respect to 90° to the seat.

If you need to open (tilt backward) the angle, before proceeding, with the adjustment, fold the backrest, loosen the nut **C** and screw the bolt **B** that determine the end run, that is the point where it will lean on the frame. Such operations are not necessary when you need to close (tilt forward) the angle.

The adjustment can be performed thanks to the two bolts **A** sliding along the slots through which they pass and fix the backrest tube.

Therefore, loosen the two bolts **A** on both backrest plates, tilt the backrest to the desired inclination and securely tighten the bolts.

Now check the locking system.

If the locking pin **D** does not lock, or there is too much play, it is necessary to adjust the end run bolt **B**.

Loosen the nut **C**, fold the backrest and screw or unscrew the bolt **B**.

Open the backrest and check if it locks and its play.

To check the play, with the locked backrest, gently pull back it and forth.

If the play is still a lot, loosen the bolt **B**, whereas, if the backrest does not lock, screw the bolt **B**.

The correct adjustment is when the pin locks and the play is minimum. Then screw the nut **C** towards the tube.

Not only does the end run bolt **B** reduce the backrest play, but also it is very important as point of support of the backrest. In fact if it is badly adjusted (a lot of play) the lock pin **D** will support all the backrest stress and it may be damaged or even brake.

Remember that the backrest angle can affect the point of balance of the wheelchair. In fact, with tilted backward backrest (open angle), the wheelchair becomes less stable.



SEAT WIDTH ENLARGEMENT

SERVICE MANUAL

You can enlarge the seat by maximum 5 mm each side by modifying the side guard fixing.

This is possible by means of proper 5 mm spacers **A** to mount between the side guard and the frame.

The bolt **V1** remains the same.

The bolt **V2** has to be changed with a 5 mm longer one.

To assemble the side guard, follow the instructions of the adjustment sheet "side guard".

Warning: if the bolt **V2** is too long, even 1 or 2 mm, its point may touch the frame before tightening the side guard. Should that happen, file the bolt's point down or add an extra washer under the bolt's head.

Do not continue to screw the bolt if it is too long because you risk to damage the thread of the hole.

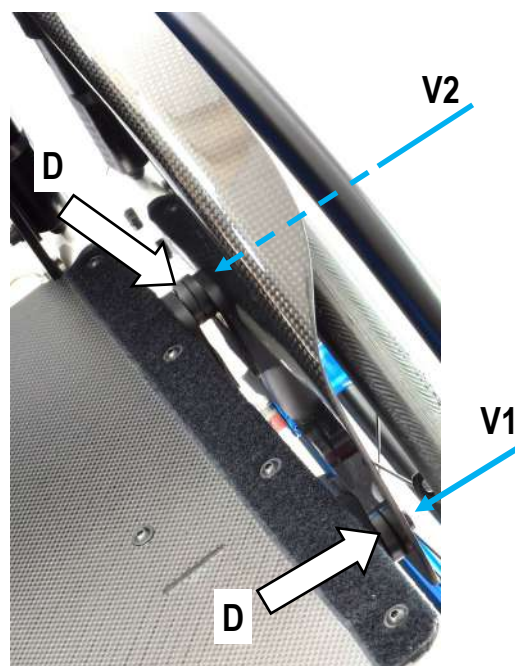
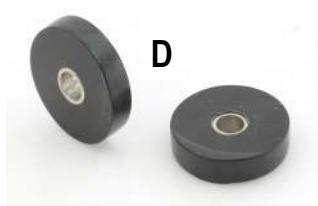

At each adjustment, it is advisable to spread a drop of mild lock thread glue on the bolts **V2**.



QUICK RELEASE AXLE

(rear wheel)

SERVICE MANUAL

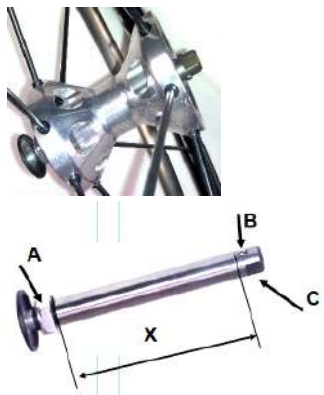

Adjust the quick release axle so that the rear wheel is safely fixed with no risk that it comes off accidentally.

At the same time, there should be no or very little play.

To check if the rear wheel is safely fixed, take hold of the hub without pressing the release button, and try to pull the wheel in and out.

As regular maintenance, it is advisable to clean the quick release axle and spread a little of grease on it.

If the wheel comes off, the distance **X** between the nut **A** and the balls **B** is too short, therefore, it is necessary to unscrew the nut **A** while holding the point **C** of the axle. **If there is play**, the distance **X** between the nut **A** and the balls **B** is too long, therefore, it is necessary to screw the nut **A** while holding the point **C** of the axle

In both cases, make a few tries until the correct adjustment. There is no need to remove the axle from the wheel.



It may happen that you adjust the axle so that the wheel only seems properly fixed, but it is not safe.

In fact, to check the adjustment, you have also to try to press the button just a little bit (as guidance, ¼ of its run) and pull the wheel. If it comes off, it means that it may come off while driving! Therefore, this is a very important **safety check**.

If the wheels comes off, unscrew the nut a little bit until you have the proper adjustment.

If the wheel (the axle) gets stuck in the receiver, you can proceed in two ways:

Press the quick release button, pull the rear wheel and, at the same time, with a mallet, gently hit (a little harder if necessary) the hub or spokes of the wheel and try to remove it.

Loosen the grab screw **A** and try to remove the wheel .

Loosen the bolt **B** (*Standard rear unit*; the grab screw **X** on is not involved) or the two bolts **B** and the bolt/nut **C** (*Full Carbon plate*) and try to remove the wheel.

If you have loosened both the grab screw **A**, the bolt **B** and the bolt/nut **C** (only Full Carbon plate), fix the bolts **B** first, then the grab screw **A** and finally the bolt/nut **C** (see also sheet "camber and convergency").



Standard rear unit

Full Carbon side plate

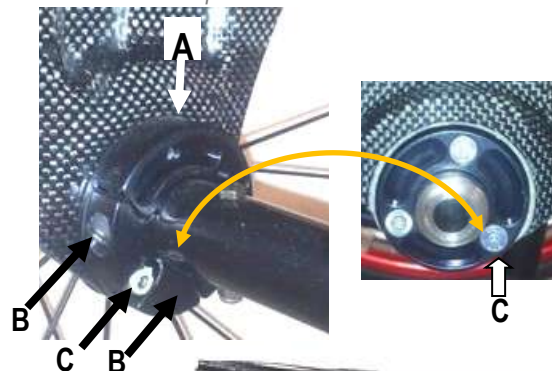
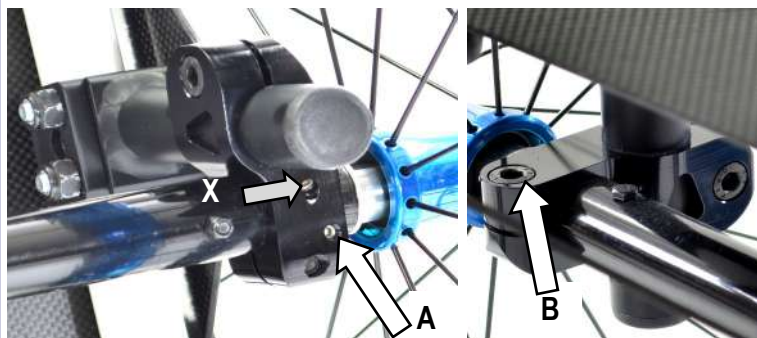

The reasons why the wheel can get stuck can be two.

- the receiver is slightly damaged; in this case, with a ½ reamer, re-pass the receiver's hole.
- when pushing the axle's button, the balls do not fall inside the axle's shaft; first, clean the axle, then try to push the button a few times a see if you have solved the problem; if not, press the button, hold the axle's pin with a wrench and unscrew the button half of a turn. Check and if necessary do the same with another half turn. Do not unscrew the button too much: the pin will come off and, consequently, the balls will fall to the ground.

