

Deliver to:
 Name:
 Street:
 Town: Postal code:
 E-Mail:
 Tel: Fax:

Order date:
 Purchase order:

Deliver to:
 Name:
 Street:
 Town: Postal code:
 E-Mail:
 Tel: Fax:

Marked for:

Base Price
£1,997

Fax number: **+44 (0)845 605 66 89**
 Email: **orders@sunmed.co.uk**
 Max User Weight 85Kg
Crash tested and Passed

Part No. 843900001-000 PQR01

CLIENT MEASUREMENT

Seat width in cm

		22	24	26	28	30	32	34	36	38	40	
Seat depth in cm	24	○	○	○	○	○	○	○	○	○	○	
	26	○	○	○	○	○	○	○	○	○	○	
	28	○	○	○	○	○	○	○	○	○	○	
	30	○	○	○	○	○	○	○	○	○	○	
	30	○	○	○	○	○	○	○	○	○	○	
	32	○	○	○	○	○	○	○	○	○	○	
	34	○	○	○	○	○	○	○	○	○	○	
	36	○	○	○	○	○	○	○	○	○	○	
	38	○	○	○	○	○	○	○	○	○	○	
	40	○	○	○	○	○	○	○	○	○	○	

+ 2 cm Short frame
 + 4 cm Depth growth only available on long frame
 Straight frame starting at 26cm

Your rear seat height can only be between 0 cm and 12 cm below your front seat height:
 i.e. rear seat height CANNOT be above front seat height
 i.e. rear seat height CANNOT be more than 12 cm below front seat height
 - More info, see first back page
 4" & 5" solid, 4" & 5" soft roll and 5" & 6" soft solid are only available with a 45 mm fork

Front seat height in cm

	Fork (length x width)	37	38	39	40	41	42	43	44	45	46	47	48	50
Front Castor	4"	111 mm x 45 mm		○	○	○	○							
		123 mm x 45 mm (3) (5)			○	○	○	○						
		111 mm x 32 mm	○	○	○	○	○							
		138 mm x 45 mm (1)					○	○	○	○				
		174 mm x 45 mm (1) (2)							○	○	○	○	○	○
	5"	111 mm x 45 mm				○	○	○						
		123 mm x 45 mm (3) (5)				○	○	○	○					
		111 mm x 32 mm				○	○	○						
		138 mm x 45 mm (1)						○	○	○	○			
		174 mm x 45 mm (1) (2)							○	○	○	○	○	○
6"	111 mm x 45 mm						○	○						
	123 mm x 45 mm (3) (5)						○	○	○					
	138 mm x 45 mm (1)						○	○	○	○				
	174 mm x 45 mm (1) (2)								○	○	○	○	○	

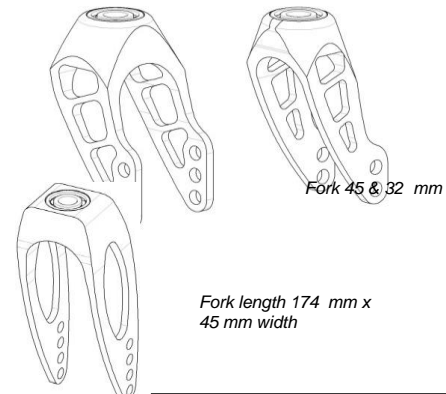

- Please note the procedure of the measurement is from the back
 - All measurements are in cm and without a cushion

Rear seat height in cm

	Wheels	32	33	34	35	36	37	38	39	40	41	42	43	44	45	46	47
Rear wheel	20" (4)	○	○	○													
	22"				○	○	○	○	○	○	○	○	○	○	○	○	○
	24"									○	○	○	○	○	○	○	○

(1) Aluminium rim only (2) only grey available (3) fork compatible with additional drive (4) only Proton wheels/Right Run/Steel Handrim (5) Not available with Carbotexture Fork

								£	
SEAT UPHOLSTERY									
Seat sling									
YNG020101	<input type="radio"/>	1 Utility bag						(Std default option)	
YNG020102	<input type="checkbox"/>	With two utility bags						(only from SW 34 cm)	54
YNG020103	<input type="checkbox"/>	One utility bag and one catheter bag						(only from SW 34 cm)	84
YNG020104	<input type="radio"/>	Without seat sling							
For JAY Seating, see JAY order form									
Seat cushion with cover, black									
a) Foam composite		Thickness:	YNG020201	<input type="checkbox"/>	3cm	YNG020203	<input type="checkbox"/>	5cm (medium)	64
b) Latex		Thickness:	YNG020202	<input type="checkbox"/>	5cm	YNG020204	<input type="checkbox"/>	8cm (very soft)	64
Seat cushion with water resistant / breathable cover									
a) Foam composite		Thickness:	YNG020205	<input type="checkbox"/>	3cm	YNG020207	<input type="checkbox"/>	5cm (medium)	122
b) Latex		Thickness:	YNG020206	<input type="checkbox"/>	5cm	YNG020208	<input type="checkbox"/>	8cm (very soft)	122
YNG020302	<input type="checkbox"/>	Spare cushion cover with zipper							37
Seat accessories									
YNG020301	<input type="checkbox"/>	Positioning belt with lock							42
YNG020303	<input type="checkbox"/>	JAY Fit belt 90° attachment	(attached to the seat rail)			(starts with SW 26; use with cushion only)			59
YNG020304	<input type="checkbox"/>	JAY Fit belt 45° attachment	(attached to the seat rail)			(starts with SW 26; use with cushion only)			
BACKREST									
Backrest (range)		22.5 - 27.5	27.5 - 32.5	32.5 - 37.5	37.5 - 42.5				
Back height set at (cm)		<input type="radio"/> 22.5	<input type="radio"/> 27.5	<input type="radio"/> 32.5	<input type="radio"/> 37.5				
		<input type="radio"/> 25	<input type="radio"/> 30	<input type="radio"/> 35	<input type="radio"/> 40				
		<input type="radio"/> 27.5	<input type="radio"/> 32.5	<input type="radio"/> 37.5	<input type="radio"/> 42.5				
Backrest frame									
YNG030101	<input type="radio"/>	Standard: Non angle adjustable (90°), non folding backrest							
YNG030102	<input type="checkbox"/>	Angle adjustable (Only in combination with side guard YNG040202)						185	
		<input type="checkbox"/> 87°	<input type="checkbox"/> 90°	<input type="checkbox"/> 95°	<input type="checkbox"/> 100°	<input type="checkbox"/> 105°			
		<input type="checkbox"/> Built-4-Me Option: Reclining back (For seat depth 30 cm and above)						586	
		Infinite back recline from -3° to +20°; price includes side guard, no fender available (2) (additional 10 day lead time)							
Push handles									
YNG030201	<input type="radio"/>	Without push handles (not in combination with half folding back)							
YNG030203	<input type="radio"/>	Long							
YNG030204	<input type="checkbox"/>	123 mm x 45 mm (3) (5) (only up from BH 32,5 cm)						133	
YNG030205	<input type="checkbox"/>	Height-adjustable push handles (only up from BH 30 cm)						185	
YNG030206	<input type="checkbox"/>	Height-adjustable push handles side angled (not in combination with drum brakes)						216	
YNG030207	<input type="checkbox"/>	JAY Hardware with height adj. push handles (only up from BH 30 cm)						178	
		123 mm x 45 mm (3) (5)			s				
YNG030316	<input type="radio"/>	EXO Backrest sling, synthetic fibre, padded, adjustable, 1 accessory bag, black							
		Colour, binding tape:	<input type="radio"/> Black	<input type="radio"/> Orange	<input type="radio"/> Silver	<input type="radio"/> Red	<input type="radio"/> Blue		
YNG030317	<input type="checkbox"/>	EXO PRO Backrest, synthetic fibre, padded, adj., breathable spacer fabric, 1 accessory bag, black						147	
		Colour, binding tape:	<input type="radio"/> Black	<input type="radio"/> Orange	<input type="radio"/> Silver	<input type="radio"/> Red	<input type="radio"/> Blue		
YNG030305	<input type="radio"/>	123 mm x 45 mm (3) (5)							
Headrest									
YNG030401	<input type="checkbox"/>	Medium	YNG030402	<input type="checkbox"/>	Large			204	
YNG030403	<input type="checkbox"/>	Stabiliser bar						146	

(1): starting with SW 32; reduces the seat depth by approx 1cm because of the padding

(2): not in combination with Safari wheel lock; Seat depth enlargement (5 cm); Standard backrest upholstery

							£										
ARMREST AND SIDE GUARDS																	
Armrest																	
YNG040101	<input type="checkbox"/>	Armrest height adjustable, short, screw-on	<i>(only with YNG040201, YNG040202 and YNG040211)</i>				91										
Side guards																	
YNG040201	<input type="checkbox"/>	Straight side guard aluminium with cloth protection					144										
YNG040202	<input type="checkbox"/>	Aluminium side guard for angle adjustable back at fixed angles with cloth protection					166										
YNG040203	<input type="checkbox"/>	Lightweight carbonfibre look side guard with integrated clothing guard	(1)				233										
YNG040211	<input type="checkbox"/>	Straight side guard aluminium with fender (Pair) - Tool height adj armrest possible					253										
YNG040212	<input type="checkbox"/>	Straight side guard aluminium with fender (Pair) for Safari wheel lock					253										
YNG040205	<input type="checkbox"/>	Plastic side guards detachable (Quickie style)	<i>(Quickie style)</i>				171										
Side guards options and accessories																	
YNG040210	<input type="radio"/>	Mud Guard	<i>(only with YNG040201 and YNG040202)</i>														
YNG040204	<input type="checkbox"/>	Fender, composite, screw-on, back	<i>(only with YNG040201 and YNG040202)</i>				70										
YNG040206	<input type="checkbox"/>	Height adjustable tray table, slide-on for SW 22-36cm (not 38 & 40cm)					145										
Therapy table flip-down for SW 26-40cm						203											
Attachment: YNG040207 <input type="checkbox"/> right-hand YNG040208 <input type="checkbox"/> left-hand																	
LEGREST & FOOTPLATES																	
Platform footrest, angle adjustable (only in position 3 - page 6/9)						<i>(LLL 30 - 45cm)</i>											
YNG050102	<input type="radio"/>	Composite board	<i>(Abduction frame SW 26 - 40; Std 30 - 40)</i>		<i>(depth adjustable)</i>												
YNG050103	<input type="checkbox"/>	Carbon board			<i>(depth adjustable)</i>	315											
YNG050115	<input type="checkbox"/>	Foot positioning plate					70										
YNG050106	<input type="radio"/>	Platform footrest "Youngster 3"	<i>(SW 38 & 40 with abduction is supplied w aluminium board)</i>														
YNG050107	<input type="checkbox"/>	Locking system for platform footrest					55										
YNG050108	<input type="checkbox"/>	Swing Away mechanism	<i>(not with Platform footrest, angle adjustable)</i>				143										
YNG050111	<input type="radio"/>	Divided platform "Youngster 3" - composite	<i>(not in SW 22cm)</i>														
Locking system for divided footrest																	
YNG050112	<input type="checkbox"/>	Right attachment					55										
YNG050113	<input type="checkbox"/>	Left attachment					55										
YNG050114	<input type="checkbox"/>	Lock for divided footrest (Right and left)					108										
YNG050101	<input type="radio"/>	Divided platform footrest Alu "Youngster3"	<i>(starts w abdu frame SW 26, Std SW 30cm)</i>														
Clamp for platform footrest "Youngster3"						<i>(not with Platform footrest, angle adjustable)</i>											
YNG050116		<input type="radio"/> Short (90mm)	YNG050117	<input checked="" type="radio"/> Long (121mm)	<i>(Std if nothing else selected)</i>												
Lower leg length (LLL)																	
						<i>(Attention: LLL has to be 2,5 cm lower than seat height front)</i>											
<input type="radio"/>	17	<input type="radio"/>	18	<input type="radio"/>	19	<input type="radio"/>	20	<input type="radio"/>	21	<input type="radio"/>	22	<input type="radio"/>	23	<input type="radio"/>	24		
<input type="radio"/>	15	<input type="radio"/>	25	<input type="radio"/>	26	<input type="radio"/>	27	<input type="radio"/>	28	<input type="radio"/>	29	<input type="radio"/>	30	<input type="radio"/>	31	<input type="radio"/>	32
<input type="radio"/>	33	<input type="radio"/>	34	<input type="radio"/>	35	<input type="radio"/>	36	<input type="radio"/>	37	<input type="radio"/>	38	<input type="radio"/>	39	<input type="radio"/>	40		
<input type="radio"/>	41	<input type="radio"/>	42	<input type="radio"/>	43	<input type="radio"/>	44	All measurements are in cm									
FRAME <i>(with smart and nice folding fixation and frame protection for the rear frame end and the axle plate)</i>																	
YNG010101	<input type="radio"/>	1 Standard folding frame (straight)	s				<i>(from SW 26 - 40 cm)</i>										
YNG010102	<input type="radio"/>	Abduction folding frame					<i>(from SW 22 - 40 cm)</i>										
Seat depth enlargement (5cm) <i>(all measurements are in cm)</i>																	
YNG010201	<input type="checkbox"/>	Seat depth enlargement (50 mm)	(2) (3) (4)														
1 Increases seat depth by 50 mm allowing better COG adjustment when used in combination with seat shells						<i>(only in combination with adjustable upholstery)</i>	275										

(1): not with combination cloth protection, armrest & plastic sideguard

(2): not with Safari wheel-lock

(3): only with YNG040201 & YNG040202

(4): not with mud guard

		£
Frame accessories		<i>(choose either tip assist or anti-tip tubes, not both)</i>
Tip assist (step tube)		
YNG010301	<input type="checkbox"/> Left	33
YNG010302	<input type="checkbox"/> Right	
YNG010305	<input type="checkbox"/> Pair	67
YNG010303	<input type="checkbox"/> Crutch holder with Velcro	71
<i>(only in combination with tip assist)</i>		
Anti-tip tubes, swing-away		
YNG010306	<input type="checkbox"/> Left	93
YNG010307	<input type="checkbox"/> Right	
YNG010308	<input type="checkbox"/> Pair	185
FORK		
<i>(compare with your choice on the first page)</i>		
YNG080101	<input checked="" type="radio"/> Fork Carbotecture® (4)	
YNG090093	<input type="checkbox"/> Fork for power add ons, 123x45 mm	67
<i>(only in black)</i>		
CASTORS		
<i>(compare with your choice on the first page)</i>		
Standard		
YNG080201	<input type="radio"/> Solid	(for 45 mm fork version only) (only for 4" & 5")
YNG080202	<input type="radio"/> Soft solid	(for 45 mm fork version only, not available with 111x45) (only for 5" & 6")
Light ups		
YNG080203	<input type="checkbox"/> Solid Light Ups	(not available for 6") 70
Castor with aluminium rim		
YNG080204	<input type="checkbox"/> Solid Aluminium	(only for 4" and 5") 81
YNG080205	<input type="checkbox"/> Soft roll	(for 45 mm fork version only) (only for 4" and 5") 81
REAR WHEELS		
YNG070101	<input type="radio"/> Straight spoked	(only 22")
YNG070102	<input type="radio"/> Cross spoked	(pair) (only 22" & 24")
YNG070103	<input type="radio"/> Design wheel	(pair) (only 24")
YNG070104	<input type="radio"/> Lightweight wheel	(2) (pair) (only 22" & 24")
YNG070105	<input type="checkbox"/> Proton wheel (super light weight)	(2) (pair) 526
YNG070111	<input type="checkbox"/> Drum brake wheels for attendant person	(pair) (only 22" & 24") 405
YNG070106	<input type="checkbox"/> Mountain Bike wheel	(only with 24", mountain bike tyres & aluminium rim, black coated) 335
YNG070107	<input type="checkbox"/> Additional mountain bike wheel pair	(only with 24" & mountain bike tyres) 453
One-arm drive with quick-release axle, one-arm brake not included (3)		
YNG070108	<input type="checkbox"/> Left	1082
YNG070109	<input type="checkbox"/> Right	
TYRES		
<i>(choose only one tyre type)</i>		
YNG070201	<input type="radio"/> Right Run	
YNG070202	<input type="radio"/> Solid tyres	(1) (only 22" & 24", not available with Safari wheel locks)
YNG070203	<input type="radio"/> Schwalbe One (Slight puncture resistance)	(only 24")
YNG070204	<input type="checkbox"/> 24" Two grip "down town"	(only 24") 95
YNG070205	<input type="checkbox"/> Marathon plus evolution	(puncture proof) (only 24") 83
HANDRIM		
<i>Not available for Mountain Bike or Spinergy wheels</i>		
YNG070301	<input type="radio"/> Aluminium silver anodized	(2)
YNG070302	<input type="radio"/> Aluminium silver powdercoated	(2) s
YNG070303	<input type="checkbox"/> Coloured aluminium pushrim. colour code:	(see page 5) 60
YNG070304	<input type="radio"/> Stainless steel	(only 22" & 24")
YNG070305	<input type="checkbox"/> Titanium	(only 22" & 24") 186
YNG070306	<input type="checkbox"/> Titanium clear powdercoated	(only 22" & 24") 186
YNG070307	<input type="checkbox"/> Supergrip	(only 22" & 24" and not available with lightweight wheels) 222
YNG070308	<input type="checkbox"/> Maxgrepp	(only 22" & 24") 222
Hand rim mounting	YNG070401 Standard = 17mm	YNG070402 <input type="radio"/> Wide = 27mm
	YNG070403 <input type="radio"/> Close = 7mm	(only with 24" stainless steel)
YNG070309	<input type="checkbox"/> Handrim cover	(only 22" & 24") 90
WHEEL CAMBER		
<i>(choose only one option)</i>		
YNG070501	<input type="radio"/> 0°	YNG070504 <input type="radio"/> 3°
YNG070502	<input type="radio"/> 1°	YNG070505 <input type="radio"/> 4°
Quick release axle		
YNG070506	<input type="radio"/> Std	
YNG070507	<input type="checkbox"/> Quad	105

- (1): not with Lightweight and Proton (2): not with handrim mounting wide for Lightweight and Proton wheels
(3): no colour coat, no camber adjustment, no drum brakes. Only with cross-spoked rear wheel available min. SW = 28
(4): Not available with 123 x 45 Fork Size

						£			
SPOKE GUARDS						(only available in 22 & 24")			
YNG070601	<input type="checkbox"/>	Transparent				122			
YNG070602	<input type="checkbox"/>	Rotation	YNG070613	<input type="checkbox"/>	Graphic		YNG070624	<input type="checkbox"/>	Bibbo
YNG070603	<input type="checkbox"/>	Fantasy	YNG070614	<input type="checkbox"/>	Galactica		YNG070625	<input type="checkbox"/>	Cheese
YNG070604	<input type="checkbox"/>	Princess	YNG070615	<input type="checkbox"/>	Dancing Bear		YNG070626	<input type="checkbox"/>	Jungle Fever
YNG070605	<input type="checkbox"/>	Happy Lions	YNG070616	<input type="checkbox"/>	Water world		YNG070627	<input type="checkbox"/>	Randolf
YNG070606	<input type="checkbox"/>	Monkeys	YNG070617	<input type="checkbox"/>	Pirates		YNG070628	<input type="checkbox"/>	Feather
YNG070607	<input type="checkbox"/>	Oriental	YNG070618	<input type="checkbox"/>	Racing		YNG070629	<input type="checkbox"/>	Dirt Race
YNG070608	<input type="checkbox"/>	Superhero	YNG070619	<input type="checkbox"/>	Graffiti		YNG070630	<input type="checkbox"/>	Chrome wheel
YNG070609	<input type="checkbox"/>	Hot Wheels	YNG070620	<input type="checkbox"/>	Basketball		YNG070631	<input type="checkbox"/>	Basketball 2
YNG070610	<input type="checkbox"/>	Pool	YNG070621	<input type="checkbox"/>	Flying water		YNG070632	<input type="checkbox"/>	Space
YNG070611	<input type="checkbox"/>	Silk	YNG070622	<input type="checkbox"/>	Abstract		YNG070633	<input type="checkbox"/>	Creative
YNG070612	<input type="checkbox"/>	Tiger	YNG070623	<input type="checkbox"/>	Zebra		(see Spoke Guard brochure)		
WHEEL LOCKS						(choose only one option)			
YNG060101	<input type="radio"/>	Standard wheel lock							
Knee lever wheel lock									
YNG060104	<input type="checkbox"/>	angled to the inside	YNG060102	<input type="checkbox"/>	angled to the outside	57			
YNG060105	<input type="radio"/>	Safari wheel lock (Wheel lock integrated into side guard)							
YNG060106	<input type="checkbox"/>	Attendant wheel lock with Safari wheel lock					(incl. YNG060105) 138		
YNG060107	<input type="checkbox"/>	Drum brake (for care person, quick-release axle, not available with attendant wheel lock)					(only 22" & 24") 405		
Wheel lock accessories									
YNG060201	<input type="checkbox"/>	Extension for knee lever wheel lock, slip-on, swing-away					(only on knee lever wheel lock) 42		
ACCESSORIES									
● Tool kit									
YNG090101	<input type="checkbox"/>	High pressure pump					80		
YNG090102	<input type="checkbox"/>	Air pump					11		
YNG090103	<input type="checkbox"/>	Back pack					59		
YNG090104	<input type="checkbox"/>	Net back bag					26		
YNG090105	<input type="checkbox"/>	Impact guard					62		
YNG090106	<input type="checkbox"/>	Bag caddy					(not with high mount platform footplates) 59		
YNG090107	<input type="checkbox"/>	Mobile phone bag					18		
COLOUR									
			Handrim £60	Hub/rim £171		Handrim £60	Hub/rim £171		
01 White RAL 9010	12	<input type="radio"/>	YNG090201	<input type="checkbox"/>	YNG090301	<input type="checkbox"/>	YNG090401		
02 Brilliant Silver		<input type="radio"/>	YNG090202	<input type="checkbox"/>	YNG090302	<input type="checkbox"/>	YNG090402		
03 Matt Silver		<input type="radio"/>	YNG090203	<input type="checkbox"/>	YNG090303	<input type="checkbox"/>	YNG090403		
04 Silver		<input type="radio"/>	YNG090204	<input type="checkbox"/>	YNG090304	<input type="checkbox"/>	YNG090404		
06 Sun Yellow		<input type="radio"/>	YNG090205	<input type="checkbox"/>	YNG090305	<input type="checkbox"/>	YNG090405		
07 Brilliant Lime	12	<input type="radio"/>	YNG090206	<input type="checkbox"/>	YNG090306	<input type="checkbox"/>	YNG090406		
08 Matt Lime		<input type="radio"/>	YNG090207	<input type="checkbox"/>	YNG090307	<input type="checkbox"/>	YNG090407		
14 Blue		<input type="radio"/>	YNG090212	<input type="checkbox"/>	YNG090312	<input type="checkbox"/>	YNG090412		
15 Brilliant Marine		<input type="radio"/>	YNG090213	<input type="checkbox"/>	YNG090313	<input type="checkbox"/>	YNG090413		
16 Matt Marine		<input type="radio"/>	YNG090214	<input type="checkbox"/>	YNG090314	<input type="checkbox"/>	YNG090414		
19 Brilliant Purple	12	<input type="radio"/>	YNG090216	<input type="checkbox"/>	YNG090316	<input type="checkbox"/>	YNG090416		
20 Matt Purple		<input type="radio"/>	YNG090217	<input type="checkbox"/>	YNG090317	<input type="checkbox"/>	YNG090417		
21 Red Ruby		<input type="radio"/>	YNG090218	<input type="checkbox"/>	YNG090318	<input type="checkbox"/>	YNG090418		
22 Brilliant Red		<input type="radio"/>	YNG090219	<input type="checkbox"/>	YNG090319	<input type="checkbox"/>	YNG090419		
23 Matt Red		<input type="radio"/>	YNG090220	<input type="checkbox"/>	YNG090320	<input type="checkbox"/>	YNG090420		
24 Tutti Frutti Orange		<input type="radio"/>	YNG090221	<input type="checkbox"/>	YNG090321	<input type="checkbox"/>	YNG090421		
26 Silver texture		<input type="radio"/>	YNG090223	<input type="checkbox"/>	YNG090323	<input type="checkbox"/>	YNG090423		
27 Graphite Metallic		<input type="radio"/>	YNG090224	<input type="checkbox"/>	YNG090324	<input type="checkbox"/>	YNG090424		
28 Platinum Metallic		<input type="radio"/>	YNG090225	<input type="checkbox"/>	YNG090325	<input type="checkbox"/>	YNG090425		
29 Black		<input type="radio"/>	YNG090226	<input type="checkbox"/>	YNG090326	<input type="checkbox"/>	YNG090426		
31 Matt black		<input type="radio"/>	YNG090228	<input type="checkbox"/>	YNG090328	<input type="checkbox"/>	YNG090428		
32 Signal white		<input type="radio"/>	YNG090229	<input type="checkbox"/>	YNG090329	<input type="checkbox"/>	YNG090429		
s Pink		<input type="radio"/>	YNG090230	<input type="checkbox"/>	YNG090330	<input type="checkbox"/>	YNG090430		
34 Dark Chocolate Metallic		<input type="radio"/>	YNG090233	<input type="checkbox"/>	YNG090333	<input type="checkbox"/>	YNG090433		
35 Sky Blue		<input type="radio"/>	YNG100127	<input type="checkbox"/>	YNG100227	<input type="checkbox"/>	YNG100327		
36 Cyan Metallic		<input type="radio"/>	YNG100128	<input type="checkbox"/>	YNG100228	<input type="checkbox"/>	YNG100328		
37 Mars Red		<input type="radio"/>	YNG100129	<input type="checkbox"/>	YNG100229	<input type="checkbox"/>	YNG100329		
39 Cappuccino		<input type="radio"/>	YNG100131	<input type="checkbox"/>	YNG100231	<input type="checkbox"/>	YNG100331		
40 Kiwi		<input type="radio"/>	YNG100132	<input type="checkbox"/>	YNG100232	<input type="checkbox"/>	YNG100332		
41 Flamingo Glitter		<input type="radio"/>	YNG100133	<input type="checkbox"/>	YNG100233	<input type="checkbox"/>	YNG100333		
42 Matt Anthracite		<input type="radio"/>	YNG100134	<input type="checkbox"/>	YNG100234	<input type="checkbox"/>	YNG100334		
43 Azure Blue		<input type="radio"/>	YNG100135	<input type="checkbox"/>	YNG100235	<input type="checkbox"/>	YNG100335		
Anodised colour package for fork and axle plate									
YNG090507 Silver Matt <input type="radio"/>						YNG090509 Black <input type="radio"/>			
Zippie Youngster 3 - Base Price						£1,997			
Option price						£			

Total Price	£
--------------------	---

Please follow measuring method:

The following method is recommended on the basis of extensive practical experience. Deviations are possible in individual instances

Seat width:

a) For the user:

Allow space of side guard to pass vertically between hip and side guard on each side (approx. 1 - 2 cm altogether).

b) On the wheelchair:

From outside frame tube to outside frame tube

Seat depth:

a) For the user:

When sitting upright: leave space for 2-3 fingers between front edge of seat upholstery and back of knee (approx. 3-6 cm). Care must be taken with adjustable upholstery.

b) On the wheelchair:

From back tube to front of seat upholstery.

Back height:

a) For the user:

Measured from the seat, including cushion, to **no more** than one finger (1 - 2 cm) below the lower shoulder blade.

Important! The back height depends on the degree of disability.

b) On the wheelchair:

From seat tube to upper edge of backrest upholstery.

Note: The user's ability to sit upright has a major influence on the back height and it can therefore differ considerably.

Lower leg length:

a) For the user:

With legs angled at right angles, from back of knee to bottom of shoe sole.

b) On the wheelchair:

From front of seat to top of footrest.

Remember: to include the cushion height

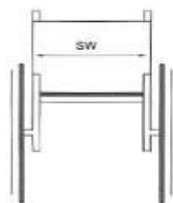

Overall width:

Overall width: 70 cm
Max overall height 97 cm
Max overall length 107 cm

Overall width with 24"

For 0° camber: SW+20
For camber: each degree is adding approx 1 cm
With drum brake +2 cm

Weights:

Minimum weight:
approx 8.5 kg

Folded size:

with rear wheels approx. 30 cm
without rear wheels approx. 24 cm
123 mm x 45 mm (3) (5)

NOTES:

Max seat height difference rear to front is 12 cm.

No negative seat angle is possible

Manufacturing tolerances of +/- 1 cm

123 mm x 45 mm (3) (5)

- Aluminium frame with integrated footrest
- Seat Depth 24 cm - 30 cm (short frame) 22" rear wheel
- Seat Depth 30 cm - 40 cm (long frame) 22" or 24" rear wheel
- Abduction frame if wanted
- Seat angle 4°
- Backrest as requested.
- Each degree of extra rear wheel camber would increase total chair width by 1 cm

- Side guard as requested
- Position of rear wheel
- 2 hole from back of the frame
- 3 position from the top of the frame
- Handrim in close position
- Camber from 0 to 4 degrees as requested
- Castors as requested
- Weight 7.7 kg without side guard + footrest

s

123 mm x 45 mm (3) (5)

(5) Not available with Carbotexture Fork

YOUNGSTER 3 Seat heights and lower leg length

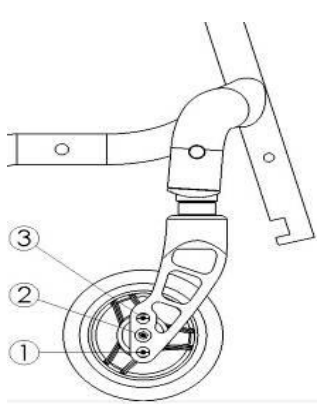
Seat height matrix - front seat height (in cm)					
	Fork Position	Castor size			
		4"	5"	6"	
	Fork (32/98 mm)	2	38	X	X
	Fork (32/98 mm)	1	40	41	X
	Fork (32/111 mm)	2	40	41	X
	Fork (32/111 mm)	1	41	42	X
	Fork (45/111 mm)	3	39	X	X
	Fork (45/111 mm)	2	40	41	X
	Fork (45/111 mm)	1	41	42	43
	Fork (45/123 mm)	3	40	41	X
Fork (45/123 mm)	2	41	42	43	
Fork (45/123 mm)	1	42	44	45	
Fork (45/138 mm)	3	42	43	43	
Fork (45/138 mm)	2	43	44	45	
Fork (45/138 mm)	1	44	45	46	
Fork (45/174 mm)	4	X	45	46	
Fork (45/174 mm)	3	44	46	47	
Fork (45/174 mm)	2	46	47	48	
Fork (45/174 mm)	1	47	48	50	

Details:
 * SH-details with 10 mm spacer between fork and frame - spacer could be mounted underneath the fork => reduced SH - 10 mm
 * without cushion
 * without seat angle (0°)
 * X = No Go

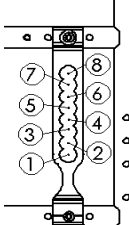
Seat height back (in cm) with rear wheels 20, 22 and 24"				
	Axle plate position	rear wheel size		
		20"	22"	24"
	8	32	35.5	X
	7	33	37	X
	6	35	38	41
	5	X	40	42.5
	4	X	41.5	43.5
	3	X	43	44.5
	2	X	44	45.5
	1	X	45.5	47

Details
 * measurements made with 1"-tyres
 * without cust 123 mm x 45 mm (3) (5)
 * without camber (0°)
 * without seat angle (0°)
 * X = No Go

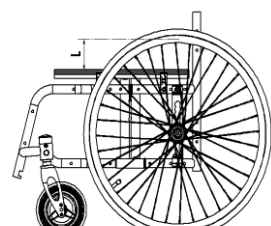
Distance between seat and handrim (outside tube)					
	Axle plate position	rear wheel size			
		20"	22"	24"	
	123 mm x 45 mm (8)	8	12.5	14	X
	123 mm x 45 mm (7)	7	11	13	X
	123 mm x 45 mm (6)	6	10	11.5	14.5
	123 mm x 45 mm (5)	5	X	10	13
	123 mm x 45 mm (4)	4	X	9	12
	123 mm x 45 mm (3)	3	X	8	10.5
	123 mm x 45 mm (2)	2	X	6.5	9.5
	123 mm x 45 mm (1)	1	X	5	8

Details
 * without cushion
 * without camber (0°)
 * X = No Go

Y3-LLL matrix; platform footrest, angle adjustable

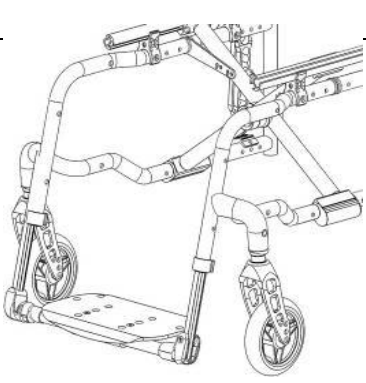
	Fork position	4"-Castor		5"-Castor		6"-Castor	
		30	34	X	X	X	X
(b) not available with Carbotextur	2	30	34			X	X
	1	30	34			X	X
Fork 111 mm	1	30	35	X	X	X	X
	3	30	34	X	X	X	X
	2	30	35	X	X	X	X
Fork 123 mm	1	30	36	X	X	X	X
	3	30	35	X	X	X	X
	2	30	36	X	X	X	X
Fork 138 mm	1	30	38	30	39	X	X
	3	30	36	X	X	X	X
	2	30	38	30	39	X	X
Fork 174 mm	1	30	39	30	40	X	X
	4	X	X	30	40	X	X
	3	30	40	30	41	30	34
	2	30	41	30	43	30	43
	1	30	42	30	44	30	45

Y3-platform footrest "Youngster 3 " style

Footplate position 1	Fork position	4"-Castor				5"-Castor				6"-Castor			
		Clamp short		Clamp long		Clamp short		Clamp long		Clamp short		Clamp long	
		min. LLL	max. LLL	min. LLL	max. LLL	min. LLL	max. LLL	min. LLL	max. LLL	min. LLL	max. LLL	min. LLL	max. LLL
Fork 98 mm	2	15	26	12	29	X	X	X	X	X	X	X	X
	1	15	26	12	29	15	26	12	29	X	X	X	X
Fork 111 mm	3	15	26	12	29	X	X	X	X	X	X	X	X
	2	15	26	12	29	15	26	12	29	X	X	X	X
Fork 123 mm	1	15	26	12	29	15	26	12	29	15	26	12	29
	3	15	26	12	29	15	26	12	29	15	26	X	X
Fork 138 mm	2	15	26	12	29	15	26	12	29	15	26	12	29
	1	15	26	12	29	15	26	12	29	15	26	12	29
Fork 174 mm	4	X	X	X	X	15	26	12	29	15	26	12	29
	3	15	26	12	29	15	26	12	29	15	26	12	29
	2	15	26	12	29	15	26	12	29	15	26	12	29
	1	15	26	12	29	15	26	12	29	15	26	12	29

Footplate position 2	Fork position	4"-Castor				5"-Castor				6"-Castor			
		Clamp short		Clamp long		Clamp short		Clamp long		Clamp short		Clamp long	
		min. LLL	max. LLL	min. LLL	max. LLL	min. LLL	max. LLL	min. LLL	max. LLL	min. LLL	max. LLL	min. LLL	max. LLL
Fork 98 mm	2	14	24	11	26	X	X	X	X	X	X	X	X
	1	14	24	11	26	14	24	11	26	X	X	X	X
Fork 111 mm	3	14	24	11	26	X	X	X	X	X	X	X	X
	2	14	24	11	26	14	24	11	26	X	X	X	X
Fork 123 mm	1	14	24	11	26	14	24	11	26	14	24	11	26
	3	14	24	11	26	14	24	11	26	14	24	X	X
Fork 138 mm	2	14	24	11	26	14	24	11	26	14	24	11	26
	1	14	24	11	26	14	24	11	26	14	24	11	26
Fork 174 mm	4	X	X	X	X	14	24	11	26	14	24	11	26
	3	14	24	11	26	14	24	11	26	14	24	11	26
	2	14	24	11	26	14	24	11	26	14	24	11	26
	1	14	24	11	26	14	24	11	26	14	24	11	26

123 mm x 45 mm (3) (5)

Footplate position 3	Fork position	4"-Castor				5"-Castor				6"-Castor			
		Clamp short		Clamp long		Clamp short		Clamp long		Clamp short		Clamp long	
		min. LLL	max. LLL	min. LLL	max. LLL	min. LLL	max. LLL	min. LLL	max. LLL	min. LLL	max. LLL	min. LLL	max. LLL
Fork 98 mm	2	25	35	22	35	X	X	X	X	X	X	X	X
	23 mm x 45 mm (3) (5)	25	36	22	36	25	35	22	38	X	X	X	X
Fork 111 mm	3	25	36	22	36	X	X	X	X	X	X	X	X
	2	25	37	22	37	25	35	22	38	X	X	X	X
Fork 123 mm	1	25	38	22	38	25	37	22	39	25	35	22	38
	3	25	37	22	35	25	35	22	38	X	X	X	X
Fork 138 mm	23 mm x 45 mm (3) (5)	25	38	22	36	25	37	22	40	25	35	22	38
	1	25	39	22	39	25	41	22	41	25	36	22	40
Fork 174 mm	3	25	36	22	39	25	36	22	40	25	35	22	38
	2	25	40	22	40	25	40	22	41	25	37	22	40
	1	25	41	22	42	25	41	22	42	25	39	22	42
Fork 174 mm	4	X	X	X	X	25	42	22	42	25	38	22	42
	3	25	42	22	42	25	43	22	43	25	41	22	44
	2	25	43	22	43	25	44	22	44	25	45	22	45
	1	25	44	22	44	25	46	22	46	25	47	22	47

ARMREST AND SIDEGUARDS

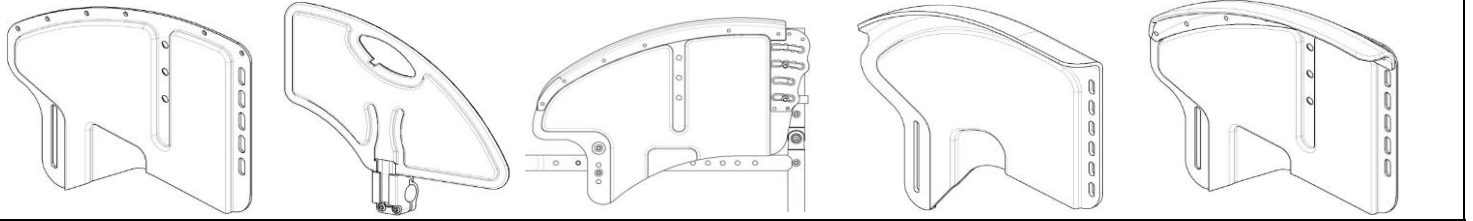

YNG040201

YNG040205

YNG040202

YNG040203

YNG040204

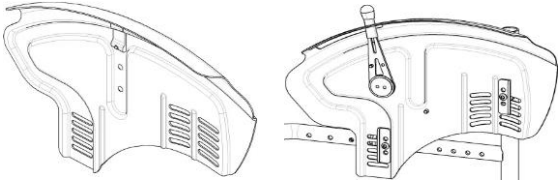

YNG040211

YNG040212

LEGREST & FOOTPLATES

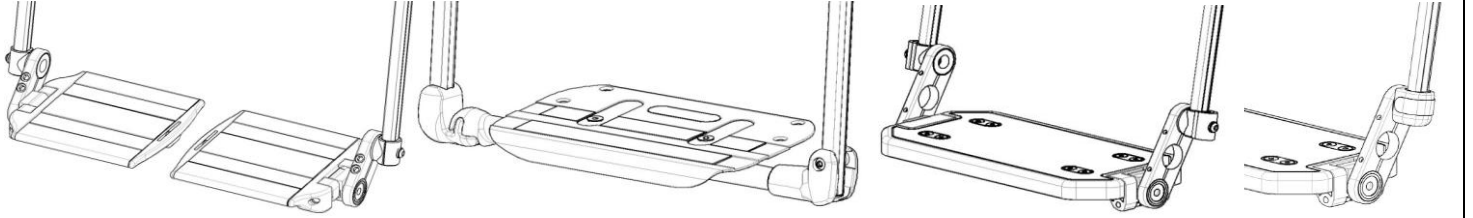

YNG050101

YNG050102 / YNG050103

YNG050106

YNG050108

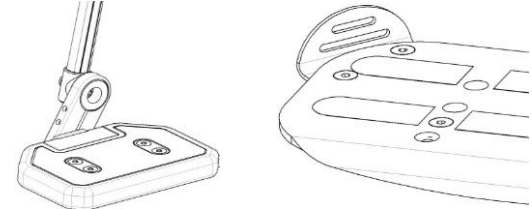

YNG050111

YNG050115

WHEEL LOCKS

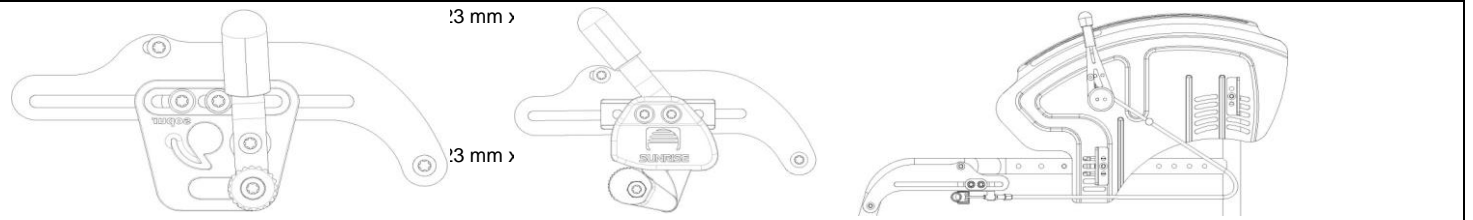

YNG060101

YNG060102

YNG060105

FRAME 123 mm x 45 mm (3) (5)

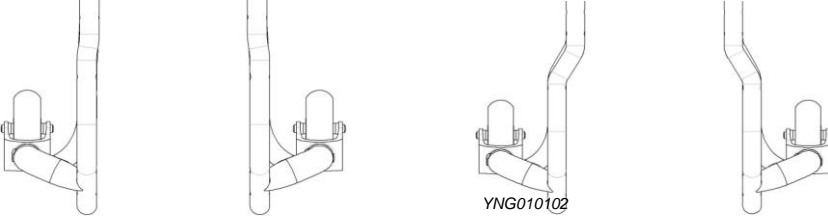

YNG010101

YNG010102
YNG010102

BACKREST

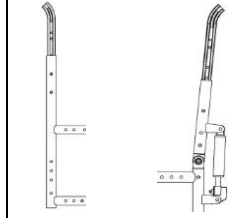

YNG030101

B4me

Seat depth growth

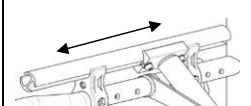

YNG010201
YNG010201

(5) Not available with Carbotexture Fork