

Tel: 01656 776222 Fax: 01656 776220

Email: ordersuk@invacare.com

Online spares available at: www.invacare.co.uk

January 2020

Customer Ref:	Account No :
Contact No:	Order No :
Delivery address :	Order Qty :
	Order Date :

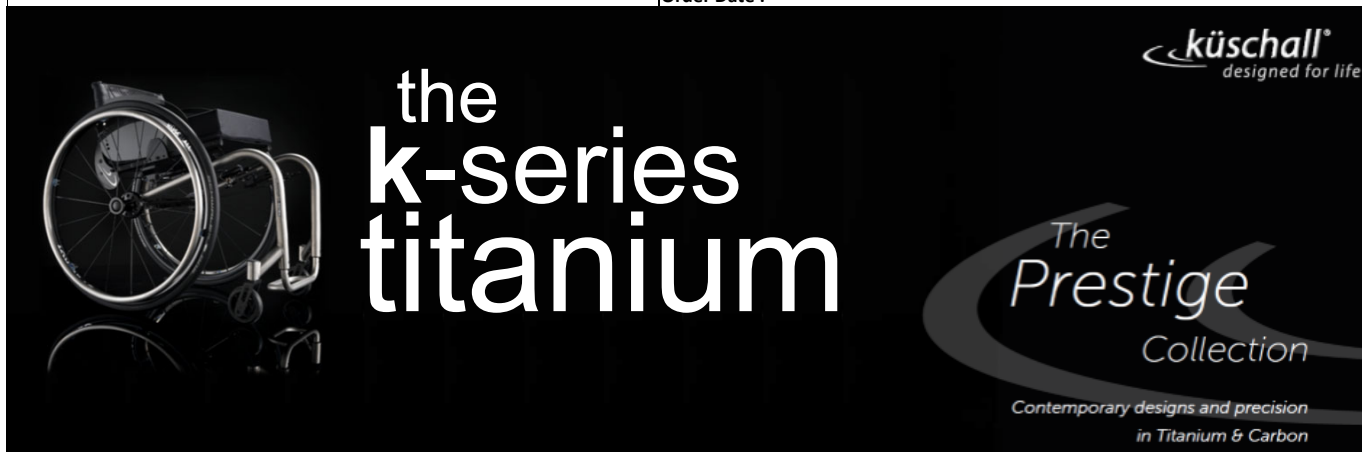

Standard Features



- Maximum user weight 120kg (19 stone)
- Active Rigid Wheelchair with Height Adjustable Aluminium Rigid Footrest
- Multiple adjustments, Front & Rear Seat Heights and Centre of Gravity
- Titanium Front Frame 75° or 90° Front Angle
- Standard Seat Upholstery
- 24" Self Propel Q/R Wheels with Grey Aluminium Handrims & Schwalbe Black & Grey Pneumatic Tyres
- Choice of 10 Seat Widths 320mm to 500mm
- Choice of 5 Seat Depths 350mm to 450mm
- Range of Front Seat Heights from 480mm to 520mm
- Range of Rear Seat Heights from 380mm to 490mm
- Aluminium Lockdown Folding, Angle & Height Adjustable Backrest
- Black Nylon Tension Adjustable Upholstery
- Without Push Handles, Carbon Clothesguards
- Aluminium Axle Tube with 3° Camber
- Black Comfort Front Castor, Standard Brake Lever Bent, Tool Kit

Standard Base Price £2,148

	X	Please make your selection with a cross in the box	◆ Standard feature	○ Free of Charge
--	---	--	--------------------	------------------

	Customer weight =	Kg
--	-------------------	----

Code	Description	Retail
DDZ0000	Kuschall® K-series Titanium Special Basic Model - PLEASE COMPLETE DETAILS AT THE END OF THE FORM	P.O.A.

TITANIUM FRAME		
DDA0287	K Series Titanium 75° Front Frame sand blast finish (No paint finish available) Footplate width = seat width less 120mm (V style front frame)	◆
DDA0292	K Series Titanium 90° Front Frame sand blast finish (No paint finish available) Footplate width = seat width less 120mm (V style front frame)	○

SEAT WIDTH (SB)

		Seat Width in mm										
		320mm	340mm	360mm	380mm	400mm	420mm	440mm	460mm	480mm	500mm	
		DDA0122	DDA0124	DDA0126	DDA0128	DDA0130	DDA0132	DDA0134	DDA0136	DDA0138	DDA0140	
Seat Depth in mm	350mm DDA0411	○	○	○	○	○	○	○	○	○	○	<p>Matrix backrests and seat cushions are not available with 320mm & 340mm seat widths, options DDA0122 & DDA0124</p> <p>Matrix MX2 backrest is not available with 480mm & 500mm seat widths, options DDA0138 & DDA0140</p> <p>Matrix Libra cushion is compatible with seat sizes 360-500mm wide and 400-450mm deep</p> <p>Matrix Vi cushion is compatible with seat sizes 360-500mm wide and 400-450mm deep</p> <p>Seat width 360mm on Matrix Libra & Vi cushions is only available with 400mm & 420mm seat depths</p> <p>Matrix Elite standard backrest height 360mm, option DDP0760 is not available with seat widths 480mm & 500mm</p>
	375mm DDA0414	○	○	○	○	○	○	○	○	○	○	
	400mm DDA0417	○	○	○	○	○	○	○	○	○	○	
	425mm DDA0420	○	○	○	○	○	○	○	○	○	○	
	450mm DDA0423	○	○	○	○	○	○	○	○	○	○	
Width between clothesguards = Seat Width + 15mm		Seat widths 440mm - 500mm and seat depth 450mm are not available with light seat upholstery, option DDA0615					Tension adjustable seat, option DDA0611 is not possible with seat width 320mm					
Footplate width = Seat width less 120mm							Titanium backrest, option DDA0731 is not possible with seat width 320mm					

Order No :

Customer Ref :

SEAT POSITION (SP) Note: Position 1 is the most active position

DDA0461	Position 1 = 140mm	Positions 1 & 2 are not compatible with seat depth 350mm, option DDA0411
DDA0462	Position 2 = 125mm	
DDA0463	Position 3 = 110mm	
DDA0464	Position 4 = 95mm	
DDA0465	Position 5 = 80mm	

The seat position can be moved forward and backward along the frame to achieve a more active or stable rear wheel position.

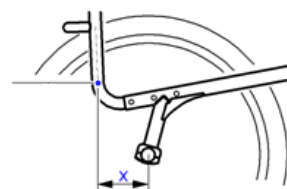

BACK HEIGHT (BH)

Back Height in mm							
270mm DDA0548	<input type="radio"/>	285mm DDA0580	<input type="radio"/>	300mm DDA0550	<input type="radio"/>	315mm DDA0503	<input type="radio"/>
330mm DDA0506	<input type="radio"/>	345mm DDA0509	<input type="radio"/>	360mm DDA0512	<input type="radio"/>	375mm DDA0514	<input type="radio"/>
390mm DDA0516	<input type="radio"/>	405mm DDA0518	<input type="radio"/>	420mm DDA0520	<input type="radio"/>	435mm DDA0522	<input type="radio"/>
450mm DDA0524	<input type="radio"/>	465mm DDA0526	<input type="radio"/>	480mm DDA0528	<input type="radio"/>		

Matrix backrests are available to order with the K-Series. Specific backposts supplied in aluminium, no back height selection required. The chair can be supplied with Matrix fitted or supplied without upholstery for retro fitting a backrest. If either is required, select option 0585. Refer to the Matrix section for backrest option details.

Back height 270mm is not available with Height adj rear set push handles, option DDA0703

In combination with tubular armrests, back height of between 270mm and 330mm are only possible with fixed push handles long or short, or without push handles

DDA0585 Backposts to suit Matrix or fixed backrests. Supplied without upholstery and backposts are 285mm high. Only available with backrests 0772 & 0773

FRONT SEAT-TO-FLOOR (FSTF)

Front Seat Height in mm							
480mm DDA0850	<input type="radio"/>	490mm DDA0851	<input type="radio"/>	500mm DDA0852	<input type="radio"/>	510mm DDA0853	<input type="radio"/>
						520mm DDA0854	<input type="radio"/>

REAR SEAT-TO-FLOOR (RSTF)

Rear Seat Height in mm							
390mm DDA0944	<input type="radio"/>	400mm DDA0945	<input type="radio"/>	410mm DDA0946	<input type="radio"/>	420mm DDA0947	<input type="radio"/>
430mm DDA0948	<input type="radio"/>	440mm DDA0949	<input type="radio"/>	450mm DDA0950	<input type="radio"/>	460mm DDA0951	<input type="radio"/>
470mm DDA0952	<input type="radio"/>	480mm DDA0953	<input type="radio"/>	490mm DDA0954	<input type="radio"/>		

Armrests DDA1416 & DDA1421 are not available with rear seat heights 380mm - 410mm

25" & 26" rear wheels are not available on rear seat height 390mm

26" rear wheels are not available on rear seat heights 400mm

LOWER LEG LENGTH (LLL)

290mm DDA1670	<input type="radio"/>	300mm DDA1671	<input type="radio"/>	310mm DDA1672	<input type="radio"/>	320mm DDA1673	<input type="radio"/>
330mm DDA1674	<input type="radio"/>	340mm DDA1675	<input type="radio"/>	350mm DDA1676	<input type="radio"/>	360mm DDA1677	<input type="radio"/>
370mm DDA1678	<input type="radio"/>	380mm DDA1679	<input type="radio"/>	390mm DDA1680	<input type="radio"/>	400mm DDA1681	<input type="radio"/>
410mm DDA1682	<input type="radio"/>	420mm DDA1683	<input type="radio"/>	430mm DDA1684	<input type="radio"/>	440mm DDA1685	<input type="radio"/>
450mm DDA1686	<input type="radio"/>	460mm DDA1687	<input type="radio"/>	470mm DDA1688	<input type="radio"/>	480mm DDA1689	<input type="radio"/>

On 75° Titanium frames: Maximum Lower leg length (LLL) must be front seat height minus 30mm

On 90° Titanium frames: Maximum Lower leg length (LLL) must be front seat height minus 40mm

Lower leg length must be measured taking away the cushion thickness







Lower leg lengths of less than 390mm in certain configurations could be delivered with an upmounted footplate.

Please refer to compatibility table at the end of this order form for configurations where the footplate will be standard mounted.

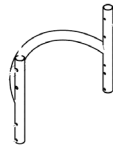
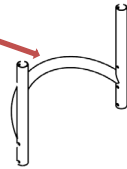
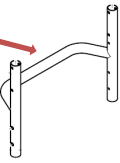
BACKREST

BACKREST MATERIAL

DDA0730	Aluminium		
DDA0731	Titanium	(NC: 0703,0772,0773)	£170

BACKREST TYPE			
STANDARD BACKREST FOR KUSCHALL UPHOLSTERY OPTIONS			
DDA0770	Standard backrest with rounded back bar, supplied with upholstery of choice. Not compatible with Matrx backrests (NC: 0733,0769)		◆
BACKREST FOR MATRX OR FIXED BACKRESTS. Select if ordering with Matrx or if retro fitting a backrest.			
DDA0772	Backrest to suit all Matrx backrests. Backpost height 285mm		○
DDA0773	Backrest to suit MX2 Matrx backrests. Backpost height 285mm	Not compatible with Matrx Elite Deep & Elite Standard backrests	○
<p>DDA0772 Backrest for Matrx MX2, Elite Deep & Elite Standard</p> <p>Push handles: If ordered with MX2 or without Matrx backrest, all push handles can be selected.</p> <p>Push handles: If ordered in combination with Matrx Elite Deep or Standard, only 0750 or 0733 are possible.</p> 			
<p>DDA0773 Backrest for Matrx MX2 only</p> <p>Push handles: If ordered without Matrx backrest, all push handles can be selected.</p> <p>Push handles: If ordered with MX2, only 0750 or 0733 are possible.</p> 			
BACK UPHOLSTERY			
DDA0726	Black nylon upholstery with tension adjustable back		◆
DDA0735	Aero, breathable spacer upholstery with tension adjustable back		£185
DDA0769	Without backrest upholstery, only select with options 0772 & 0773 Backrest to fit Matrx and fixed backrests		○
MATRX BACKREST (Hardware is supplied mounted to the backposts with the backrest supplied in the box with the wheelchair, extra leadtime applies) Please ensure the top of the Matrx backrest is not positioned higher than 480mm, which is the highest possible backrest setting on the K-Series.			
DDA0764	Matrx MX2 with Mini-set hardware Height of backrest 150mm	Compatible with seat widths 360mm - 460mm	£623
DDA0765	Matrx MX2 with Mini-set hardware Height of backrest 230mm		£623
DDA0766	Matrx MX2 with Mini-set hardware Height of backrest 305mm		£623
DDA0767	Matrx MX2 with Mini-set hardware Height of backrest 405mm		£623
 <p>MX2 backrest supplied with Mini-set hardware, spacer fabric cover with leatherette side panels.</p> <p>Maximum user weight 113kg/17.8 Stone</p>   <p>Shown mounted to backposts</p>			
DDA0756	Matrx Elite Deep with Easy-set mounting hardware Height of backrest 310mm	Compatible with seat widths 360mm - 500mm	£495
DDA0757	Matrx Elite Deep with Easy-set mounting hardware Height of backrest 410mm		£495
DDA0758	Matrx Elite Standard with Easy-set mounting Height of backrest 260mm		£447
DDA0759	Matrx Elite Standard with Easy-set mounting Height of backrest 310mm		£447
DDA0760	Matrx Elite Standard with Easy-set mounting Height of backrest 360mm	Compatible with seat widths 360mm - 460mm	£447
DDA0761	Matrx Elite Standard with Easy-set mounting Height of backrest 410mm	Compatible with seat widths 360mm - 500mm	£447
 <p>Matrx Elite Deep</p>  <p>Matrx Elite Standard</p>  <p>Matrx Elite Deep and Matrx Elite backrests are supplied with Easy-set hardware and spacer fabric cover</p> <p>Maximum user weight 136kg/21.4 Stone</p>			
DDA1111	Without Matrx backrest, select only if retro-fitting a fixed backrest		○
PUSH HANDLES			
DDA0750	Without push handles		◆
DDA0751	Fixed push handles short		£110
DDA0702	Fixed push handles long		£110
DDA0703	Height adjustable, rear set, maximum height of push handles is rear seat height + 600mm. Not compatible with Matrx backrests		£210
DDA0704	Foldable push handles		£164
DDA0733	Height adjustable integrated push handles, for without upholstery		£181
BACKREST ANGLE			
DDA0707	74° Angle from the seat		○
DDA0718	78° Angle from the seat		○
DDA0709	82° Angle from the seat		◆
DDA0719	86° Angle from the seat		○
DDA0711	90° Angle from the seat		○
SEAT UPHOLSTERY			
DDA0610	Standard black nylon with one 5cm wide central band (loop)		◆
DDA0615	Light mesh seat upholstery with one 5cm wide central band (loop)		£57
DDA0611	Tension adjustable seat with one 5cm central band (loop)		£37

Order No :

Customer Ref :

Kuschall K-SERIES Titanium
3 of 8Subject to Invacare's standard terms conditions.
Invacare reserve the right to alter product specification without prior notice.

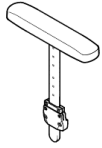
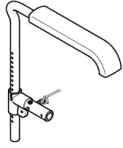
SEAT BAG/POUCH				
DDA0606	Seat Bag/Pouch (Mounted underneath seat, removable)		£61	
SEAT CUSHION				
DDA0600	Seat cushion 6cm foam with visco layer		£55	
DDA0662	Matrx Libra with Black Smooth cover Very High risk pressure & positioning cushion	Matrx Libra is compatible with seat sizes 360-500mm wide & 400-450mm deep	£323	
DDA0663	Matrx Vi with Black Meshtex cover High risk pressure & positioning cushion	Matrx Vi is compatible with seat sizes 360-500mm wide & 400-450mm deep	£299	
FOOTREST				
FOOTREST TYPE				
DDA1508	Foot tube rigid - Aluminium	(NC: 1570)	◆	
DDA1509	Foot tube rigid - Titanium (Not possible with upmounted footrest)	(NC: 1570)	£153	
DDA1570	Carbon footplate, angle adjustable	(NC: 1513)	£187	
FOOT TUBE COVER				
DDA1513	Foot tube cover select with foot tube rigid options only		£31	
CLOTHESGUARDS/MUDGUARDS				
DDA1401	Carbon clothes guards	(NC: 1408)	◆	
DDA1408	Carbon mud guards	(NC: 1416,1421)	£255	
ARMRESTS				
DDA1416	Armrest, height adjustable, short pad, non locking, without clothesguards		£136	
DDA1421	Armrest, height adjustable, long pad, non locking, without clothesguards		£136	
TUBULAR ARMREST: If tubular arms are required, in combination with back heights of 270-330mm only fixed or without push handles are available				
DDA1411	Tubular armrest. Height adjustable, removable, non-locking, swing-away & comfort padded		£199	
		DDA1416 DDA1421 Height adjustable		DDA1411 Tubular armrest
COLOUR-POWER-SET (CPS)				
CPS comprises of rear wheel rims, wheel hub and Q/R push buttons, castor forks, castor housing caps, seat module caps and backrest plate				
DDA0330	Colour-Power-Set techno-anthracite		£185	
DDA0334	Colour-Power-Set b-blue		£185	
DDA0329	Colour-Power-Set comet red		£185	
DDA0336	Colour-Power-Set arctic blue		£185	
DDA0337	Colour-Power-copper glaze		£185	
DDA0338	Colour-Power-chrome	Starec wheel rim supplied in black when Chrome CPS is selected	£185	
DDA0339	Colour-Power-champagne		£185	
DDA0340	Colour-Power-olive		£185	
FRONT WHEEL (5" Front castors are not available with a 90° front frame)				
DDA0800	75mm x 25mm (3" x 1") Supersport		○	
DDA0801	100mm x 30mm (4" x 1.2") Everyday wheel with black tyre		○	
DDA0803	100mm x 25mm (4" x 1") Starec techno-anthracite hub, black tyre		£69	
DDA0807	100mm x 25mm (4" x 1") Starec b-blue hub, black tyre		£69	
DDA0808	100mm x 25mm (4" x 1") Starec comet red hub, black tyre		£69	
DDA0830	100mm x 25mm (4" x 1") Starec copper glaze hub, black tyre		£69	
DDA0831	100mm x 25mm (4" x 1") Starec arctic blue hub, black tyre		£69	
DDA0809	100mm x 25mm (4" x 1") Starec black hub, black tyre		£69	
DDA0861	100mm x 25mm (4" x 1") Starec chrome hub, black tyre		£69	
DDA0825	100mm x 25mm (4" x 1") Starec champagne hub, black tyre		£69	
DDA0826	100mm x 25mm (4" x 1") Starec olive hub, black tyre		£69	
DDA0860	100mm x 30mm (4" x 1.2") Comfort wheel with black tyre		○	
DDA0796	100mm x 36mm (4" x 1.4") Softroll aluminium, black hub, black tyre		£77	
DDA0797	100mm x 36mm (4" x 1.4") Softroll aluminium, silver hub, black tyre		£77	
DDA0810	125mm x 30mm (5" x 1.2") Everyday wheel with black tyre		○	
DDA0863	125mm x 30mm (5" x 1.2") Comfort wheel with black tyre		◆	
DDA0813	125mm x 25mm (5" x 1") Starec techno-anthracite hub, black tyre		£69	
DDA0817	125mm x 25mm (5" x 1") Starec b-blue hub, black tyre		£69	
DDA0818	125mm x 25mm (5" x 1") Starec comet red hub, black tyre		£69	
DDA0833	125mm x 25mm (5" x 1") Starec copper glaze hub, black tyre		£69	
DDA0832	125mm x 25mm (5" x 1") Starec arctic blue hub, black tyre		£69	
DDA0819	125mm x 25mm (5" x 1") Starec black hub, black tyre		£69	
DDA0862	125mm x 25mm (5" x 1") Starec chrome hub, black tyre		£69	
DDA0827	125mm x 25mm (5" x 1") Starec champagne hub, black tyre		£69	
DDA0828	125mm x 25mm (5" x 1") Starec olive hub, black tyre		£69	
DDA0798	125mm x 36mm (5" x 1.4") Softroll aluminium, black hub, black tyre		£77	
DDA0799	125mm x 36mm (5" x 1.4") Softroll aluminium, silver hub, black tyre		£77	

Order No :

Customer Ref :

Kuschall K-SERIES Titanium
4 of 8

Subject to Invacare's standard terms conditions.
Invacare reserve the right to alter product specification without prior notice.

ONE ARM DRIVE SYSTEM (Complete wheel system supplied with pneumatic tyres and grey aluminium handrim and set at 0 degree camber)			
DDA1118		One-arm-drive right side (NC: 0276,0278,1200,1202,0909,0271,0272)	£452
DDA1119		One-arm-drive left side (NC: 0276,0278,1200,1202,0909,0271,0272)	£452
REAR WHEEL FIXATION			
DDA0250	<input checked="" type="checkbox"/>	Standard rear wheel position	◆
CAMBER AXLE TYPE			
10° Camber on Vario-Ax only locks with an Active Brake			
DDA0276		Vario-Ax, adjustable Camber 1/3/7/10° (NC: 0927,1302)	£237
DDA0277		Standard axle	◆
DDA0278		Carbon axle (reduces weight by 100g)	£175
CAMBER ANGLE			
DDA0270		0° camber	○
DDA0271		3° camber	◆
DDA0272		6° camber	○
QUAD RELEASE AXLE			
DDA0909		Quad quick release axle (NC: 0906,0912,0927)	£71
REAR WHEEL SIZE			
DDA0902		24" wheel (NC: 0918,0912)	◆
DDA0925		25" wheel (NC: 0906,0908,0913,0915,0927)	○
DDA0903		26" wheel (NC: 0906,0908,0912,0918,0913,0927,1303)	○
REAR WHEEL TYPE			
DDA0915		24", 26" Kuschall Starec with cross spokes (hub colourless and rim black or in CPS if selected) (NC: 1399)	◆
DDA0908		24" High performance wheel (Starec hub, spokes & rim black, hub only in CPS if selected) (NC: 1004,1006,1007,1399)	£210
DDA0918		25" High Performance wheel (Starec hub, spokes & rim black, hub only in CPS if selected) (NC: 1014,1002,1004,1006,1007,1102,1104,1106,1200,1202,1208,1399)	£302
DDA0913		24" Mountain Bike, fitted with specific 24" x 1.75" tyre Select either Aluminium or Supergrripp handrims only CPS not available (NC: 1014,1002,1004,1006,1011,1010,1007,1104,1106,1120,1202,1208,1399)	£205
DDA0906		24" Spineray LXX wheel (Black lightweight hub, 18 spokes black, No CPS) Coloured spokes are available via MyKuschall, please indicate requirements in the space provided at the end of the form. (NC: 1004,1006,1007,1200,1202,1208,1399)	£505
DDA0912		25" Spineray LXX wheel (hub, rim & spokes black) CPS not offered Coloured spokes are available via MyKuschall, please indicate requirements in the space provided at the end of the form. (NC: 1002,1004,1007,1200,1202,1208,1399)	£505
SWO0907		24" or 25" Spineray SPOX wheel (18 spokes in black, no CPS) Coloured spokes are available via MyKuschall, please indicate requirements in the space provided at the end of the form. (NC: 1004,1006,1007,1200,1202,1208,1399)	£402
SWO0909		24" or 25" Spineray LX wheel (12 spokes in black no CPS). Coloured spokes are available via MyKuschall, please indicate requirements in the space provided at the end of the form. (NC: 1004,1006,1007,1200,1202,1208,1399)	£608
DDA0927		24" Wheel with integrated hub brakes (Silver spokes with black hub and rim) CPS not available (NC: 1004,1006,1007)	£567
REAR WHEEL TYRE			
DDA1014		24", 25", 26" Schwalbe rightrun black & grey pneumatic tyre	◆
DDA1002		24" Profile 7 bar grey pneumatic tyre	○
DDA1004		24" Solid tyre, profil, grey	£55
DDA1006		24" Solid tyre black (KIK)	£72
DDA1011		24", 25" Schwalbe One V Guard, puncture resistant black pneumatic tyre	£80
DDA1010		24", 25", 26" Marathon Plus black pneumatic tyre with Smartguard 5mm layer of protective rubber infill (NC: 1020)	£82
DDA1007		24" Solid tyre light grey	£55

Order No :

Customer Ref :

Kuschall K-SERIES Titanium
5 of 8

Subject to Invacare's standard terms conditions.
Invacare reserve the right to alter product specification without prior notice.

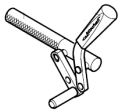
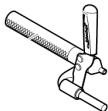
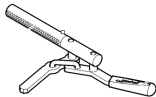
ANTI-FLAT PROTECTION			
DDA1020		Anti-flat tyre tube protection	£18
HANDRIM			
DDA1102		24", 26" Supergripp, long tab, 2 hole set at 3 cm distance	£185
DDA1104		24", 26" Steel polished, short tab, 1 hole set at 3 cm distance	£52
DDA1106		24" Titanium, short tab, 1 hole set at 3 cm distance	£159
DDA1121		24" Carbolife Gekko black coated (fully integrated rubber strip for extra grip) mounted at 3cm distance 25" Gekko handrims are available via Myküschall	£345
DDA1122		24" Carbolife Curve L black coated (unique shaped profile for low-effort grip) mounted at 3cm distance 25" Curve L handrims are available via Myküschall	£308
DDA1113		24", 25", 26" Light Alu grey, short tab, 1 hole set at 3 cm distance	◆
DDA1114		24", 25", 26" Light Alu grey, long tab, 2 hole set at 4 cm distance	○
DDA1117		24", 25", 26" Light Alu black, short tab, 1 hole set at 3 cm distance	£34
SPOKE GUARDS			
DDA1200		24", 26" Transparent	£104
DDA1202		24" Küsçall Black with white logo	£104
DDA1208		24" Transparent and white with Küsçall logo in black	£104
SAFETY			
DDA1300		Push to lock brake lever bent	◆
DDA1302		Performance brake (NC: 1310)	£64
DDA1303		Active/Scissor brake (NC: 1310)	£64
DDA1399		Without brake Can only be selected with DDA0927, wheel with hub brakes	○
<div style="display: flex; justify-content: space-around; align-items: flex-start;"> <div style="text-align: center;">  <p>DDA1300 Push to lock brake, lever bent</p> </div> <div style="text-align: center;">  <p>DDA1302 Performance brake</p> </div> <div style="text-align: center;">  <p>DDA1303 Scissor/active brake</p> </div> </div>			
SAFETY OPTIONS			
DDA1310		Extension lever for standard brake	£41
DDA1730		Seat belt	£61
ANTI TIPPER			
DDA1702		Anti-tipper tube right	£101
DDA1703		Anti-tipper tube left	£101
DDA1704		Anti-tipper tube both sides	£202
ACCESSORIES			
DDA1715		Air Pump	£11
DDA1712		Küsçall watch, right side, mounted in castor housing (NC: 1713)	£88
DDA1713		Küsçall watch, left side, mounted in castor housing	£88
DDA1717		Tool Kit	◆
DDA1739		Front frame protectors 1 pair (Not with upmounted footplate)	£31
DDA1734		Mountain bike wheels with bag are supplied with aluminium handrims only, includes quick release axles	£265
PRICE			
			Total Price £

Order No :

Customer Ref :

Kuschall K-SERIES Titanium
6 of 8

Subject to Invacare's standard terms conditions.
Invacare reserve the right to alter product specification without prior notice.

Non Conforming Items Guide	
DDA0702	Push handles fixed long
DDA0703	Height adjustable rear set push handles
DDA0704	Foldable push handles
DDA0733	Height adjustable integrated push handles
DDA0751	Push handles fixed short
DDA0772	Without backrest upholstery
DDA0906	24" Spinergy LX wheels
DDA0908	24" High Performance wheel
DDA0912	25" Spinergy LXX wheels
DDA0913	24" Mountain Bike wheel
DDA0915	24", 26" KÜSCHALL Starec
DDA0918	25" High Performance wheel
DDA1001	Light wheel 7 bar
DDA1002	Profile tyre 7 bar
DDA1004	Solid tyre, profil, grey
DDA1006	Solid tyre (KIK) black
DDA1007	Solid tyre Light, grey
DDA1010	Marathon Evolution tyre
DDA1011	Schwalbe One tyre
DDA1102	Supergripp handrim, 24", 26" dist. 3 cm
DDA1104	Steel polished handrim, 24", 26" dist. 3 cm
DDA1106	Titanium handrim, 24 "dist. 3 cm
DDA1120	Surge LT Handrim
DDA1200	Transparent Spokeguards
DDA1202	KÜSCHALL Spokeguards
DDA1208	24" Transparent and white with KÜSCHALL logo in black
DDA1302	Performance brake
DDA1303	Active brake
DDA1310	Extension lever for standard brake
DDA1399	Without brakes
DDA1408	Carbon mud guards
DDA1411	Tubular armrest, height adjustable, removable, swing-away, comfort padded
DDA1416	Siderest, height adjustable, short
DDA1421	Siderest height adjustable, long
DDA1570	Carbon footplate angle adjustable
DDA1713	KÜSCHALL watch left

TITANIUM K Series Frame Compatibility Table

The dimensions within this table give instances where the footplate will be standard mounted.
Any measurements outside of this table may result in the chair being delivered with an upmounted footplate.

	Frame Type	24" Rear Wheels			25" Rear Wheels			26" Rear Wheels		
		Front seat to floor (mm)	Knee to heel (mm)		Front seat to floor (mm)	Knee to heel (mm)		Front seat to floor (mm)	Knee to heel (mm)	
			Std footplate	Flip-Up footplate		Std footplate	Flip-Up footplate		Std footplate	Flip-Up footplate
Titanium	75° Titanium	480	370-450	N/A	490	370-460	N/A	500	370-470	N/A
		490	380-460	N/A	500	380-470	N/A	510	380-480	N/A
		500	390-470	N/A	510	390-480	N/A	520	390-490	N/A
	90° Titanium	480	370-440	N/A	490	370-450	N/A	500	370-460	N/A
		490	380-450	N/A	500	380-460	N/A	510	380-470	N/A
		500	390-460	N/A	510	390-470	N/A	520	390-480	N/A



My Küschall special build instructions

Please fill out the required measurements in the table if applicable and give full details of the special request in the space provided below.

Customised Measurements

Seat width (SW)	
Seat depth (SD)	
Back Height (BH)	
Front Seat To Floor (FSTF)	
Rear Seat To Floor (RSTF)	
Lower Leg Length (LLL)	
Backrest Angle (BA)	
Total Length/Total Width (TL/TW)	
Camber	
Client Weight	
Client Height	

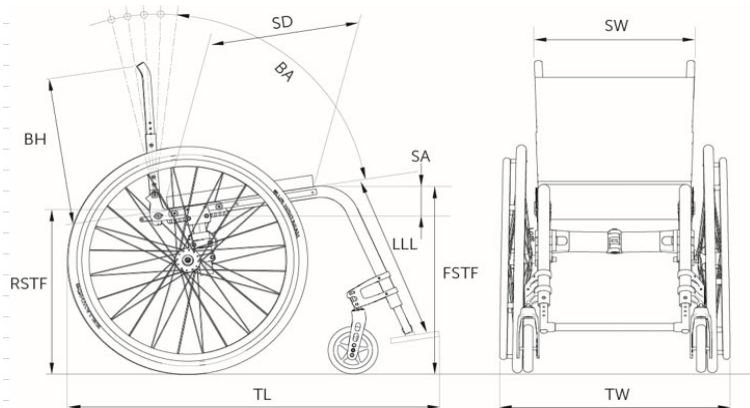

Order No :

Customer Ref :

Kuschall K-SERIES Titanium
8 of 8

Subject to Invacare's standard terms conditions.
Invacare reserve the right to alter product specification without prior notice.