



# Mygo Seat - Size 3

User Manual



**The Mygo Seat - Size 3 has been designed to offer a high level of postural positioning while enabling function and mobility. This manual shows how you can quickly, easily and safely make use of all the functions. The instructions on safety and maintenance will ensure that you will enjoy the use of this product for a long time.**

## **CONTENTS**

01	Intended use	p.4
02	Certification	p.4
03	Warnings and Cautions	p.5
04	Terms of warranty	p.6
05	Product history record	p.6
06	Product training record	p.7
07	Safety information	p.7
08	Precautions and Contraindications	p.9
09	How to unpack and assemble the seat	p.10
10	Fitting the cushions	p.21
11	Clinical setup for postural management	p.26
12	Frequent adjustments for daily use	p.38
13	Cleaning & care information	p.48
14	Daily product inspection	p.49
15	Annual product inspection	p.49
16	Reissuing Leckey products	p.51
17	Product servicing	p.52
18	Technical information	p.53
19	Table of Symbols	p.56

---

## **SECTION 01: INTENDED USE**

### **Intended use**

Leckey's seating systems are intended to support children and young adults who have mild to complex postural needs that affect the ability to sit without additional support.

### **Indications for use**

Mygo Seat – Size 3 is a modular seating system designed to cater for the needs of children with a variety of disabilities which effect their ability to sit independently without external postural supports. It is indicated for use primarily within a home, indoor school environment or outdoors, if used on a mobility base. Mygo Seat – Size 3 has an approximate age range of 10-16 years, with a maximum user weight of 70kgs (154lbs). The configurable postural support offered by Mygo Seat – Size 3 is indicated for use for children with moderate to complex postural needs (GMFCS IV-V).

## **SECTION 02: CERTIFICATION**

Mygo Seat – Size 3 is classified as a Class I Medical Device under EU and UK regulations. As the manufacturer, James Leckey Design Limited, declares that this product conforms to the Medical Device Regulation (2017/745), UK Medical Device Regulations 2002, Medical Device Directive (93/42 EEC) and EN 12182:2012 Assistive products for persons with disability, general requirements and test methods.

**Notice to the user and/or patient:  
Any serious incident that has occurred in relation to the device should be reported to the manufacturer and the competent authority of the Member State in which the user and/or patient is established.**

### **NOTE:**

**General user advice.**

**Not following these instructions may result in physical injury, damage to the product or damage to the environment!**

## **SECTION 03: WARNINGS AND CAUTIONS**

### **Warning Toppling Hazard:**

- Using the seat in extremes of its range of positions will reduce its stability. Only use the seat at maximum height and/or maximum seat recline when on level ground (less than 2-degree slope).
- When using the seat on slopes/ ramps (up to 10 degrees) ensure that the seat back is in the upright position and the seat height is below half height.

### **Warning Finger Trap Hazard:**

- Take care that the fingers of the operator or children on the floor do not get trapped in the powered seat raising and lowering mechanism.

### **Warning Occupant Security:**

- Ensure that all of the occupant harnesses and especially the pelvic belts are fastened and adjusted to hold the occupant securely in place before moving the seat or leaving the vicinity of the static seat.

### **Caution Finger Pinch Hazard:**

- Take care when assembling or adjusting the position of the seat components that your fingers do not get pinched when positioning seat components and tightening mountings.

### **Caution Daily Checks:**

- The seat is to be checked daily before use to ensure that all harnesses and seating elements are securely attached to the seat and chassis. Also check the battery charging cable for signs of damage before use. See section 'Daily product inspection' for details of checks.

### **Caution Trip Hazard with Powered Chassis:**

- Ensure that battery charging connection for the powered chassis is removed from the seat before moving the seat.

### **Caution Cleaning:**

- Clean the seat regularly to prevent the build-up of dirt on the seating elements and the chassis. Accumulated dirt can prematurely wear the seat cushions and encourage corrosion on the chassis. Only use non-abrasive household cleaners and moist cloths, do not use running water on the upholstery whilst it is still attached to the seat. See section 'Cleaning & care information'.

### **Caution Cleaning Power Washer/ Hose:**

- Do not use hoses or power washers on the frame components, the electric seat lift system is not sealed against running water and may be damaged by water ingress. See section 'Cleaning & care information'.

### **Caution Servicing/Repair of electronic components**

- There are no user-serviceable components in the electric power seat lifting assembly. Servicing and repairs are only to be carried out by Leckey-authorized personnel.

### **Caution Disposal**

- Only dispose of the seat in a community waste disposal site and ensure that the electrical components are removed for separate disposal.

### **Caution Bringing into Use**

- When bringing the seat into use from storage, allow it to acclimatise to ambient temperature for 2 hours first. Wipe off any moisture that has condensed on the product.

## **SECTION 04: TERMS OF WARRANTY**

The warranty applies only when the product is used according to the specified conditions and for the intended purposes, following all manufacturers' recommendations (also see general terms of sales, delivery and payment). A three year warranty is provided on all Leckey manufactured products and components.

## **SECTION 05: PRODUCT HISTORY RECORD**

Your Leckey product is classified as a Class 1 Medical device and as such should only be prescribed, set up or reissued for use by a technically competent person who has been trained in the use of this product. Leckey recommend that a written record is maintained to provide details of all setups, reissue inspections and annual inspections of this product.

## **SECTION 06: PRODUCT TRAINING RECORD**

### **(Parents, Teachers & Carers)**

Your Leckey product is a prescribed Class 1 Medical Device and as such Leckey recommend that parents, teachers and carers using the equipment should be made aware of the following sections of this user manual by a technically competent person.

Section 7: Safety Information

Section 12: Frequent Adjustments for Daily Use

Section 13: Cleaning & Care Information

Section 14: Daily Product Inspection

Leckey recommend that a written record is maintained of all those who have been trained in the correct use of this product.

## **SECTION 07: SAFETY INFORMATION**

1. Always read instructions fully before use.
2. To improve safety we recommend that users should not be left unattended at any time whilst using Leckey equipment.
3. Only use Leckey approved components with your product. Never modify the product in any way. Failure to follow instructions may put the user or carer at risk and will invalidate the warranty on the product.
4. If in any doubt to the continued safe use of your Leckey product or if any parts should fail, please cease using the product and contact our Customer Care Team or your local dealer as soon as possible.
5. Carry out all positional adjustments and ensure that they are securely fastened before you put the user into the product. Some adjustments may require the use of a tool which is provided with each product. Keep all tools out of reach of children.
6. When putting the user into a seating system, both for positional and safety reasons, always secure the pelvic harness first.
7. When the product is stationary ensure that all castors are locked and facing away from the base, as this will improve product stability. This is especially important when the tilt in space or back recline facility is in use.
8. When the seat is in use on a Hi-low chassis please ensure that the height adjustment pedal and tilt-in-space lever are locked off and cannot be adjusted accidentally.

by other children.

9. When the Leckey seats are used on the Hi-low chassis we do not recommend that users are moved over uneven surfaces when in the equipment. All due care and attention should be taken if transporting in and out of the seat.
10. Never leave the product on a sloping surface, greater than 5 degrees. Always remember to lock all the castors.
11. Only use the push handle to steer and move the seat from one area to another. Never use the tray or headrest for this purpose.
12. The product contains components which could present a choking hazard to small children. Always check that locking knobs and bolts within the child's reach are tightened and secure at all times.
13. Leckey products comply with fire safety regulations in accordance with EN12182. However the product contains plastic components and therefore should be kept away from all direct sources of heat including naked flames, cigarettes and gas heaters.
14. Do not place objects hotter than 40°C on the tray.
15. Clean the product regularly. Do not use abrasive cleaners.

Carry out maintenance checks on a regular basis to ensure your product is in good working condition.

16. The product is designed for indoor use and when not in use should be stored in a dry place that is not subjected to extremes of temperature. The safe operating temperature range of the product is +5 to +40 deg Celsius.
17. Always check the plastic hand knobs on the push handle are tightened securely before you move the seat unit.
18. Before using the seat always check that the interface handle on the seat unit is fully engaged with the chassis. If the handle is not engaged properly the seat unit may come loose and could cause serious injury to the child or carer
19. Please be aware of the gap on the underside of the Tray where a child could insert their finger between the metal bracket and the base of the plastic tray.

### **Crash Test**

The Mygo Seat - Size 3 Shas been crash tested and passed for use in vehicles. It has been tested in its complete configuration on a surrogate base with a Leckey head support attached.

If the Mygo Seat - Size 3 is being used in a vehicle the following points must



be adhered to:

The Mygo Seat - Size 3 must be positioned forward facing and used with an Unwin Restraint System and a head support which should be suitably positioned at all times during transportation. The head support is available as an optional accessory with the Mygo Seat - Size 3.

The Mygo Seat - Size 3 is crash tested and meets the requirements of ISO16840 part 4. For further details please contact our Customer Care Team.



### **Important**

These crash test details refer to the Mygo Seat - Size 3 and interface plate only. If you are using the Mygo Seat - Size 3 on a wheelchair base, please refer to the wheelchair manufacturer's handbook for crash test details.

### **Medical Device Combinations**

It may be possible to combine the Mygo Seat - Size 3 with one or more other Medical Device or other product. Information on which combinations are possible can be found at [leckey.com](http://leckey.com). All combinations listed have been validated to meet the General Safety and Performance Requirements, section 14.1 of the Medical Device Regulation 2017/745.

Guidance on the combination, such as mounting, can be found at [leckey.com](http://leckey.com)

## **SECTION 08: PRECAUTIONS AND CONTRAINDICATIONS**

### **Precautions**

- Fixed spinal deformities such as scoliosis or kyphosis
- Severe muscle contractures
- Severe muscular or skeletal asymmetry including hip dislocation
- Progressive and muscle wasting conditions
- High risk or recent history of bone fractures
- High risk of pressure related injury or open sores
- Strong, uncontrolled movement patterns
- Poorly controlled seizure activity
- Children dependent on the use of percutaneous endoscopic gastrostomy
- Medical instability including compromised respiratory or cardiovascular function

- Dependant on 3rd party life-sustaining apparatus such as oxygen tanks
- Significant learning disabilities and/or behavioural issues.

### **Contraindications**

There are no contraindications associated with the Leckey Seating product family.

All precautions and contraindications are taken at the discretion of the prescribing clinician. Leckey recommends a trained and experienced clinician to be present during the initial assessment, set up, configurations and re-issues in order to minimise risk.

## **SECTION 09: HOW TO UNPACK AND ASSEMBLE**

### **Check parts**

Congratulations on purchasing your Mygo Seat - Size 3. All of the parts will be contained in polythene bags with each one clearly labelled. Carefully remove them from the boxes and check all the parts you have ordered.

**Safety First**  
Keep polythene bags away from children.

Some of the accessories will need to be assembled before you attach the seat to the base you have purchased. If you are fitting the seat to a mobility base please ensure you fit the interface plate to the mobility base first. Instructions on how to attach the interface to specific bases will be provided with the interface plate. Once you have checked all the components you are then ready to assemble the Mygo Seat - Size 3 and attach it to its base.

## **9.1 SETTING THE BACKREST**

The backrest will be folded down for shipping. Raise it into the vertical position and, while doing so, slide the inner tube into the receiving outer tube. Secure the backrest in an upright position and tighten the socket cap. Check that it is secure and does not move when pressure is applied. If the user thrusts forward or backwards they could cause injury to themselves or their carers.





Always make sure the backrest is attached securely.

Use caution when inserting inner tube as there could be possible finger nip.



Always make sure the foot plate is attached firmly.

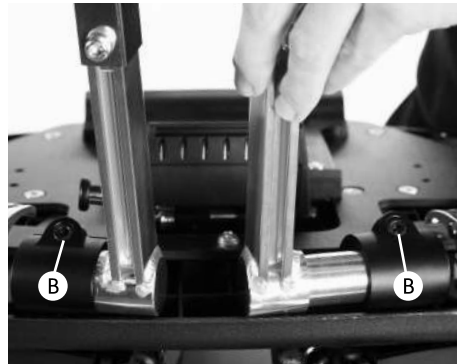
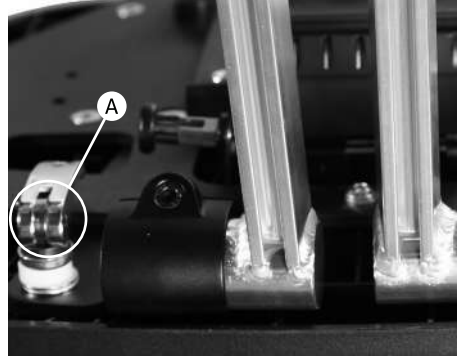

## 9.2 ATTACHING THE FOOTREST

(if ordered)

If using the Leckey footrests, remove the seat from the chassis and set the seating system upside down on a work surface. Open up the angle of the leg supports by releasing the two locking levers **A**, shown, and set to the maximum width. Open the socket caps **B** and slide in the calf supports. Set to the desired position, with the footplates facing forward and retighten the socket cap bolts with the multi-tool.

## 9.3 ATTACHING THE SEAT TO THE HI-LOW CHASSIS

Adjust the height of the chassis to its maximum to reduce risk of back strain while attaching the seat unit. Refer to Section 12 on how to adjust the height of the chassis you have purchased.

First release the safety locking pin at the front of the seat. To do this pull the pin out and rotate through 90 degrees. Carefully lift the seat and place it into the chassis. At the rear of the underside of the seat you will see a receiving channel. Place this securely over the tube towards the back of the chassis. Pull the handle at the front of the seat unit up and then pivot the seat forward and down. Once the front of the seat is lowered fully, release the handle and push it forward to ensure it has fully engaged on the front tube. Rotate the safety locking pin so it engages in front of the handle. If it hits the handle then the seat is not inserted properly. Remove and repeat process outlined above.



Always check the handle and locking pin are fully engaged before you place the child in the seating system. If the handle is not engaged properly the seat unit can come loose and could cause serious injury to the child or carer.



## 9.4 ATTACHING THE PUSH HANDLE

The push handle is attached to the Hi-low chassis by inserting the two lower stems into the receiving tubes as shown. The push handle has safety poppers **A**, which need to be pressed in when inserting the lower stems. Push the stems in until the poppers protrude from the other end of the receiving tubes. Secure the handle in place by tightening the locking knobs **B**.





Check these regularly to make sure the knobs are tight, particularly if you are moving the product unit along corridors that may have uneven or sloping surfaces.

receiving bracket and lock the vertical stem in position using the ratchet handle.

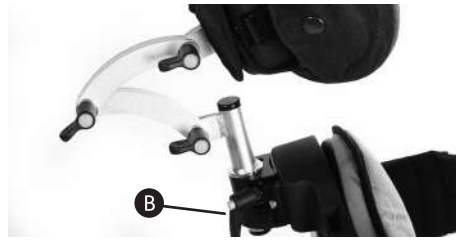
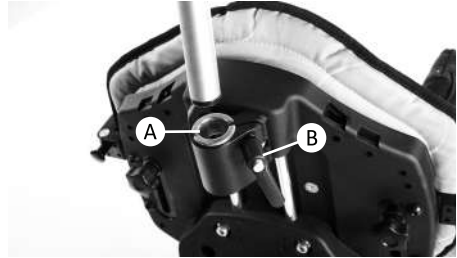
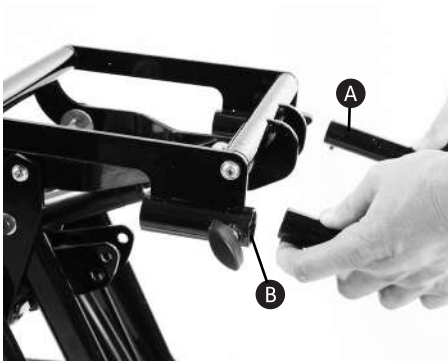

## 9.5 ATTACHING THE HEADREST

To attach the head support slide the stem into the reducing sleeve **A** and receiving bracket. Ensure the slot in the reducing sleeve is aligned with the slot in the receiving bracket. Set to the desired position and secure using the hand lever **B**. The Mygo Seat - Size 3 has been designed to interface with Whitmyer head supports. The Whitmyer Lynx head support **C** is attached in the same way as the Leckey headrest. To attach Whitmyer Pro-Series head supports remove the spacer collar **D** from the



## 9.6 ATTACHING THE LATERAL SUPPORTS

While holding the components together, remove the plastic knob and washer. Align the plastic angle adjuster mouldings and lateral bracket with the slot in the backrest and refit the washer and plastic knob.



## 9.7 ATTACHING THE KNEEPADS

Attach the kneepads with the snap fasteners to the knee guides on the sides of the upper legs supports.

## 9.8 INSERTING ATTACHMENT BOLTS ON SANDALS

Insert the required attachment bolt **A** along with the retention plate **B**. Place a rubber lid **C** on both the top and bottom of the sandal. Fasten using the four screws **D** provided. To remove or replace the attachment bolt, reverse this process.

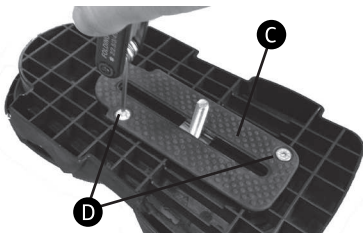
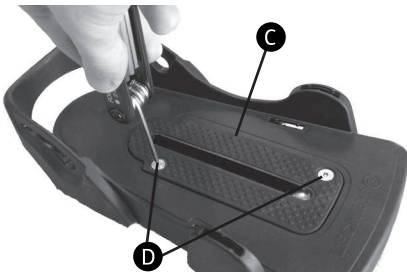
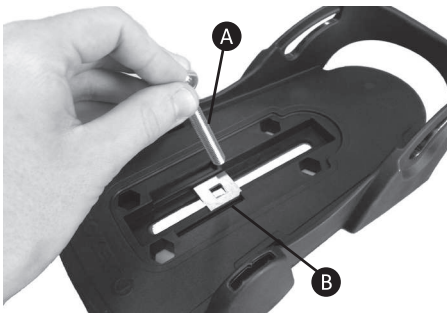

## 9.9 ATTACHING THE SANDALS

Place the sandal so that the attachment bolt goes through the slot in the footplate. To secure, on the underside of the footplate place the rubber washer **A**, followed by the metal washer **B** and then the knob **C** onto the attachment bolt. To position the sandals simply loosen the knob **C** under the footplate, select the position you require and re-fasten the knob.

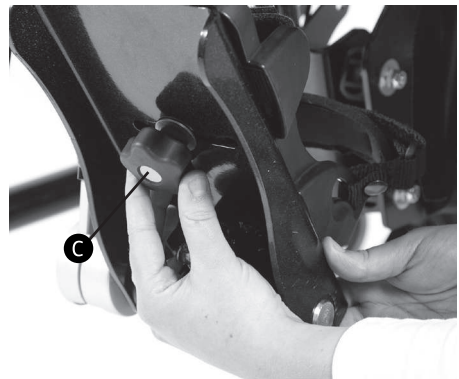
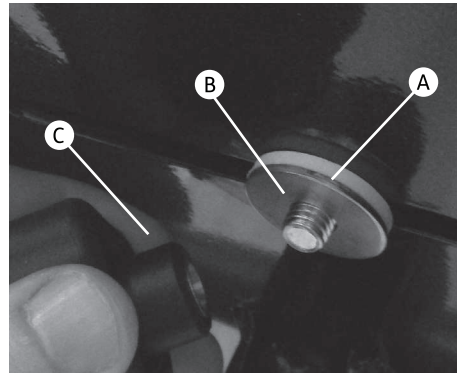

## 9.10 ATTACHING THE ANKLE HUGGERS

Slide the webbing through the slot in the sandal. Loop the webbing back up and through the bottom of the triglide. Then pass the webbing through the top of the triglide. Finally, to lock the webbing in place, pass it through the bottom of the triglide again.

Trim strap to required length.





## 9.11 ATTACHING THE ARMRESTS

Open the receiving bracket by loosening the ratchet handle **A** and insert the armrest. Ensure that the popper **B** has locked securely. Retighten the ratchet handle.

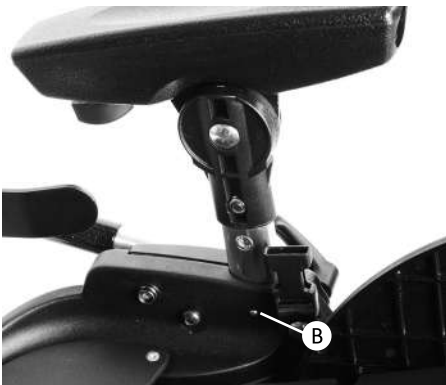

## 9.12 ATTACHING THE TRAY

The tray is attached to the seat by inserting the tray tubes through the centre of the armrest. Once the tray is located in the position the knob **A** should be tightened securely.

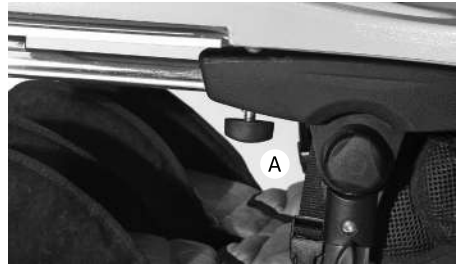

## 9.13 ATTACHING THE GRAB RAIL

To attach the grab rail, insert the receiving brackets **A** in the tray slot and secure with the plastic knob **B**. Repeat on the other side and then slide the tubes into the receiving brackets **A** and tighten the plastic knob **C**.



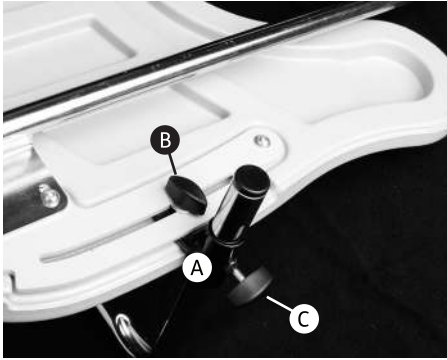

## 9.14 ATTACHING THE HIP LATERALS

Hip laterals are used with the Pelvic Cradle. First, remove the Pelvic Harness brackets if required, by removing the screw and flange nut **A**. Lift the piece of polypropylene on the front of the sacral support. Place the hip lateral brackets into the slots and attach using the flange nuts **B** and screws **C** provided. The flange nuts should go on the front side of the sacral support.



## 9.15 RETROFITTING THE DYNAMIC BACKREST

To replace the standard static backrest with the dynamic backrest first of all you will need to remove the screw **C** at the top of the standard backrest assembly. To do this loosen the nut **A** using the Leckey tool and a 10mm spanner and remove the screw and washers **B**.

Again using the Leckey tool and the 10mm spanner, loosen the nut **A** at the bottom of the standard backrest assembly then remove screw **C** saddle washers **D** and standard washers **B**.

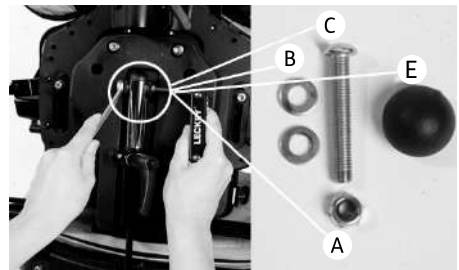
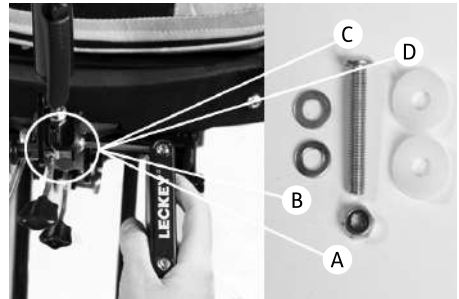

To fit the dynamic backrest, insert the strut into the bottom bracket as shown. Use the provided screw **C**, nut **A**, saddle washers **D** and standard washers **B** to secure in place. Please ensure that the screw thread protrudes through the nut **A**.

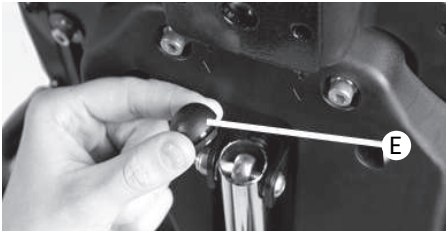
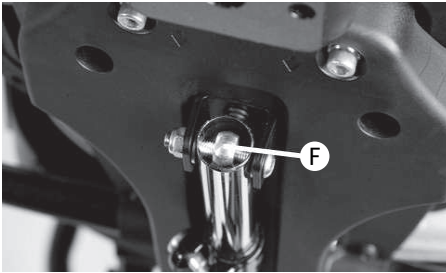

Now raise the dynamic strut and insert into the top bracket as shown. Using the provided screw **C**, nut **A** and washers **B**, secure the new dynamic backrest in place as shown.

Ensure that the bolt goes through the centre of the assembly as shown **F**. Finally fit the domed cap **E**.



Use caution when assembling and fitting the dynamic backrest as there is a minor risk of finger nipping.

## 9.16 ATTACHING THE OBLIQUITY PADS

To attach the obliquity pads first remove the base cushion. Set the obliquity pad panel in place with the holes on the tab over the snap fastener. Insert foam as required and refit the base cushion.

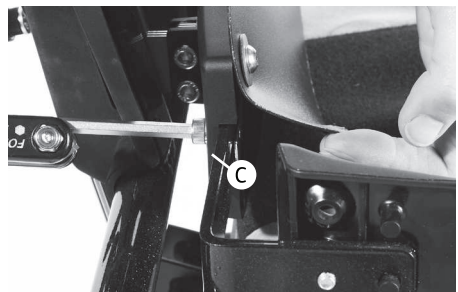
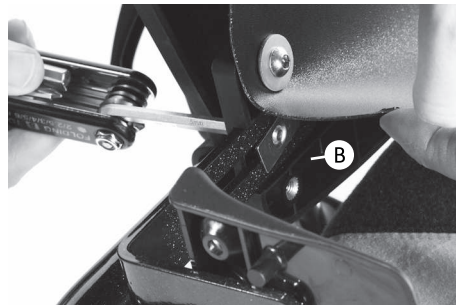

## 9.17 INTERFACES FOR WHEELCHAIR AND PUSHCHAIR BASES

The set up and attachment of the Mygo seat Size 3 to any mobility base should be completed by a technically competent person who is familiar with the set up of the mobility base.

**Interface “A” attachment to 16” wide mobility base.**

The universal interface has been designed to enable the Mygo Seat Size 3 to be attached to any standard 16” (405mm) wide mobility base that has been constructed from 1” (25.4mm) side tubing.

Please refer to specific assembly instructions supplied with your interface for correct positioning on your base.



The Interface plate should be fitted by a qualified technician who is technically competent in the set up of the mobility base. The position of push handles, leg hangers and armrests on the mobility base may need to be adjusted depending on the size and weight of the child to ensure the stability of the seat.



Always refer to the mobility base manufacturer's guide lines for correct set up, paying particular attention to product centre of gravity and stability.

Users should not be left unattended at any time whilst using Leckey equipment.



## SECTION 10: FITTING THE CUSHIONS

We suggest the cushions are fitted in the following order:

1. Femoral cushions (if applicable)
2. Seat base cushion
3. Sacral cushion
4. Pelvic belt
5. Hip laterals
6. Trunk harness
7. Backrest
8. Laterals
9. Shoulder support
10. Chest harness
11. Kneepads
12. Headrest

### 10.1 ONE PIECE SEAT BASE CUSHION

The seat base cushion can be attached by simply setting it in place, then pressing down to locate the back snap fastener **A**. To secure further, attach the two side snap fasteners **B**. Hook the elastic tabs **C** to the upper leg guide locking lever **D** underneath the seat.



Always check the seat base cushion is secure before placing the child in the seat.

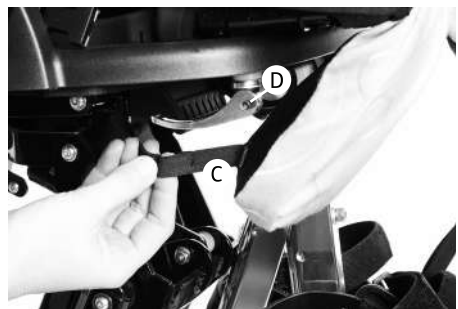



the tie down strap is clipped into a receiving buckle **C** on either side of the seat base. Finally secure the pelvic harness by attaching the centre plastic buckle **D**.

## 10.2 FLEXIBLE SACRAL CUSHION

The flexible sacral cushion can be attached by sliding it over the plastic tongue, using the fixing snap fastener to secure in place.



## 10.3 PELVIC HARNESS

The Pelvic Harness is attached by sliding the hip guides **A** into the pockets on the outer face of the harness. It is adjusted to the desired position by securing it to one of the snap fasteners **B** on the adjustable hip guide bracket. The buckle on

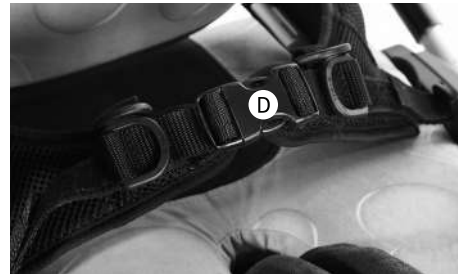
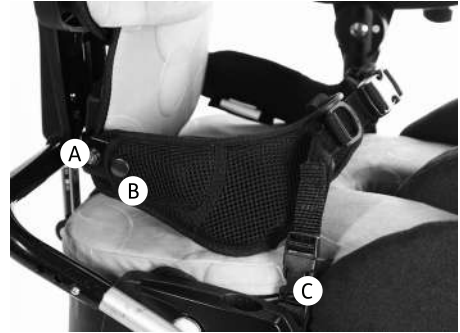

## 10.4 PELVIC CRADLE

Fasten the Pelvic Cradle and place on the seat base cushion. It is labelled to indicate the correct orientation. Press Velcro onto the seat base cushion and attach four buckles **A** to secure. There are two buckles at the back of the seat and one on either side.



## 10.6 HIP LATERALS

These hip laterals are used with the Pelvic Cradle only. Slide the cushion covers over the hip laterals hardware with the velcro flap to the outside.

Wrap the two velcro straps **A** round the bracket and stick onto the velcro pad **B**. Close over the flap.



## 10.5 GLUTEAL RAMP

If a gluteal ramp **B** is required, attach it to the Pelvic Cradle using the velcro side.



## 10.7 TRUNK HARNESS

With your trunk harness you will receive four adjustable side straps, two shoulder straps and brackets, the bolts, washers and locking nuts. Attach the shoulder straps into the shoulder section **A**.

The remaining four adjustable side straps are attached directly without using brackets, to the receiving holes either side of the backrest **B**. Simply attach the trunk harness to the connecting straps. The side straps are adjustable in length to accommodate outdoor clothing.

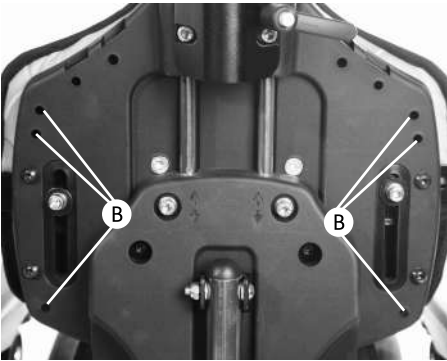
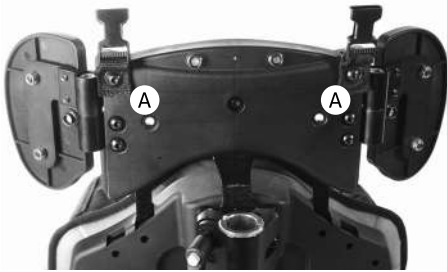

## 10.8 BACKREST CUSHION

If you have lateral supports fitted to your seat, adjust them to their maximum width before attaching the backrest cushion.

Slide the cushion down over the flexible sacral cushion and secure in place using the four snap fasteners in the backrest moulding. Align the lower fasteners first and snap in place, then secure the top fasteners.



## 10.9 LATERAL SUPPORT PADDED CUSHIONS

To attach the lateral support padded cushions, simply slide the cushions on with the padded side towards the inside of the seat. Feed the plastic buckle through the slot in the cover, then bring the two Velcro fastener straps around the bottom of the



To attach the lateral support padded cushions, simply slide the cushions on with the padded side towards the inside of the seat. Feed the plastic buckle through the slot in the cover, then bring the two Velcro fastener straps around the bottom of the moulding and attach them to the Velcro panel as shown. Close over the flap.



## 10.10 SHOULDER SUPPORT CUSHION

(if applicable)

First loosen the shoulder support laterals (see section 12). Slide the cushion over the assembly and secure using snap fasteners **A** in four places.



## 10.11 CHEST HARNESS

The chest harness can be attached by clipping the male buckle **A** into the female buckle at either side of the lateral supports.



## 10.12 KNEEPADS

Attach the kneepads with the snap fasteners **A** to the knee guides on the sides of the upper leg supports.



## 10.13 CONTOURED HEADREST CUSHION

To attach the headrest cushion, first place the polypropylene reinforcement between the cushion cover and the headrest assembly. It should not be zipped inside the cushion cover.



Then place the cushion onto the head support. Snap the central fastener and two side fasteners in place. Bring the lower flap under the head support and attach the velcro.



## 10.14 FLAT HEADREST CUSHION

Place the cushion on to the head support. Secure the central fastener. Bring the lower flap under the head support and secure with the two remaining fasteners. The headrest lateral covers are attached in the same way as the lateral support padded covers.



## SECTION 11: CLINICAL SETUP FOR POSTURAL MANAGEMENT

The clinical setup of the product should be completed by a technically and clinically competent person who has been trained in the use of the product. Leckey recommend a written record is maintained of all clinical setups for this product.

Set the backrest height, seat depth and footplate height before placing the child in the seat. These can be fine tuned when the child is in the seat.

## 11.1 PELVIC HARNESS

To adjust the depth of the pelvic harness, move the snap fastener to either position **B** or **C**. Adjust the support straps to the required length. Ensure the buckle connects securely in the middle **D**. If using the seat outdoors and your child is wearing a coat, position the pelvic harness under the coat.



Always attach the pelvic strap first before making any other adjustments.



## 11.2 PELVIC CRADLE

The Pelvic Cradle should be flat and open when the user is placed into the Mygo Seat - Size 3. All four side and back buckles should be already attached to the seat. First fasten the buckle **A** at the front of the Pelvic Cradle. Then fasten the Velcro **B** at the sides to fit the Pelvic Cradle to the user. Then adjust the front and rear straps **C** and **D** to secure to position the user's pelvis.





## 11.3 HIP LATERALS

(with Pelvic cradle only)

To set the width of the hip guides loosen the Allen bolts **A**, adjust to the desired width and retighten.

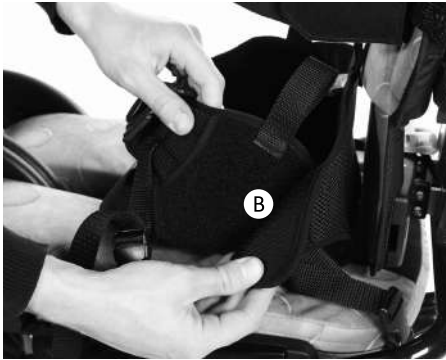

## 11.4 BACKREST DEPTH

The backrest depth is adjusted by depressing the popper then sliding the back support tube to the desired position. This is very important as it will ensure the seat will fit the child, both when they are upright and in a recline position.

There are three settings where the popper can be located.

We recommend that you measure the child's upper leg length to define the required seat depth (SD). To do this

measure from the child's lower back to the back of their knee. Then set



the backrest to position **A**, **B** or **C**. based on the table below.

Backrest depth	Size 3 (SD)
Position A	350 - 390mm / 13.8 - 15.4 inches
Position B	390 - 430mm / 15.4 - 16.9 inches
Position C	430 - 470mm / 16.9 - 18.5 inches



This backrest depth should not be adjusted while the child is in the seating system.



## 11.5 BACKREST HEIGHT

The overall height of the backrest can be adjusted by loosening the two socket cap bolts, then positioning to the required shoulder height of the user. Once in position the socket cap bolts should

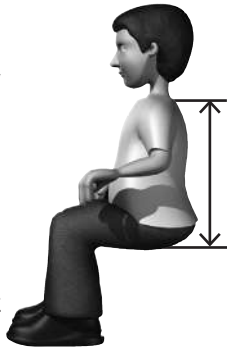

be retightened securely. The height can be fine tuned when the user is in the seat.

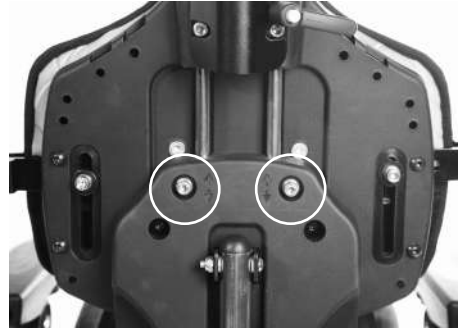

Use caution when adjusting to minimum setting as fingers could become trapped between moving and static parts.

## 11.6 BACKREST ANGLE

The backrest can be angled by loosening the bolt (A). Select the position you require then retighten the bolt securely. Always ensure the back angle is secure to maintain the desired posture for the child.

The backrest angle can be adjusted with the child in the seat, but always support the backrest with one hand.



Always make sure the bolt is secure as this could cause injury to the child or carer.

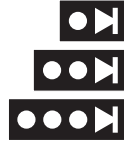

There are two angle indicator strips on either side of the back adjuster. We have supplied angle location markers (shown below) on a card. These can be applied to the clear strip on the adjuster tube to indicate the desired positions for various activities such as rest, feeding or play.

The angle indicator strip indicates the angle from the seat cushion to the backrest.



The black and yellow hazard strip on the inner tube indicates the maximum forward or prone position the backrest can be adjusted to.

## 11.7 ADJUSTING THE DYNAMIC BACKREST

To achieve the required amount of dynamic movement loosen the handle **A**, slide to the required position and retighten securely. To return the backrest to a static position, loosen the handle (a), slide the backrest strut to the bottom and retighten the handle.

To angle adjust the backrest where a dynamic backrest has been fitted, you use the handle at the base of the backrest. Pull the locking pin **C** and twist and unlock. Lift up the handle **B** and adjust the backrest. Pull the locking pin **C**. Ensure that the locking pin is secure.

The range of the backrest angle and the range of dynamic movement are a maximum of 30°, i.e. if the backrest is upright, a full 30° is available on the dynamic system. If the backrest angle is at 10° then only 20° of movement is available with the dynamic backrest and so on.



The backrest must be in the upright position with the dynamic function locked off (i.e. the handle to the lowest position on the backrest supine) and ensure the locking pin **C** is engaged when the seating system is used in transport.

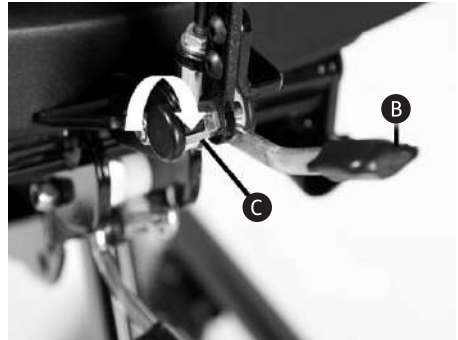

## 11.8 ADJUSTING THE UPPER LEG SUPPORTS

The upper leg supports will be set at the minimum position on arrival. Set the depth before placing the child in the seat. Fine adjustment is possible afterwards but is restricted by the user's weight. To achieve the correct position measure the length from the child's lower back to the back of their knee.

Loosen the locking levers **A** under the seat and slide leg support to required position. Keep the supports pointing straight forward

at this time unless wind sweeping or adduction, abduction must be accommodated, in which case set the angle accordingly. Retighten bolt. To increase the angle further, remove bolt and move leg angle to wider setting. Insert bolt into second slot **B** and tighten.

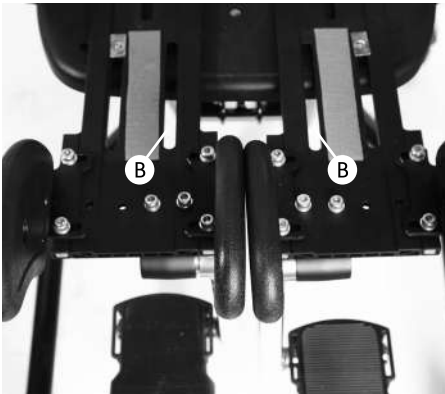
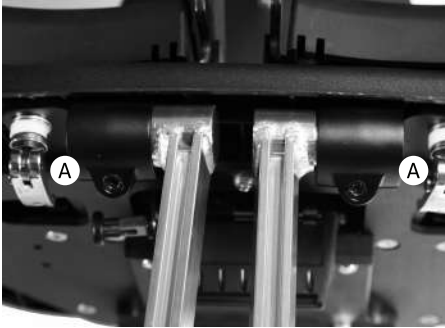

## 11.9 UPPER LEG GUIDE LATERAL SUPPORTS

To adjust the width or angle on the lateral supports, loosen the bolts **A** from above, move the guides and retighten the bolts.

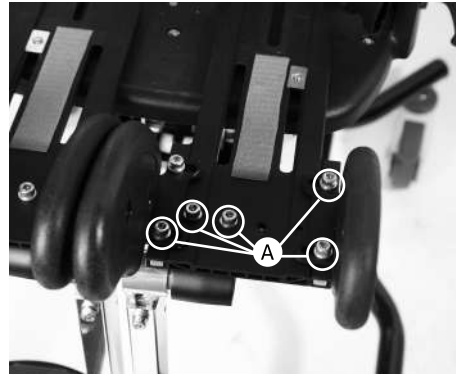

## 11.10 FOOTPLATE HEIGHT

To set the height of the footplate loosen the bolt **A** on the front of the calf support tube and slide the footplate to the required height and retighten the bolt.

To set the correct height of the footplate measure the distance from the back of the child's knee to the bottom of their heel.

You may have to adjust the angle to achieve the required foot position. To adjust the angle loosen the bolt **B** with the multi-tool, set to the desired angle and retighten. There is a safety popper to indicate maximum safe extension. This can be set with the child in the seat.





Always check the footplate is secure to prevent the user sliding forward and down in the seat which could pose a choking hazard if a chest or trunk harness is attached.

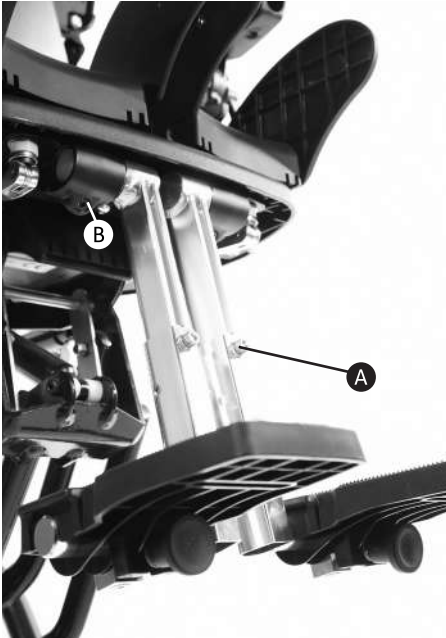

## 11.11 FOOTPLATE ANGLE ADJUSTMENT

To set the angle to accommodate plantarflexion or dorsiflexion, simply loosen or tighten the hand knob **A** to select the angle you require. The footplates can simply flip up to aid transfer.

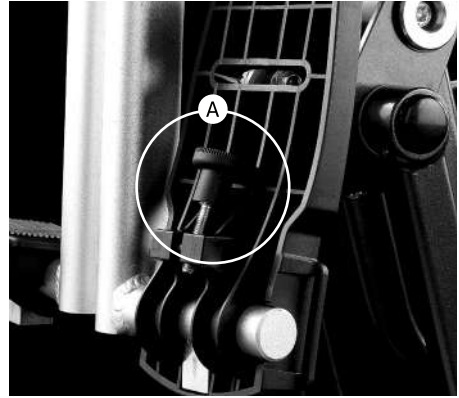

## 11.12 FLEXIBLE SACRAL SUPPORT

The flexible sacral support is used in conjunction with the pelvic positioning harness or Pelvic Cradle. To adjust the height, depth and angle, loosen the bolts on either side with the multi-tool provided.

Adjust the support to the correct angle then retighten the bolts. The support will flex back and forward to assist the child into the preferred posture.



Always use caution to ensure fingers do not become trapped when adjusting the sacral support.



## 11.13 LATERAL SUPPORTS

Loosen the socket cap **A** to adjust the width, height and angle of the lateral supports and retighten when you have achieved the desired position. To move flip away laterals, use knob **B**.

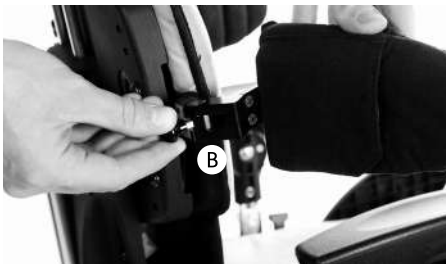

## 11.14 CHEST HARNESS

To change the width of the chest harness. Lift the front cover, adjust the Velcro straps to the desired width and replace the cover.



## 11.15 TRUNK HARNESS

When the child is out of the seating system the trunk harness will be open but remain attached by two side clips **A** on one side and one pelvic harness clip **B**. When placing the child in the seating system bring the trunk harness across the front and attach by connecting the clips into the buckles on the other side **C**.

Connect the remaining straps into the pelvic harness or Pelvic Cradle by feeding them through the loop **D** and snapping into place. Then connect the shoulder straps **E** into the clips at the top.

If your child is wearing outdoor clothing, the side straps can be opened by releasing the snap fasteners. The pelvic harness

connecting strap can be released by moving the strap to the lower snap fastener position. All the connecting straps are adjustable by lifting the cover, adjusting to the desired length and replacing the cover.



Check the laterals and harnesses regularly to ensure they have not become loose as without appropriate trunk support the child may be at risk of slipping into a position they cannot recover from. This could present a choking hazard.

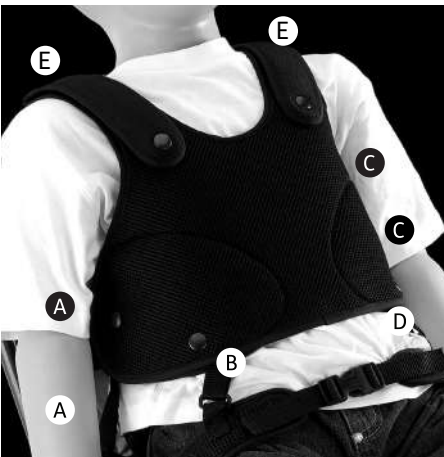

## 11.16 ADJUSTING THE KNEEPADS

The kneepads can be used as a limiter to help prevent the child from sliding forward in the seat. It can also be used above the knee to prevent the child from raising their foot. To adjust the kneepads lift the front cover adjust the Velcro straps to the desired length and reposition in place. To remove unclip the snap fastener on one side.



## 11.17 SANDALS

To position the user's feet in the sandals secure the Velcro straps provided so the foot is held in place. The straps should be placed over the bridge of the foot and over the toes. The front strap can be fed through one of two slots on either side of the sandals, depending on the size of the user's feet.



If the child is wearing sandals or light footwear check the straps to make sure the webbing does not irritate the skin.



## 11.18 SHOULDER SUPPORT LATERALS

To adjust the angle of the shoulder support laterals, loosen screw **A**, move laterals to required angle and retighten.

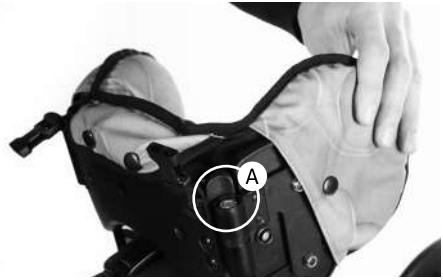

## 11.19 CONTOURED HEAD SUPPORT

To adjust the height, depth and angle of the contoured headrest, loosen the hand knobs **A** and when set to the desired position retighten the knobs. Do not remove the headrest while the user is in the seat.



Never use the headrest to force the position of the user's head.

Always use caution to ensure fingers do not become trapped when adjusting the headrest.



## 11.20 FLAT HEADREST WITH LATERAL SUPPORTS

To adjust the height, depth and angle of the flat headrest, adjust using the hand levers **A**, as shown on the contoured head support.

To adjust the width of the laterals loosen plastic knob **B**, slide to desired position and tighten securely.



## 11.21 ARMREST ADJUSTMENT

To adjust the height of the armrest loosen the hand knob **B**, set to the desired height and retighten. To adjust the angle, rotate ratchet handle **A** until the desired position has been achieved.

To remove the armrest completely, loosen ratchet handle **C**, press popper **D** and lift the armrest.



Always use caution as fingers could become trapped in the slot when adjusting the height.

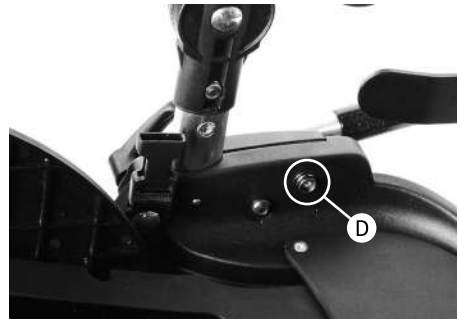
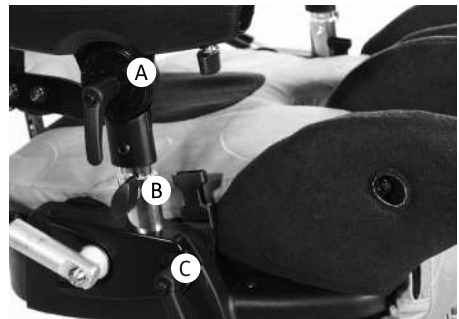

## 11.22 TRAY ADJUSTMENT

The height and angle of the tray are set by adjusting the armrests as detailed above. To remove or adjust the depth of the tray loosen the knobs **A** under the armrest, set to

the desired position and re-tighten securely.



Always use caution to ensure the child's hands or arms do not become trapped when inserting the tray.

Never use the tray to steer or push the chair.

Do not place objects, hotter than 40 degrees Celsius on the tray.

Please note that the tray is for the use of the user only. Do not lean or place objects on the tray, greater than 8kg (17.6lbs).



## 11.23 GRAB RAIL ADJUSTMENT

To set the depth of the grab rail to suit the child's reach, loosen knob **A**, adjust to the required depth and then re-tighten.

Do not adjust the horizontal bars beyond the moulding, except when you are removing the tray.



## SECTION 12: FREQUENT ADJUSTMENT FOR DAILY USE

(therapists/carers/parents)

Parents and carers should be shown how to make frequent adjustments and be made aware of the safety checks in Section 7 by a technically and clinically competent person who has been trained in the use of the product. Leckey recommend that a written record is maintained of all parents and carers who have been trained in the use of this product.

## 12.1 TRANSFERRING YOUR CHILD INTO & OUT OF THE SEAT

Before transferring the child into the seat carry out the daily product inspection as outlined in **section 14** of this user manual. Adjust the seat to a comfortable height to facilitate transfer. Lock all the castors, ensuring that they are facing outwards to maximise product stability. Make sure the safety buckle on the chest harness is released and is out of the way to facilitate transfer.

If the seat has flip-away thoracic laterals, first move these out of the way using knob **A**. Unclip the pelvic harness or Pelvic Cradle in the middle, undo the side velcro of the Pelvic Cradle and allow the harness to open out to facilitate transfer. Lastly, if sandals are fitted, open the straps. You are now ready to transfer or hoist the child into the seat.

The pelvic harness and Pelvic Cradle are fastened using the middle buckle, and side velcro (in the case of the Pelvic Cradle).



Always secure the pelvic harness or Pelvic Cradle first before fastening other buckles or harnesses. Adjust the harness so the child cannot slide or creep forward in the seat.



## 12.2 ADJUSTING THE PELVIC HARNESS OR PELVIC CRADLE

The correct positioning and tensioning of the pelvic harness or Pelvic Cradle is key to a child's postural management, affecting their comfort and ability to carry out activities. Please consult with your therapist to ensure the harness is positioned correctly and that the straps are tensioned appropriately.

To tension the pelvic harness straps and pads around the child pull the centre strap **A**. Pull the two side straps up to fine tune the pelvic position and adjust **B** the height of the pads on the hips.

To tension the Pelvic Cradle use the 4 side straps **C** and the velcro tabs **D**.

If using the seat outdoors and your child is wearing a coat, position the pelvic harness or Pelvic Cradle under the coat.

## Pelvic harness

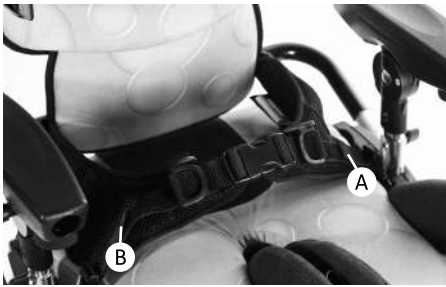

## Pelvic Cradle



If the child is active or has extensor spasms check the Pelvic harness or Pelvic Cradle is secure after each spasm to ensure the child is safe and cannot slide forward in the seat.

Always fasten the centre buckle on the pelvic harness or Pelvic Cradle before making any other adjustments.



## 12.3 CHASSIS

The Mygo Seat - Size 3 is designed to fit onto a range of chassis. This user manual shows the correct and safe use of the seating system with the Lecky Hi-low chassis. For all other chassis or bases please refer to the manufacturer's handbook.

To prepare the Hi-low chassis for the seating system we recommend that you raise the chassis to a comfortable



working height by pressing the foot lever at the rear of the chassis or by pressing the up button on the handset of the powered option.



## 12.4 POWERED HEIGHT ADJUSTMENT

The powered chassis can be easily adjusted with the push button control handset. The seat can be height adjusted with the client in the chair. Before the product is used for the first time it is recommended that the battery should be fully charged for 12 hours. To do this plug the adaptor into the mains socket and attach the lead (A) to the battery and switch on the mains supply power. When charged, switch off mains power, remove the adaptor plug and disconnect the lead from the battery. The battery charge should be topped up each day for approximately one hour. The chair can be adjusted in height while connected to the mains.

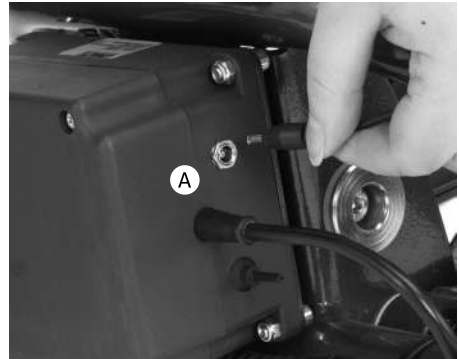

## 12.5 HEIGHT ADJUSTMENT – HI-LOW CHASSIS

You can carry out this adjustment with the child in the chair. To adjust the height of the Hi-low chassis, press the foot lever at the rear of the chassis, or press the up button on the handset of the powered option whilst holding the push handle. Once you remove your foot from the pedal or your thumb from the handset, the seat will be fixed at the chosen height.

For safety, the height adjustment pedal on the chassis can be locked by engaging the pull pin **C** on the right hand side of the pedal. To unlock, pull the pin out and rotate 90 degrees, the pedal can then be operated. The locking pin (C) should be kept in the locked position when you are not adjusting the chassis.

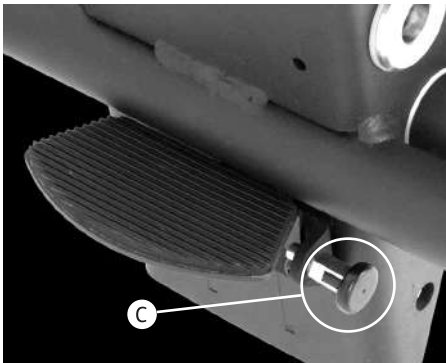

Always keep the locking pin engaged when you are not adjusting the chassis. This will prevent the foot pedal being operated accidentally.



For children over the weight of 27kg (60lbs), raising the manual chassis is a 2 person lift (UK lifting and handling regulations).

Always use caution as hands could become trapped when height adjusting the base.

## 12.6 TILT IN SPACE

The tilt-in-space can be angled while the user is in the seat. Before you adjust the tilt-in-space angle of the seat, always ensure the pelvic harness is secured preventing the user from sliding forward in the seat.

To adjust the tilt angle press the lever under the seat base. Once you have selected the angle you require, by simply removing your hand from the lever, the chair will be locked in position. The tilt-in-space should be locked off while the user is in the seat.

To lock the lever twist the pull pin to the right hand side of the lever and the pin will pop into position. You may have to lift the lever slightly to allow it to lock. To unlock pull the pin out and rotate 90 degrees, the lever can then be operated.



Always keep the tilt-in-space lever in the locked position to prevent accidental actuation of the lever which could cause the seat unit to jolt and possibly cause injury to the child.

Please use handle bars when operating tilt-in-space.

Always check with your therapist that the use of tilt-in-space will not cause any obstructions to the child's airways.

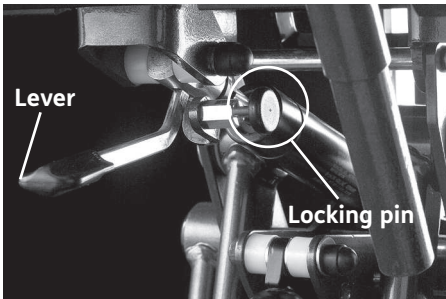

## 12.7 ADJUSTING THE DYNAMIC ABACKREST

The backrest must be in the upright position with the dynamic function locked off (i.e. the handle to the lowest position on the backrest supine) and ensure the locking pin (c) is engaged when the seating system is used in transport.



The backrest must be in the upright position with the dynamic function locked off (i.e. the handle to the lowest position on the backrest supine) and ensure the locking pin **C** is engaged when the seating system is used in transport.

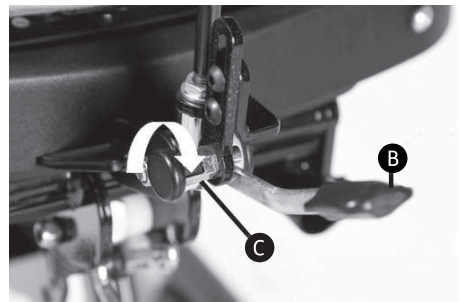
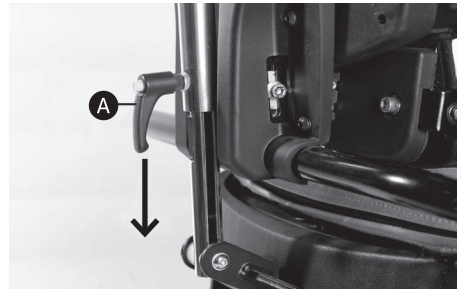

## 12.8 CHEST & TRUNK HARNESS ADJUSTMENT

If the child requires chest support as part of their postural support programme, the seat will be fitted with rigid laterals or a combination of laterals, chest harness and

trunk harness. These may need to be adjusted on a daily basis to accommodate differences in clothing.



Always check with your therapist as to the optimum positioning and tensioning of the straps and support items for the child.

To change the width of the chest harness, lift the front cover, adjust the Velcro straps and set to the desired width. When the correct width has been achieved replace the cover.

Please refer to **section 11** for specific guidance on adjusting the trunk harness.



Always make sure the plastic buckles are fully engaged when using the chest harness.

Check the harness and laterals are secure to ensure the child is safe and cannot slide forward in the seat as this may restrict their breathing.



## 12.9 SANDALS

To position the user's feet in the sandals, secure the Velcro straps provided so the foot is held in place. The straps should be placed over the bridge of the foot and over the toes. The front strap can be fed through one of two slots on either side of the sandals, depending on the size of the user's feet.



If the child is wearing sandals or light footwear check the straps to make sure the webbing does not irritate the skin.





## 12.10 TRAY ADJUSTMENT

The activity tray can be used for a range of functions and its position can be fine tuned to suit the user and the activity whether it is for fun, education or feeding. The tray is attached to the seat by inserting the tray tubes through the centre of the armrest. Once the tray is located in the position the knob **A** should be tightened securely. Adjust the armrests to set the height and angle of the tray.



To adjust the height of the armrest, loosen the hand knob **B**, set to the desired height and retighten. To adjust the angle, rotate hand knob **A** until the desired position has been achieved.

To remove the armrest completely for side transfer or assist in getting the child into or out of the seat loosen hand knob **C**, press popper **D** and lift the armrest.

Always use caution as fingers could become trapped in the slot when adjusting the height.

Always use caution to ensure the child's hands or arms do not become trapped when inserting the tray.

Never use the tray to steer or push the chair.

Do not place hot objects, greater than 40 degrees Celsius on the tray.

Please note that the tray is for the use of the user only. Do not lean or place heavy objects on the tray, not greater than 8kgs (17.6lbs).

## 12.11 ARMREST ADJUSTMENT

To adjust the height of the armrest, loosen the hand knob **B**, set to the desired height and retighten. To adjust the angle, rotate hand knob **A** until the desired position has been achieved.

To remove the armrest completely for side transfer or assist in getting the child into or out of the seat loosen hand knob **C**, press popper **D** and lift the armrest.

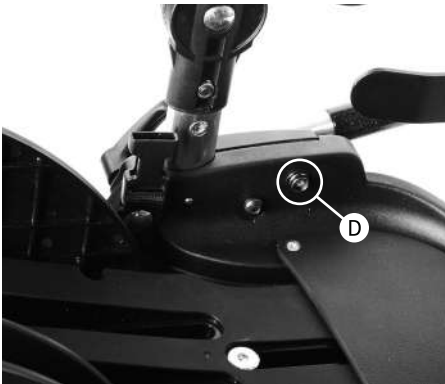
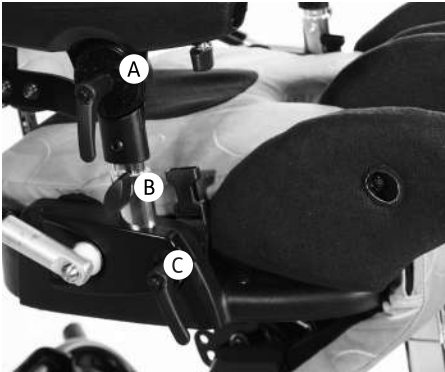

## 12.12 GRAB RAIL ADJUSTMENT

To set the depth of the grab rail to suit the child's reach, loosen knob **A**, adjust to the required depth and then re-tighten.

Do not adjust the horizontal bars beyond the mouldings, except when you are removing the tray.

To remove quickly, loosen knob **B** at either side and slide rail up vertically.

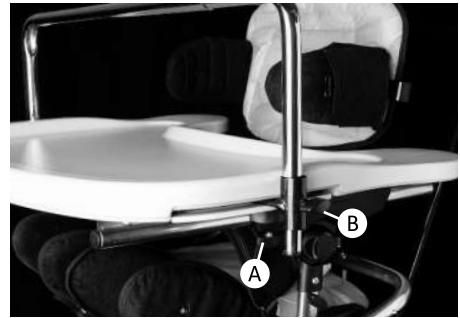

## 12.13 FREQUENT ADJUSTMENTS

To achieve the required amount of dynamic movement loosen the handle **A**, slide to the required position and retighten securely.

To return the backrest to a static position, loosen the handle **A**, slide the backrest strut to the bottom, retighten the handle.

To angle adjust the backrest where a dynamic backrest has been fitted,

you use the handle at the base of the backrest. Pull the locking pin **C** and twist and unlock. Lift up the handle **B** and adjust the backrest. Pull the locking pin **C**. Ensure that the locking pin is secure.

The range of the backrest angle and the range of dynamic movement are a maximum of 30°, i.e. if the backrest is upright, a full 30° is available on the dynamic system. If the backrest angle is at 10° then only 20° of movement is available with the dynamic backrest and so on.

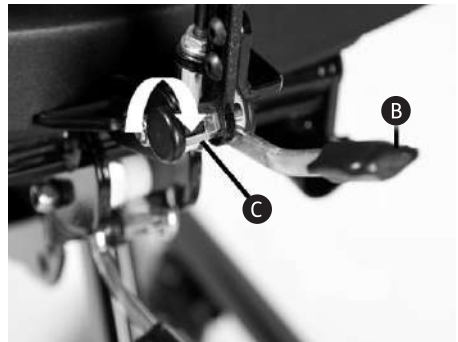
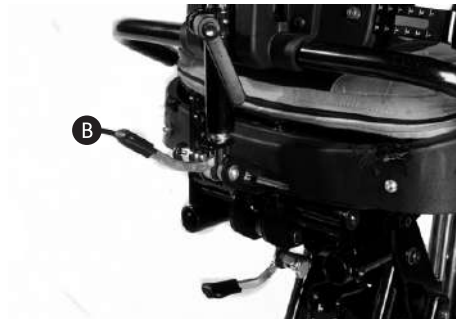
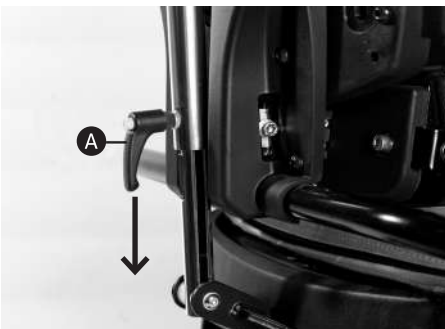
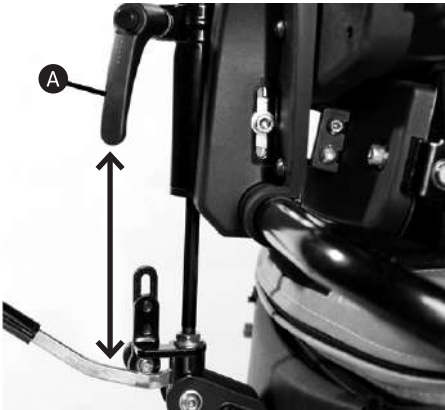

The backrest must be in the upright position with the dynamic function locked off (i.e. the handle to the lowest position on the backrest supine) and ensure the locking pin **C** is engaged when the seating system is used in transport.

## SECTION 13: CLEANING & CARE INFORMATION

### How to Maintain

When cleaning we recommend that you use only warm water and a non-abrasive detergent. Never use organic solvents or dry cleaning fluids.

### Upholstery and fabrics

1. The cushion covers can be removed, machine washed at 40°C and tumble dried at a low temperature.

Please remove the foam from the following covers before washing:

#### Headrest

#### Shoulder support

#### Backrest cushion

#### Seat base cushion

All other soft upholstery can be placed into the washing machine intact, after removing bolts and fastenings.



2. The upholstery and fabrics can also be cleaned by hand whilst in place. When cleaning we recommend that you use only warm water and a non-abrasive detergent.
3. Staining should be removed as quickly as possible with absorbent cloth, towels or a sponge. Routine soap and warm water sponging is effective for ordinary soiling and minor spills. Be careful not to over wet the fabric as this will cause the staining to spread.
4. Antiseptic cleaning agents can be used on more stubborn stains. These may require a safe solvent such as Isopropyl Alcohol or Mineral Spirit. A half cup of household bleach to 5 litres of water can also be used as a useful disinfectant.
5. The pelvic and trunk harnesses can be machine washed at 40 Deg C. Make sure all bolts and fasteners are removed first as they may cause damage to your washing machine. Store these in a safe place and out of reach from children.
6. Always ensure the product is dry before use.



## **Metal and plastic components**

1. Soap and water/antibacterial spray can be used for daily cleaning.
2. The chassis should be cleaned with a damp cloth- do not use running water.
3. Do not use solvents to clean plastic or metal components.
4. Make sure the product is dry before use.

## **SECTION 14: DAILY PRODUCT INSPECTION**

**(Therapists, parents & carers)**

We recommend that daily visual checks of the equipment are carried out by therapists, carers or parents to ensure the product is safe for use. The recommended daily checks are detailed below.

1. Check that there is no lateral movement or wobble in any of the moving parts. Ensure all adjustment knobs and bolts are in place and secure.
2. Check all upholstery and Velcro for signs of wear and tear.
3. Check all castors are moving freely and lock securely.
4. Ensure the handle and locking pin on the seat interface plate is

fully engaged and the seat unit is securely fixed onto the chassis.

5. Ensure the pelvic harness is fully secured around the user and they cannot slide or creep forward in the seat.
6. Ensure the footplate is attached securely.



If in any doubt to the continued safe use of your Leckey product or if any parts should fail, please cease using the product and contact our Customer Care Team or your local dealer as soon as possible.

## **SECTION 15: ANNUAL PRODUCT INSPECTION**

**(Therapist, Technician, Leckey Product Specialist, Dealer)**

Leckey recommend that each product should be subject to a detailed inspection at least once a year and every time the product is reissued for use. This inspection should be carried out by a technically competent person who has been trained in the use of the product and should include the following checks as a minimum requirement.

1. Check that there is no lateral movement or wobble in any of the moving parts. Ensure all adjustment knobs and bolts are in place and secure.
2. Check all ratchet handles, knobs, nuts, bolts and plastic buckles are in place, replacing any missing items. Paying particular attention to the following items;
  - Head support locking bolts.
  - Backrest height and angle adjustments bolts.
  - Seat depth adjustment bolts.
  - Pelvic harness / hip guide attachment bolts.
  - Footrest height and angle adjustment.
3. Check the chassis height adjustment mechanism is working properly. If the chassis is foot pedal operated ensure the seat height doesn't change when the pedal is released. Also, check that the locking pin engages securely to prevent accidental height adjustment of the chassis.
4. Adjust the seat to its maximum range of tilt-in-space and ensure that the locking lever locks the seat out securely at varying point in this range.
5. Check that where the seat and chassis join there is no visible wear and tear on the metal components.
6. Lift the base to check each castor individually. Make sure they are moving freely and remove any dirt from the rubber wheels. Check that the brakes lock the wheels securely.
7. Visually check the structure of the product paying attention to weld points on the frame ensuring there are no signs of fatigue or cracking around the welds.
8. Leckey recommend that a written record is maintained of all annual product inspections.



If in any doubt to the continued safe use of your Leckey product or if any parts should fail, please cease using the product and contact our Customer .

Care Team or your local dealer as soon as possible.

## **SECTION 16: RE-ISSUING LECKEY PRODUCTS**

Most Leckey products are assessed and ordered to meet the needs of an individual user. Before reissuing a product we recommend that the therapist prescribing the product has carried out an equipment compatibility check for the new user and has ensured that the product being re-issued contains no modifications or special attachments.

A detailed technical inspection should be carried out on the product prior to re-issuing. This should be carried out by a technically competent person who has been trained in the use and inspection of the product.

Please refer to section 15 for the required checks to be carried out.

Before re-issuing a product, it is recommended that it is disinfected using one of the following procedures:

Note: Always clean the product first to remove accumulated soiling prior to disinfecting/sanitising.

1. Where possible, we recommend the use of an automated “fogger” disinfection system that is used to completely cover the product surfaces with a disinfectant agent. The manufacturer’s instructions for the chosen system should be referred to prior to use and followed exactly.

2. Where an automated disinfection system is not available, all product surfaces should be wiped over with disinfectant surface wipes or liquid disinfectant on a soft cloth. Suitable products are 70% IPA, 70% Alcohol or diluted bleach. The manufacturer’s instructions for the chosen product should be followed. Product upholstery and fabrics should be cleaned thoroughly in accordance with section, Cleaning and Care Information, of this manual.

Ensure a copy of the user manual is supplied with the product. A copy can be downloaded from our website **[www.leckey.com](http://www.leckey.com)**

Leckey recommend that a written record is maintained of all product inspections carried out during the reissue of the product.



If in any doubt to the continued safe use of your Leckey product or if any parts should fail, please cease using the product and contact our Customer Care Team or your local dealer as soon as possible.

## **SECTION 17: PRODUCT SERVICING**

Servicing of all Leckey products should only be carried out by technically competent persons who have been trained in the use of the product.

All international service enquiries should be directed to the appropriate Leckey distributor who will be delighted to assist you. For further information on Leckey distributors please visit our website **[www.leckey.com](http://www.leckey.com)**

## SECTION 18: TECHNICAL INFORMATION

### Product and Accessory Codes

185-600	Seat Shell Size 3
185-2851-09	Seat Covers Size 3 - Pink
185-2851-08	Seat Covers Size 3 - Blue
185-2851-07	Seat Covers Size 3 - Orange
185-2851-06	Seat Covers Size 3 - Grey

### Chassis

102-2769	Indoor-Outdoor Hi-Low with powered lift
102-2768	Indoor-Outdoor Hi-Low with hydraulic manual lift
102-2767	Indoor-Outdoor Hi-Low with gas powered manual lift
102-2766	Indoor Hi-Low with hydraulic manual lift
102-2754	Hi-Low Chassis - Powered - Complete
102-2753	Hi-Low Chassis - Foot pedal - Complete

### Accessories

117-802	Pelvic Harness & Brackets - Medium
133-731	Pelvic Cradle Size 3
133-730	Pelvic Cradle Size 2
137-632	Hip Laterals
185-604	Arm Rest Size 3
117-2776	Footplate Size 2
152-3600	Sandals Size 3
185-633	Size 3 Rigid Laterals (with cover)
117-837	Flipaway Lateral Supports
137-632	Hip Laterals
117-765	Knee Pads
137-699-05	Contoured Headrest Assembly and Cushion
185-611	Size 3 Tray (Grey)
117-769	Grab Rails
AH02	Ankle Huggers- Medium

## LECKEY HI LOW BASE OPTIONS

Technical Details	
Size	Size 3
Age (Years Approx)	10-16
<b>User Weight</b>	
min	18kg / 40lbs
max	70kg / 154lbs
<b>User Height</b>	
min	150cm / 59"
max	175cm / 69"
<b>Seat Width</b>	
min	250mm / 9.8"
max	400mm / 15.7"
<b>Seat Depth</b>	
min	350mm / 13.8"
max	470mm / 18.5"
<b>Knee Width</b>	
min	120mm / 4.7"
max	140mm / 5.5"
<b>Footplate angle</b>	
Abduction	20°
Adduction	12°
Plantarflexion/Dorsiflexion	10°
<b>Chest Width</b>	
min	200mm / 7.8"
max	300mm / 11.8"
<b>Backrest Height</b>	
min	460mm / 18.1"
max	570mm / 22.4"
<b>Backrest Angle:</b>	
Prone	10°
Recline	25°
<b>Seat to Sandal</b>	
min	315mm / 12.4"
max	470mm / 18.5"
<b>Top of Seat to Floor</b>	
min	360mm / 14.2"
max	700mm / 27.5"
<b>Armrest Height</b>	
	210mm / 8.3"
	260mm / 10.2"
<b>Tray Size</b>	
	550 x 480mm
	21.6 x 18.9"

### 6.3 LINAK Actuator specification - 281209-01

Rated IP51

Duty Cycle Max 10% or 2 min continuous use followed by 18 min not in use.

Ambient temp +5deg to +40deg C

Ambient Operating temp 22deg

Storage temp -40deg C to 70degC

Push Max 3500N

Pull Max 2000N

Self Lock at 3500N Push – 2000N Pull

Typical speed with full load 4.7mm/sec

Max amps at load of 3500N is 3.9 amps

Noise level dB(A) 48

Power input voltage 24v +- 10%

### 6.4 LINAK Battery Box - BA18021-00

Rated IP51

Ambient temp +5deg to 40deg C

Storage temp -20deg C to 60deg C

Rated Capacity 1.2 Ah 24v

Charging current is max 0.3A

Lead acid gel filled battery

Charging current Max 500mA

### 6.5 LINAK Handset - HB41000-00004

Green LED for power on

Rated IP51

Yellow LED for charging function

Control current 100mA per channel (Max)

Yellow LED turns into green when batteries are fully charged.

Ambient temp +5deg to +40deg C

LINAK products may be stored in non-heated storage facilities with humidity between 0 and 100%, none condensing. None condensing means that one should not take a product from an ice cold warehouse into a room with a temperature of 20deg C; if this is done then moistness will appear on the products.

LINAK Battery Charger - CH01



















Mains 100-240 VAC/50-60 Hz switch mode power supply

Charging voltage 27.6 VDC +- 2%

#### Technical Details

<b>Foot Pedal (Top of seat to floor)</b>	Min 340cm / 13 inches	Max 655cm / 26 inches
<b>Powered (Top of Seat to Floor)</b>	Min 370cm / 15 inches	Max 675cm / 27 inches
<b>Tilt in Space:</b>		137-600
Prone	10°	
Recline	25°	
<b>Base Weight</b>	12kg	26.5lbs

## SECTION 19: TABLE OF SYMBOLS

Symbol	Meaning
	Medical Device
	Read the Instructions for Use
	CE mark
	Warning
	Do not dispose in domestic waste
	Manufacturer
	Model Number
	Serial Number
	Max Occupancy Weight
	Date of Manufacturer
	Latex Free
	Unique Device Identification
	Crash Tested
	Machine wash - water temp 40°C
	Tumble dry - low heat
	Do not iron
	Do not bleach
	Handwash
	Do not dry-clean







**USA Distributor**

Sunrise Medical (US) LLC  
2842 N Business Park Avenue  
Fresno, CA 93727

T: 1-800-333-4000  
F: 1-800-300-7502  
E: customseating@sunmed.com

[sunrisemedical.com](http://sunrisemedical.com)

**Canadian Distributor**

Sunrise Medical  
237 Romina Drive, Unit 3,  
Concord, ON, L4K 4V3

T: +1.800.263.3390  
F: +1.800.561.5834  
E: mkt.canada@sunmed.com

[sunrisemedical.ca](http://sunrisemedical.ca)

Please visit [leckey.com](http://leckey.com) for a full list of Leckey distributors.

---

James Leckey Design Limited  
19 Ballinderry Road  
Lisburn, BT28 2SA  
Northern Ireland

**(+44) 28 9260 0750**  
[hello@leckey.com](mailto:hello@leckey.com)

[leckey.com](http://leckey.com)

