

Fitting / Order form

F5 Corpus (PPP)

Prices valid from: Jan-24



F5 Corpus (PPP)

Front wheel drive power chair with Power Platform and Quick Configurator  
As standard, equipped with pneumatic or solid tyres, 85 Ah maintenance free batteries, charger & 12 km/h top speed.  
The F5 Corpus is prepared to be equipped with bio mechanic powered backrest, elevating & articulating leg rests, seat elevation & anterior/posterior tilt power functions. The F5 can be accessorised with the direct mount ROHO Agility backs & Bodilink postural management aids

Dealer information	
Customer (name / code)	/
Contact	
Address	
Post code / City	/
Phone / Fax	/
Client Information	
Name	/
Address	
Post code / City	/
Phone	
E-mail	

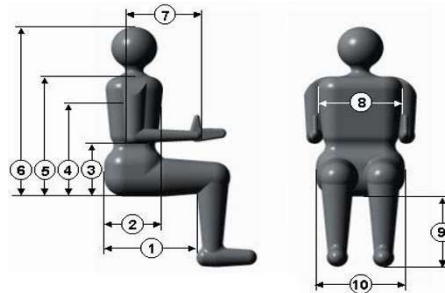

Anatomic Dimension

Diagnosis		Weight:	kg	3:	cm	7:	cm
		Height:	cm	4:	cm	8:	cm
		1:	cm	5:	cm	9:	cm
		2:	cm	6:	cm	10:	cm

Fitting date		Fitting date (dd-mm-yyyy)				
Article code	Position Left Right	Price excl VAT	Price incl VAT	Funding code	Additional Info	<input checked="" type="checkbox"/> Required choice <input type="checkbox"/> / <input type="radio"/> Optional choice <input type="checkbox"/> / <input checked="" type="radio"/> Default required option

Chassis						
F5 CORPUS R-NET	108992-99-0	<input checked="" type="checkbox"/>		10494.00		
PROTECTION PLAN F/M5	109389-99-0	<input type="checkbox"/>		1500.00		
MAX SPEED 12KMH	107306-99-0	<input checked="" type="radio"/>		0.00		
MAX SPEED 10KMH	107305-99-0	<input type="radio"/>		0.00		
Mud guards rear						
MUDGUARD KIT	108445-99-0	<input type="checkbox"/>		90.00		
Accent colour						
Chassis / Wheels (no charge)						
COVER ACCENT COLOUR AQUA	108432-99-0	<input type="radio"/>	<input type="radio"/>	0.00		
COVER ACCENT COLOUR SKY	108433-99-0	<input type="radio"/>	<input type="radio"/>	0.00		
COVER ACCENT COLOUR VIOLET	108434-99-0	<input type="radio"/>	<input type="radio"/>	0.00		
COVER ACCENT COLOUR FLAMINGO	108435-99-0	<input type="radio"/>	<input type="radio"/>	0.00		
COVER ACCENT COLOUR CHILI	109327-99-0	<input type="radio"/>	<input type="radio"/>	0.00		
COVER ACCENT COLOUR CANARY	108437-99-0	<input type="radio"/>	<input type="radio"/>	0.00		
COVER ACCENT COLOUR SPRING	108438-99-0	<input type="radio"/>	<input type="radio"/>	0.00		
COVER ACCENT COLOUR ARCTIC	108439-99-0	<input type="radio"/>	<input type="radio"/>	0.00		
COVER ACCENT COLOUR SUNSET	108440-99-0	<input type="radio"/>	<input type="radio"/>	0.00		
COVER ACCENT COLOUR MIDNIGHT	108441-99-0	<input type="radio"/>	<input type="radio"/>	0.00		
COVER ACCENT COLOUR GOLD	108442-99-0	<input type="radio"/>	<input type="radio"/>	143.00		
COVER ACCENT COLOUR BRONZE	108443-99-0	<input type="radio"/>	<input type="radio"/>	143.00		
COVER ACCENT COLOUR PLATINUM	108444-99-0	<input type="radio"/>	<input type="radio"/>	143.00		

Drive wheels						
WHEELS 3.00x8" AIR FILLED TIRES BLACK	108411-99-0	<input checked="" type="radio"/>	0.00			
WHEELS 3.00x8" SOLID TIRES BLACK	108414-99-0	<input type="radio"/>	0.00			
WHEELS 3.00x8" AIR FILLED TIRES/SNOW AND MUD BLACK	108412-99-0	<input type="radio"/>	0.00			
Caster wheels						
WHEELS 210X65 AIR FILLED TIRES BLACK	108408-99-0	<input checked="" type="radio"/>	0.00			
WHEELS 210X65 SOLID TIRES BLACK	108409-99-0	<input type="radio"/>	0.00			
Batteries						
BATTERIES, 85Ah, SET OF 2 PERMOBIL	108999-99-0	<input checked="" type="radio"/>	0.00			
WITHOUT BATTERIES	100661-99-0	<input type="radio"/>	0.00			
Charger						
CHARGER VOLTPRO 24/10 PERMOBIL GEL-AGM IP44 EU	109166-99-0	<input checked="" type="radio"/>	0.00			
WITHOUT CHARGER	100662-99-0	<input type="radio"/>	0.00			
Light kit						
LIGHT KIT	109385-99-0	<input checked="" type="radio"/>	435.00			
REFLECTOR KIT	108415-99-0	<input type="radio"/>	0.00			
Anti-tippers						
ANTI TIPPER WHEELS	106997-99-0	<input type="checkbox"/>	0.00			
Accessories chassis						
LUGGAGE CARRIER WITH REFLECTORS	109170-99-0	<input type="radio"/>	313.00			
LUGGAGE CARRIER WITH TAIL LIGHTS	109169-99-0	<input type="radio"/>	525.00			
WITHOUT LUGGAGE CARRIER	109284-99-0	<input checked="" type="radio"/>	0.00			
PREPARED FOR DAHL CARLOCK	108254-99-0	<input type="radio"/>	167.00			
MOUNTDAHL LOCKING PLATE	109019-99-0	<input type="radio"/>	557.00			
OPTION NOT REQUIRED		<input checked="" type="radio"/>				
REMOTE STOP (2CH)433MHZ (EU)	110285-99-0	<input type="checkbox"/>	604.00			
TARPAULIN/RAINCOVER FOR ALL MODLES (NYLON)	101888-99-0	<input type="radio"/>	138.00			
TARPAULIN/RAINCOVER YELLOW (WATERPROOF)	101897-99-0	<input type="radio"/>	313.00			
OPTION NOT REQUIRED		<input checked="" type="radio"/>				
Seat assembly						
SEAT HEIGHT FIXED	107097-99-0	<input checked="" type="radio"/>	0.00			
POWERED SEAT LIFT	107098-99-0	<input type="radio"/>	848.00			
FIXED SEAT ANGEL	107096-99-0	<input checked="" type="radio"/>	0.00			
POWERED ADJ. SEAT TILT 50°	107095-99-0	<input type="radio"/>	1961.00			
WITHOUT ANTERIOR/NEGATIVE SEAT TILT	107093-99-0	<input checked="" type="radio"/>	0.00			
5° ACTIVE SEATING	107099-99-0	<input type="radio"/>	0.00			
10° ACTIVE SEATING	107090-99-0	<input type="radio"/>	0.00			
20° ACTIVE SEATING (REQ. LEGREST(X)+KNEESUPPORT)	107091-99-0	<input type="radio"/>	0.00			
45° ACTIVE SEATING (REQ. LEGREST(X)+KNEESUPPORT)	107092-99-0	<input type="radio"/>	0.00			



Seat														
SEAT CORPUS		109017-99-0		<input checked="" type="checkbox"/>		0.00								
Seat sizes														
		Depth												
Size (mm)		370 14"	395 15"	420 16"	445 17"	470 18"	495 19"	520 20"	545 21"	570 22"				
Width	420mm/16"	<input type="checkbox"/>	<input type="checkbox"/>	<input type="checkbox"/>	<input type="checkbox"/>	<input type="checkbox"/>	<input type="checkbox"/>	<input type="checkbox"/>	<input type="checkbox"/>	<input type="checkbox"/>	<input type="checkbox"/> No matching seat cushion size			
	470mm/18"	<input type="checkbox"/>	<input type="checkbox"/>	<input type="checkbox"/>	<input type="checkbox"/>	<input type="checkbox"/>	<input type="checkbox"/>	<input type="checkbox"/>	<input type="checkbox"/>	<input type="checkbox"/>				
	520mm/20"	<input type="checkbox"/>	<input type="checkbox"/>	<input type="checkbox"/>	<input type="checkbox"/>	<input type="checkbox"/>	<input type="checkbox"/>	<input type="checkbox"/>	<input type="checkbox"/>	<input type="checkbox"/>				
	570mm/22"	<input type="checkbox"/>	<input type="checkbox"/>	<input type="checkbox"/>	<input type="checkbox"/>	<input type="checkbox"/>	<input type="checkbox"/>	<input type="checkbox"/>	<input type="checkbox"/>	<input type="checkbox"/>				
Seat cushion														
SEAT CUSHION CORPUS ERGO VINYL		10XXXX-99-0		<input checked="" type="checkbox"/>		0.00								
SEAT CUSHION CORPUS ERGO STRETCH AIR		10XXXX-99-0		<input type="checkbox"/>		0.00								
WITHOUT SEAT CUSHION		105118-99-0		<input type="checkbox"/>		-101.00								
ERGO SUPPORTS SEAT CUSHION		105219-99-0		<input checked="" type="checkbox"/>		0.00								
Adjustment backrest														
POWERED ADJ. BACKREST 150° (LA28)		107825-99-0		<input type="checkbox"/>		1161.00								
POWERED ADJ. BACKREST 180° (LA28)		107755-99-0		<input type="checkbox"/>		1161.00								
MANUAL ADJUST. BACKREST		108195-99-0		<input checked="" type="checkbox"/>		0.00								
BACKREST FIXED		105066-99-0		<input checked="" type="checkbox"/>		0.00								
BACKREST BIO-MECH		105067-99-0		<input type="checkbox"/>		742.00								
Backrest type														
SHORT		107262-99-0		<input type="checkbox"/>		0.00								
STANDARD		107264-99-0		<input checked="" type="checkbox"/>		0.00								
DIRECT BACKREST ADAPTER		107261-99-0		<input type="checkbox"/>		435.00								
TUBELAR BACKREST ADAPTER		107265-99-0		<input type="checkbox"/>		477.00								
WITHOUT BACKREST SHELL		107272-99-0		<input type="checkbox"/>		-133.00								
Backrest sizes														
		Short		Standard heights										
Size (mm)		470	545	570	595	620	645	670						
Width	360	<input type="checkbox"/>	<input type="checkbox"/>	<input type="checkbox"/>	<input type="checkbox"/>	<input type="checkbox"/>	<input type="checkbox"/>	<input type="checkbox"/>						
	410	<input type="checkbox"/>	<input type="checkbox"/>	<input type="checkbox"/>	<input checked="" type="checkbox"/>	<input type="checkbox"/>	<input type="checkbox"/>	<input type="checkbox"/>						
	460	<input type="checkbox"/>	<input type="checkbox"/>	<input type="checkbox"/>	<input type="checkbox"/>	<input type="checkbox"/>	<input type="checkbox"/>	<input type="checkbox"/>						
	510	<input type="checkbox"/>	<input type="checkbox"/>	<input type="checkbox"/>	<input type="checkbox"/>	<input type="checkbox"/>	<input type="checkbox"/>	<input type="checkbox"/>						
Backrest cushion														
BACKREST CUSHION VINYL		10XXXX-99-0		<input checked="" type="checkbox"/>		0.00								
BACKREST CUSHION STRETCH AIR		10XXXX-99-0		<input type="checkbox"/>		0.00								
WITHOUT BACKREST CUSHION		105117-99-0		<input type="checkbox"/>		-101.00								
ERGO SUPPORTS BACK SMALL (5 CM DEEP)		105569-99-0		<input checked="" type="checkbox"/>		0.00								
ERGO SUPPORTS BACK LARGE (7 CM DEEP)		105570-99-0		<input type="checkbox"/>		0.00								
Agility Max Contour														
		(H) Height		(MH) Mounting height										
(W) Size ("/mm)		16"	18"	20"	16"							18"	20"	
Width	14"/355mm	<input type="checkbox"/>	<input type="checkbox"/>	<input type="checkbox"/>	470mm							<input type="checkbox"/>	<input type="checkbox"/>	<input type="checkbox"/>
	15"/380mm	<input type="checkbox"/>	<input type="checkbox"/>	<input type="checkbox"/>	495mm							<input type="checkbox"/>	<input type="checkbox"/>	<input type="checkbox"/>
	16"/405mm	<input type="checkbox"/>	<input type="checkbox"/>	<input type="checkbox"/>	520mm							<input type="checkbox"/>	<input type="checkbox"/>	<input type="checkbox"/>
	17"/430mm	<input type="checkbox"/>	<input type="checkbox"/>	<input type="checkbox"/>	545mm							<input type="checkbox"/>	<input type="checkbox"/>	<input type="checkbox"/>
	18"/455mm	<input type="checkbox"/>	<input type="checkbox"/>	<input type="checkbox"/>	570mm							<input type="checkbox"/>	<input type="checkbox"/>	<input type="checkbox"/>
	19"/485mm	<input type="checkbox"/>	<input type="checkbox"/>	<input type="checkbox"/>	595mm							<input type="checkbox"/>	<input type="checkbox"/>	<input type="checkbox"/>
	20"/510mm	<input type="checkbox"/>	<input type="checkbox"/>	<input type="checkbox"/>	620mm							<input type="checkbox"/>	<input type="checkbox"/>	<input type="checkbox"/>
OPTION NOT REQUIRED		<input checked="" type="checkbox"/>		<input type="checkbox"/>								645mm	<input type="checkbox"/>	<input type="checkbox"/>

Mounting armrests																																																					
WIDTH BETWEEN ARMRESTS: NARROW (38-48CM)	107251-99-0	<input checked="" type="radio"/>	0.00																																																		
WIDTH BETWEEN ARMRESTS: WIDE (48-58CM)	107252-99-0	<input type="radio"/>	0.00																																																		
WIDTH BETWEEN ARMRESTS SET TO 380MM	105083-99-0	<input type="radio"/>	0.00																																																		
WIDTH BETWEEN ARMRESTS SET TO 430MM	105084-99-0	<input checked="" type="radio"/>	0.00																																																		
WIDTH BETWEEN ARMRESTS SET TO 480MM	105085-99-0	<input type="radio"/>	0.00																																																		
WIDTH BETWEEN ARMRESTS SET TO 530MM	105086-99-0	<input type="radio"/>	0.00																																																		
WIDTH BETWEEN ARMRESTS SET TO 580MM	105082-99-0	<input type="radio"/>	0.00																																																		
ARMREST HEIGHT POS 1: 230MM (FROM SEAT PAN)	106631-99-0	<input type="radio"/>	0.00																																																		
ARMREST HEIGHT POS 2: 255MM (FROM SEAT PAN)	106632-99-0	<input type="radio"/>	0.00																																																		
ARMREST HEIGHT POS 3: 280MM (FROM SEAT PAN)	106633-99-0	<input checked="" type="radio"/>	0.00																																																		
ARMREST HEIGHT POS 4: 305MM (FROM SEAT PAN)	106634-99-0	<input type="radio"/>	0.00																																																		
ARMREST HEIGHT POS 5: 330MM (FROM SEAT PAN)	106635-99-0	<input type="radio"/>	0.00																																																		
ARMREST HOLDERS FIXED	105070-99-0	<input checked="" type="radio"/>	0.00																																																		
ARMREST HOLDERS SWIVEL	105072-99-0	<input type="radio"/>	180.00																																																		
<b>Armrests</b>																																																					
		<table border="1"> <thead> <tr> <th colspan="4">Left</th> <th colspan="4">Right</th> </tr> <tr> <th>260</th> <th>335</th> <th>410</th> <th>460</th> <th>260</th> <th>335</th> <th>410</th> <th>460</th> </tr> </thead> <tbody> <tr> <td><input type="radio"/></td> <td><input type="radio"/></td> <td><input type="radio"/></td> <td><input type="radio"/></td> <td><input type="radio"/></td> <td><input type="radio"/></td> <td><input type="radio"/></td> <td><input type="radio"/></td> </tr> <tr> <td><input type="radio"/></td> <td><input type="radio"/></td> <td><input type="radio"/></td> <td><input type="radio"/></td> <td><input type="radio"/></td> <td><input type="radio"/></td> <td><input type="radio"/></td> <td><input type="radio"/></td> </tr> <tr> <td><input type="radio"/></td> <td><input checked="" type="radio"/></td> <td><input type="radio"/></td> <td><input type="radio"/></td> <td><input type="radio"/></td> <td><input checked="" type="radio"/></td> <td><input type="radio"/></td> <td><input type="radio"/></td> </tr> <tr> <td><input type="radio"/></td> <td><input type="radio"/></td> <td><input type="radio"/></td> <td><input type="radio"/></td> <td><input type="radio"/></td> <td><input type="radio"/></td> <td><input type="radio"/></td> <td><input type="radio"/></td> </tr> </tbody> </table>	Left				Right				260	335	410	460	260	335	410	460	<input type="radio"/>	<input type="radio"/>	<input type="radio"/>	<input type="radio"/>	<input type="radio"/>	<input type="radio"/>	<input type="radio"/>	<input type="radio"/>	<input type="radio"/>	<input type="radio"/>	<input type="radio"/>	<input type="radio"/>	<input type="radio"/>	<input type="radio"/>	<input type="radio"/>	<input type="radio"/>	<input type="radio"/>	<input checked="" type="radio"/>	<input type="radio"/>	<input type="radio"/>	<input type="radio"/>	<input checked="" type="radio"/>	<input type="radio"/>	<input type="radio"/>	<input type="radio"/>	<input type="radio"/>	<input type="radio"/>	<input type="radio"/>	<input type="radio"/>	<input type="radio"/>	<input type="radio"/>	<input type="radio"/>			
Left				Right																																																	
260	335	410	460	260	335	410	460																																														
<input type="radio"/>	<input type="radio"/>	<input type="radio"/>	<input type="radio"/>	<input type="radio"/>	<input type="radio"/>	<input type="radio"/>	<input type="radio"/>																																														
<input type="radio"/>	<input type="radio"/>	<input type="radio"/>	<input type="radio"/>	<input type="radio"/>	<input type="radio"/>	<input type="radio"/>	<input type="radio"/>																																														
<input type="radio"/>	<input checked="" type="radio"/>	<input type="radio"/>	<input type="radio"/>	<input type="radio"/>	<input checked="" type="radio"/>	<input type="radio"/>	<input type="radio"/>																																														
<input type="radio"/>	<input type="radio"/>	<input type="radio"/>	<input type="radio"/>	<input type="radio"/>	<input type="radio"/>	<input type="radio"/>	<input type="radio"/>																																														
WITHOUT ARMREST			-45.00																																																		
TEXTILE ARMREST			0.00																																																		
VINYL ARMREST			0.00																																																		
GEL ARMREST			148.00	each																																																	
MOLDED ARMREST LEFT	108860-99-0	<input type="checkbox"/>	159.00																																																		
MOLDED ARMREST RIGHT	108861-99-0	<input type="checkbox"/>	159.00																																																		
MOLDED HAND PAD MEDIUM LEFT	108862-99-0	<input type="radio"/>	64.00																																																		
MOLDED HAND PAD LARGE LEFT	108864-99-0	<input type="radio"/>	64.00																																																		
OPTION NOT REQUIRED		<input checked="" type="radio"/>																																																			
MOLDED HAND PAD MEDIUM RIGHT	108863-99-0	<input type="radio"/>	64.00																																																		
MOLDED HAND PAD LARGE RIGHT	108865-99-0	<input type="radio"/>	64.00																																																		
OPTION NOT REQUIRED		<input checked="" type="radio"/>																																																			
<b>Legrest</b>																																																					
LEGREST W. 205MM LENGTH COMPENSATION	107012-99-0	<input checked="" type="radio"/>	0.00																																																		
LEGREST W. 185MM LENGTH COMPENSATION	107184-99-0	<input type="radio"/>	0.00																																																		
WITHOUT LEGREST	105760-99-0	<input type="radio"/>	0.00																																																		
<b>Adjustment legrest</b>																																																					
POWERED ADJ. LEGREST CORPUS (LA28)	107757-99-0	<input type="radio"/>	1378.00																																																		
POWERED ADJ. LEGREST CORPUS POW EXT LEG (LA28)	107758-99-0	<input type="radio"/>	2544.00																																																		
MANUAL ADJUSTMENT LEGREST (BRACKET LA28)	107763-99-0	<input checked="" type="radio"/>	0.00																																																		
<b>Footplates</b>																																																					
DUAL FOOTPLATE 16CM LEG LENGTH 29-50CM AL.	105436-99-0	<input checked="" type="radio"/>	0.00																																																		
DUAL FOOTPLATE 20CM LEG LENGTH 29-50CM	105437-99-0	<input type="radio"/>	0.00																																																		
FOOTPLATE 1 PIECE LEG LENGTH 29-50CM	106760-99-0	<input type="radio"/>	0.00																																																		
DUAL FOOTPLATE 16CM LEG LENGTH 14-30CM AL.	105438-99-0	<input type="radio"/>	0.00																																																		
DUAL FOOTPLATE 20CM LEG LENGTH 14-30CM	105439-99-0	<input type="radio"/>	0.00																																																		
FOOTPLATE CHOICE NOT REQUIRED	106154-99-0	<input type="radio"/>	0.00																																																		

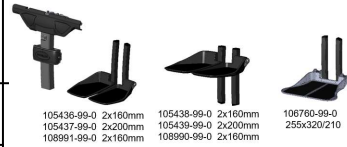
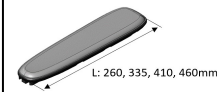

		Accessories seat			
Headrest					
<b>Corpus</b>					
HEAD SUPPORT, ADJUSTABLE TEXTILE(BLACK)	106336-99-0	<input type="radio"/>	235.00		
HEAD SUPPORT, ADJUSTABLE TEXTILE(BLACK)/SHORT BAC	106337-99-0	<input type="radio"/>	235.00		
HEAD SUPPORT, ADJUSTABLE VINYL	106331-99-0	<input type="radio"/>	235.00		
HEAD SUPPORT, ADJUSTABLE VINYL/SHORT BACK	106338-99-0	<input type="radio"/>	235.00		
HEAD SUPPORT "ERGO" TEXTILE(BLACK)	106333-99-0	<input type="radio"/>	235.00		
HEAD SUPPORT "ERGO" TEXT. (BLACK) SHORT BACK	106335-99-0	<input type="radio"/>	235.00		
HEAD SUPPORT "ERGO"	106332-99-0	<input type="radio"/>	235.00		
HEAD SUPPORT "ERGO" SHORT BACK	106334-99-0	<input type="radio"/>	235.00		
BODILINK HEADREST L MAX 8 STD BACK	108719-99-0	<input type="radio"/>	491.00		106331-99-0 106336-99-0 106332-99-0 106333-99-0 106337-99-0 106338-99-0 106334-99-0 106335-99-0
BODILINK HEADREST L MAX 8 LOW BACK	108720-99-0	<input type="radio"/>	491.00		340x130mm Large 250x125mm Medium 180x110mm Small
BODILINK HEADREST M MAX 8 STD BACK	108717-99-0	<input type="radio"/>	491.00		
BODILINK HEADREST M MAX 8 LOW BACK	108718-99-0	<input type="radio"/>	491.00		
BODILINK HEADREST S MAX 8 STD BACK	109003-99-0	<input type="radio"/>	491.00		
BODILINK HEADREST S MAX 8 LOW BACK	109004-99-0	<input type="radio"/>	491.00		
HEADREST ORIGINAL 340x130 LONG HOLDER, STD BACK	107716-99-0	<input type="radio"/>	371.00		
HEADREST ORIGINAL 340x130 LONG HOLDER, SHORT BACK	107715-99-0	<input type="radio"/>	371.00		
HEADREST ORIGINAL 340x130 STD HOLDER, STD BACK	107718-99-0	<input type="radio"/>	371.00		
HEADREST ORIGINAL 340x130 STD HOLDER, SHORT BACK	107717-99-0	<input type="radio"/>	371.00		
HEADREST ORIGINAL 250x125 LONG HOLDER, STD BACK	107708-99-0	<input type="radio"/>	371.00		
HEADREST ORIGINAL 250x125 LONG HOLDER, SHORT BACK	107719-99-0	<input type="radio"/>	371.00		
HEADREST ORIGINAL 250x125 STD HOLDER, STD BACK	107710-99-0	<input type="radio"/>	371.00		
HEADREST ORIGINAL 250x125 STD HOLDER, SHORT BACK	107709-99-0	<input type="radio"/>	371.00		
HEADREST ORIGINAL 180x110 LONG HOLDER, STD BACK	107712-99-0	<input type="radio"/>	371.00		
HEADREST ORIGINAL 180x110 LONG HOLDER, SHORT BACK	107711-99-0	<input type="radio"/>	371.00		
HEADREST ORIGINAL 180x110 STD HOLDER, STD BACK	107714-99-0	<input type="radio"/>	371.00		
HEADREST ORIGINAL 180x110 STD HOLDER, SHORT BACK	107713-99-0	<input type="radio"/>	371.00		
<b>Facial support pad / switch Left</b>					
SWING AWAY FACIAL SUPPORT STANDARD LEFT/HIGH	107860-99-0	<input type="radio"/>	350.00		
SWING AWAY FACIAL SUPPORT LONG LEFT/HIGH	107861-99-0	<input type="radio"/>	350.00		
SWING AWAY ASSY W. EGG SW F. HEADREST LEFT/HIGH	107858-99-0	<input type="radio"/>	435.00		
SWING AWAY ASSY W. TASH MICRO LIGHT LEFT/HIGH	107859-99-0	<input type="radio"/>	597.00		
OPTION NOT REQUIRED		<input checked="" type="radio"/>			
<b>Facial support pad / switch Right</b>					
SWING AWAY FACIAL SUPPORT STANDARD RIGHT/HIGH	107941-99-0	<input type="radio"/>	350.00		
SWING AWAY FACIAL SUPPORT LONG RIGHT/HIGH	107944-99-0	<input type="radio"/>	350.00		
SWING AWAY ASSY W. EGG SW F. HEADREST RIGHT/HIGH	107931-99-0	<input type="radio"/>	435.00		
SWING AWAY ASSY W. TASH MICRO LIGHT RIGHT/HIGH	107935-99-0	<input type="radio"/>	597.00		
OPTION NOT REQUIRED		<input checked="" type="radio"/>			
<b>Extension cable</b>					
EXTENSION CABLE 3MM STEREO, L=1M	105931-99-0	<input type="radio"/>	52.00		
EXTENSION CABLE 3MM STEREO, L=2M	105932-99-0	<input type="radio"/>	52.00		
OPTION NOT REQUIRED		<input checked="" type="radio"/>			
<b>Lateral support</b>					
<b>Corpus</b>					
BODILINK LATERAL SUPP. L. STRETCH-AIR 75X140	109025-99-0	<input type="radio"/>	265.00		
BODILINK LATERAL SUPP. L. STRETCH-AIR 100X165	109027-99-0	<input type="radio"/>	265.00		
BODILINK LATERAL SUPP. R. STRETCH-AIR 75X140	109026-99-0	<input type="radio"/>	265.00		
BODILINK LATERAL SUPP. R. STRETCH-AIR 100X165	109028-99-0	<input type="radio"/>	265.00		
LATERAL SUPPORT ORIGINAL LEFT 180X130	107720-99-0	<input type="radio"/>	239.00		
LATERAL SUPPORT ORIGINAL LEFT 130X80	107722-99-0	<input type="radio"/>	239.00		
LATERAL SUPPORT ORIGINAL RIGHT 180X130	107721-99-0	<input type="radio"/>	239.00		
LATERAL SUPPORT ORIGINAL RIGHT 130X80	107723-99-0	<input type="radio"/>	239.00		
OPTION NOT REQUIRED		<input checked="" type="radio"/>			
					109025-99-0 109026-99-0 109027-99-0 109028-99-0 180x130mm 107720-99-0 107721-99-0 130x80mm 107722-99-0 107723-99-0

Thigh supports				
BODILINK THIGH SUPPORT L. STRETCH-AIR 90X110 S(B)	109179-99-0	<input type="radio"/>	207.00	
BODILINK THIGH SUPPORT L. STRETCH-AIR 200X90 L(C)	109181-99-0	<input type="radio"/>	207.00	
BODILINK THIGH SUPPORT L. STRETCH-AIR 300x90 XL(G)	109036-99-0	<input type="radio"/>	207.00	
BODILINK THIGH SUPPORT R. STRETCH-AIR 90X110 S(B)	109180-99-0	<input type="radio"/>	207.00	
BODILINK THIGH SUPPORT R. STRETCH-AIR 200X90 L(C)	109182-99-0	<input type="radio"/>	207.00	
BODILINK THIGH SUPPORT R. STRETCH-AIR 300x90 XL(G)	109037-99-0	<input type="radio"/>	207.00	
THIGH SUPPORT LEFT TEXTILE 110x90 SMALL (B)	107392-99-0	<input type="radio"/>	159.00	
THIGH SUPPORT LEFT TEXTILE 165x120 MEDIUM (J)	107396-99-0	<input type="radio"/>	159.00	
THIGH SUPPORT LEFT TEXTILE 200x90 LARGE (C)	107394-99-0	<input type="radio"/>	159.00	
THIGH SUPPORT LEFT TEXTILE 300x90 XLARGE (G)	107390-99-0	<input type="radio"/>	159.00	
THIGH SUPPORT RIGHT TEXTILE 110x90 SMALL (B)	107393-99-0	<input type="radio"/>	159.00	
THIGH SUPPORT RIGHT TEXTILE 165x120 MEDIUM (J)	107397-99-0	<input type="radio"/>	159.00	
THIGH SUPPORT RIGHT TEXTILE 200x90 LARGE (C)	107395-99-0	<input type="radio"/>	159.00	
THIGH SUPPORT RIGHT TEXTILE 300x90 XLARGE (G)	107391-99-0	<input type="radio"/>	159.00	
OPTION NOT REQUIRED		<input type="checkbox"/>		
Hip supports				
BODILINK HIP SUPPORT L. STRETCH-AIR 90X110 S(B)	109032-99-0	<input type="radio"/>	207.00	
BODILINK HIP SUPPORT L. STRETCH-AIR 200X90 L(C)	109034-99-0	<input type="radio"/>	207.00	
BODILINK HIP SUPPORT L. STRETCH-AIR 150X140 M(A)	109038-99-0	<input type="radio"/>	207.00	
BODILINK HIP SUPPORT R. STRETCH-AIR 90X110 S(B)	109033-99-0	<input type="radio"/>	207.00	
BODILINK HIP SUPPORT R. STRETCH-AIR 200X90 L(C)	109035-99-0	<input type="radio"/>	207.00	
BODILINK HIP SUPPORT R. STRETCH-AIR 150X140 M(A)	109039-99-0	<input type="radio"/>	207.00	
HIP SUPPORT LEFT TEXTILE 110x90 SMALL (B)	107400-99-0	<input type="radio"/>	159.00	
HIP SUPPORT LEFT TEXTILE 150x140 MEDIUM (A)	107398-99-0	<input type="radio"/>	159.00	
HIP SUPPORT LEFT TEXTILE 200x90 LARGE (C)	107402-99-0	<input type="radio"/>	159.00	
HIP SUPPORT LEFT TEXTILE 200x200 XLARGE (D)	107404-99-0	<input type="radio"/>	159.00	
HIP SUPPORT RIGHT TEXTILE 110x90 SMALL (B)	107401-99-0	<input type="radio"/>	159.00	
HIP SUPPORT RIGHT TEXTILE 150x140 MEDIUM (A)	107399-99-0	<input type="radio"/>	159.00	
HIP SUPPORT RIGHT TEXTILE 200x90 LARGE (C)	107403-99-0	<input type="radio"/>	159.00	
HIP SUPPORT RIGHT TEXTILE 200x200 XLARGE (D)	107405-99-0	<input type="radio"/>	159.00	
OPTION NOT REQUIRED		<input type="checkbox"/>		
Calf supports				
CALF SUPPORTS S (B) 110x90 TEXT.	105252-99-0	<input type="radio"/>	254.00	
CALF SUPPORTS M (J) 165x120 TEXT.	105258-99-0	<input type="radio"/>	254.00	
CALF SUPPORTS L (A) 150x140 TEXT.	105250-99-0	<input type="radio"/>	254.00	
CALF SUPPORTS XL (H) 170x175 TEXT.	105256-99-0	<input type="radio"/>	254.00	
CALF SUPPORTS XXL (D) 200x200 TEXT.	105254-99-0	<input type="radio"/>	254.00	
CALF SUPPORTS S (B) 110x90 TEXT. (VS)	107210-99-0	<input type="radio"/>	254.00	
CALF SUPPORTS M (J) 165x120 TEXT. (VS)	107211-99-0	<input type="radio"/>	254.00	
CALF SUPPORTS L (A) 150x140 TEXT. (VS)	106190-99-0	<input type="radio"/>	254.00	
CALF SUPPORTS XL (H) 170x175 TEXT. (VS)	106188-99-0	<input type="radio"/>	254.00	
CALF SUPPORTS XXL (D) 200x200 TEXT. (VS)	106186-99-0	<input type="radio"/>	254.00	
OPTION NOT REQUIRED		<input type="checkbox"/>		
Elbow and side supports armrests				
ELBOW SUPPORT LEFT	107838-99-0	<input type="checkbox"/>	95.00	
ELBOW SUPPORT RIGHT	107839-99-0	<input type="checkbox"/>	95.00	
ARMREST SIDE SUPPORT LEFT OUTSIDE	107863-99-0	<input type="checkbox"/>	53.00	
ARMREST SIDE SUPPORT RIGHT OUTSIDE	107840-99-0	<input type="checkbox"/>	53.00	
ARMREST SIDE SUPPORT LEFT INSIDE	107865-99-0	<input type="checkbox"/>	53.00	
ARMREST SIDE SUPPORT RIGHT INSIDE	107864-99-0	<input type="checkbox"/>	53.00	
Gel pads footpates				
STEALTH GEL PADS 16CM WIDE FOOTPATES	106530-99-0	<input type="checkbox"/>	313.00	
STEALTH GEL PADS 20CM WIDE FOOTPATES	106225-99-0	<input type="checkbox"/>	313.00	
Abduction wedge				
ABDUCTION WEDGE	109373-99-0	<input type="checkbox"/>	307.00	

Shoulder support				
SHOULDER SUPPORT FOR 36CM WIDE BACKREST	105410-99-0	<input type="radio"/>	0.00	 <p>36cm 105410-99-0 41cm 105411-99-0 46cm 105412-99-0 51cm 105854-99-0</p>
SHOULDER SUPPORT FOR 41CM WIDE BACKREST	105411-99-0	<input type="radio"/>	0.00	
SHOULDER SUPPORT FOR 46CM WIDE BACKREST	105412-99-0	<input type="radio"/>	0.00	
SHOULDER SUPPORT FOR 51CM WIDE BACKREST	105854-99-0	<input type="radio"/>	0.00	
OPTION NOT REQUIRED		<input checked="" type="radio"/>		
Stump supports				
STUMP SUPPORT SMALL (A) 150x140 TEXTILE (MESH)	106497-99-0	<input type="radio"/>	191.00	 <p>A: 150x140mm 103067-99-0 J: 165x120mm 103068-99-0 D: 200x200mm 103071-99-0 H: 170x175mm 103073-99-0</p>
STUMP SUPPORT MEDIUM (J) 165x120 TEXTILE (MESH)	106500-99-0	<input type="radio"/>	191.00	
STUMP SUPPORT LARGE (H) 170x175 TEXTILE (MESH)	106499-99-0	<input type="radio"/>	191.00	
STUMP SUPPORT XLARGE (D) 200x200 TEXTILE (MESH)	106498-99-0	<input type="radio"/>	191.00	
OPTION NOT REQUIRED		<input checked="" type="radio"/>		
Knee support				
KNEE SUPPORTS SWING AWAY LARGE (CORPUS/130*330MI)	110452-99-0	<input type="radio"/>	250.00	 <p>110452-99-0 110453-99-0 107285-99-0 107028-99-0</p>
KNEE SUPPORTS SWING AWAY SMALL (CORPUS/114*316M)	110453-99-0	<input type="radio"/>	250.00	
KNEE SUPPORT WITH TEXTIEL UPHOLSTERY	107285-99-0	<input type="radio"/>	0.00	
HOLDER KNEE SUPPORT UNITRACK	107028-99-0	<input type="checkbox"/>	45.00	
Lumbar support				
LUMBAR SUPPORT,AIR	101972-99-0	<input type="checkbox"/>	191.00	
Seatbelts				
CHEST STRAP BODYPOINT ELASTIC LARGE	105843-99-0	<input type="radio"/>	80.00	 <p>105845-99-0 105843-99-0</p>
CHEST STRAP BODYPOINT ELASTIC SMALL	105845-99-0	<input type="radio"/>	80.00	
OPTION NOT REQUIRED		<input checked="" type="radio"/>		
SEATBELT, BODYPOINT 2- POINT, MEDIUM, NON-PADDED	104518-99-0	<input type="radio"/>	72.00	 <p>Hip belts non padded Hip belts padded Rehab Latch Hip belts padded 4-Point R pull 100518-99-0 100519-99-0 100600-99-0 100529-99-0 100519-99-0 100600-99-0</p> <p>Monoflex™ Chest Support PivotFit™ Shoulder Harness Stayflex™ Chest Support 100529-99-0</p>
SEATBELT, BODYPOINT 2- POINT, LARGE, NON-PADDED	104514-99-0	<input type="radio"/>	72.00	
SEATBELT, BODYPOINT 2- POINT, MEDIUM, PADDED	104520-99-0	<input type="radio"/>	103.00	
SEATBELT, BODYPOINT 2- POINT, LARGE, PADDED	104516-99-0	<input type="radio"/>	103.00	
SEATBELT, BODYPOINT 2- POINT, X-LARGE, PADDED	106531-99-0	<input type="radio"/>	103.00	
BP HIP BELT, 2P C PULL LATCH 46CM PAD	108267-99-0	<input type="radio"/>	103.00	
BP HIP BELT, 2P C PULL LATCH 62CM PAD	108266-99-0	<input type="radio"/>	103.00	
BP HIP BELT, 4P R PULL PUSHBUTT. 46CM PAD	108265-99-0	<input type="radio"/>	139.00	
SAFETY BELT,BUCKLE	100518-99-0	<input type="radio"/>	60.00	
SAFETY BELT,AUTOTENSION	100519-99-0	<input type="radio"/>	114.00	
SAFETY BELT,AUTOTENSION LONG VERSION	100600-99-0	<input type="radio"/>	114.00	
OPTION NOT REQUIRED		<input checked="" type="radio"/>		
SAFETY BELT,4-POINT	100529-99-0	<input type="radio"/>	145.00	
SEATBELT, BODYPOINT MONOFLEX MEDIUM	105840-99-0	<input type="radio"/>	87.00	
SEATBELT, BODYPOINT MONOFLEX LARGE	105839-99-0	<input type="radio"/>	87.00	
SEATBELT, BODYPOINT MONOFLEX X-LARGE	105850-99-0	<input type="radio"/>	87.00	
BP HARNESS PIVOTFIT S SHOULDER SUPPORT FP	108275-99-0	<input type="radio"/>	154.00	
BP HARNESS PIVOTFIT M SHOULDER SUPPORT FP	108276-99-0	<input type="radio"/>	154.00	
BP HARNESS PIVOTFIT L SHOULDER SUPPORT FP	108277-99-0	<input type="radio"/>	154.00	
BP HARNESS PIVOTFIT XL SHOULDER SUPPORT FP	108278-99-0	<input type="radio"/>	154.00	
BP HARNESS STAYFLEX XS CHEST SUPPORT FP	108269-99-0	<input type="radio"/>	154.00	
BP HARNESS STAYFLEX S CHEST SUPPORT FP	108270-99-0	<input type="radio"/>	154.00	
BP HARNESS STAYFLEX M CHEST SUPPORT FP	108271-99-0	<input type="radio"/>	154.00	
BP HARNESS STAYFLEX L CHEST SUPPORT FP	108272-99-0	<input type="radio"/>	154.00	
BP HARNESS STAYFLEX XL CHEST SUPPORT FP	108273-99-0	<input type="radio"/>	154.00	
OPTION NOT REQUIRED		<input checked="" type="radio"/>		
FOOTSTRAPS WITH PADS (SET OF 2)	103104-99-0	<input type="radio"/>	127.00	 <p>103104-99-0 103427-99-0 108242-99-0 108243-99-0</p>
FOOTSTRAPS WITHOUT PADS (SET OF 2)	103427-99-0	<input type="radio"/>	42.00	
BP ANKEL HUGGERS MEDIUM	108242-99-0	<input type="radio"/>	147.00	
BP ANKEL HUGGERS LARGE	108243-99-0	<input type="radio"/>	147.00	
OPTION NOT REQUIRED		<input checked="" type="radio"/>		
Alternative seat cushions / options				
INCONTINENCE PROTECTIVE COVER	0	<input type="checkbox"/>	140.00	
SEAT CUSHION ERGO AIR		<input type="checkbox"/>	583.00	
ROHO QUADRO SELECT (Prices starting from)		<input type="checkbox"/>	674.00	
ROHO CONTOUR (Prices starting from)		<input type="checkbox"/>	674.00	
ROHO HYBRID ELITE (Prices starting from)		<input type="checkbox"/>	580.00	



Tray tables				
TABLE,SWING AWAY 550MM FOR JOYSTICK L/R	109325-99-0	<input type="radio"/>	<input type="radio"/>	371.00
TABLE,SWING AWAY 600MM FOR JOYSTICK L/R	105262-99-0	<input type="radio"/>	<input type="radio"/>	371.00
TABLE,SWING AWAY 650MM FOR JOYSTICK L/R	105263-99-0	<input type="radio"/>	<input type="radio"/>	371.00
OPTION NOT REQUIRED		<input checked="" type="checkbox"/>		
TABLE.REMOVABLE ANGLE ADJ LEFT, WIDTH 330MM	108510-99-0	<input type="radio"/>		318.00
TABLE.REMOVABLE ANGLE ADJ RIGHT, WIDTH 330MM	108505-99-0		<input type="radio"/>	318.00
TABLE.REMOVABLE ANGLE ADJ LEFT, WIDTH 380MM	108511-99-0	<input type="radio"/>		318.00
TABLE.REMOVABLE ANGLE ADJ RIGHT, WIDTH 380MM	108506-99-0		<input type="radio"/>	318.00
TABLE.REMOVABLE ANGLE ADJ LEFT, WIDTH 430MM	108512-99-0	<input type="radio"/>		318.00
TABLE.REMOVABLE ANGLE ADJ RIGHT, WIDTH 430MM	108507-99-0		<input type="radio"/>	318.00
TABLE.REMOVABLE ANGLE ADJ LEFT, WIDTH 480MM	108513-99-0	<input type="radio"/>		318.00
TABLE.REMOVABLE ANGLE ADJ RIGHT, WIDTH 480MM	108508-99-0		<input type="radio"/>	318.00
TABLE.ANGLE ADJUST. 1-SIDE FIXATION	106863-99-0		<input type="radio"/>	371.00
OPTION NOT REQUIRED		<input checked="" type="checkbox"/>		
BRACKET ADDITIONAL POSITION TABLE	107295-99-0		<input type="checkbox"/>	0.00
COLLEGE TABLE.LEFT	105686-99-0	<input type="radio"/>		233.00
COLLEGE TABLE RIGHT	105831-99-0		<input type="radio"/>	233.00
OPTION NOT REQUIRED		<input checked="" type="checkbox"/>		
Pouches/Bags				
ARMREST POUCH,RIGHT BLACK	107339-99-0		<input type="checkbox"/>	39.00
ARMREST POUCH,LEFT BLACK	107338-99-0	<input type="checkbox"/>		39.00
SEATFRAME POUCH BLACK	107340-99-0		<input type="checkbox"/>	39.00
BACK PACK	102059-99-0		<input type="checkbox"/>	159.00
BACKPACK HOOKS,SET UNITRACK	105563-99-0	<input type="radio"/>		30.00
BACKPACK HOOK BACKREST PROFILE HIGH	109186-99-0	<input type="radio"/>		30.00
BACKPACK HOOK BACKREST PROFILE LOW	109187-99-0	<input type="radio"/>		30.00
OPTION NOT REQUIRED		<input checked="" type="checkbox"/>		
POSITION LEFT BACKPACK HOOK ONLY	109189-99-0	<input type="radio"/>		0.00
POSITION RIGHT BACKPACK HOOK ONLY	109188-99-0		<input type="radio"/>	0.00
Other				
SUPPORT HANDLE ARMREST	106058-99-0	<input type="radio"/>	<input type="radio"/>	117.00
OPTION NOT REQUIRED		<input checked="" type="checkbox"/>		
TRANSFER HANDLES, SET	105260-99-0		<input type="checkbox"/>	186.00
PUSH HANDLES	105292-99-0	<input type="radio"/>		172.00
PUSH HANDLES (BACKREST 360)	105795-99-0	<input type="radio"/>		172.00
OPTION NOT REQUIRED		<input checked="" type="checkbox"/>		
CRUTCH HOLDER	105223-99-0	<input type="radio"/>	<input type="radio"/>	180.00
OPTION NOT REQUIRED		<input checked="" type="checkbox"/>		
HOLDER OXYGEN BOTTLE C3G	105224-99-0		<input type="checkbox"/>	207.00
CUP HOLDER	106210-99-0		<input type="checkbox"/>	27.00
PHONE HOLDER X-GRIP	106806-99-0		<input type="checkbox"/>	76.00
TABLET HOLDER X-GRIP	106972-99-0		<input type="checkbox"/>	131.00
Controls				
User control				
JOYSTICK R-NET HS WITH 3.5" COLOR DISPLAY	108848-99-0	<input checked="" type="checkbox"/>		519.00
JOYSTICK R-NET "EL" LED	105246-99-0	<input type="radio"/>		0.00
JOYSTICK R-NET HEAVY DUTY WITH COLOUR DISPLAY	105700-99-0	<input type="radio"/>		1039.00
NON STANDARD STEERING (SEE SPECIAL CONTROLS)	101352-99-0	<input type="radio"/>		0.00
Parameters Joystick menu				
INDEPENDENT REPOSITIONING MODE (IRM)	110156-99-0		<input type="checkbox"/>	0.00
PROGR.SET: MEM RECALL VIA JS SEAT MENU OFF	109800-99-0		<input type="checkbox"/>	0.00
PROGR.SET: MEM SAVE VIA JS SEAT MENU OFF	109801-99-0		<input type="checkbox"/>	0.00
PROGR.SET: SEAT FUNCTIONS VIA JS SEAT MENU OFF	109802-99-0		<input type="checkbox"/>	0.00

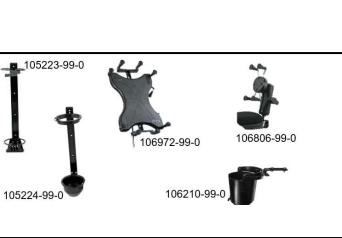
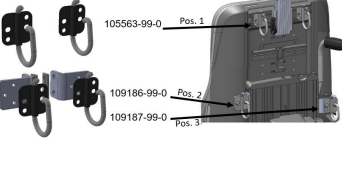
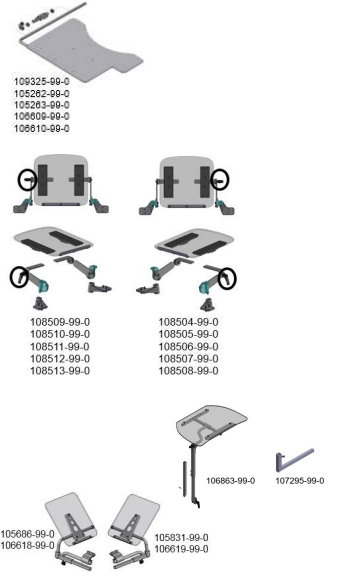



Joystick holder			
PANELHOLDER PARALLEL MOTION UNITRACK	107754-99-0	<input checked="" type="radio"/>	180.00
PANELHOLDER SWING AWAY L=335MM	103473-99-0	<input type="radio"/>	0.00
PANELHOLDER SWING AWAY L=435MM	103474-99-0	<input type="radio"/>	0.00
BODYPOINT MIDLINE MOUNT ASSEMBLY KIT R-NET	108019-99-0	<input type="radio"/>	541.00
PANEL HOLDER ATTENDANT LONG	107788-99-0	<input type="radio"/>	244.00
WITHOUT PANELHOLDER	102835-99-0	<input type="radio"/>	0.00
Height adjustable holder			
HEIGHT ADJUSTABLE RIGHT JOYSTICK HOLDER	107960-99-0	<input type="radio"/>	133.00
HEIGHT ADJUSTABLE LEFT JOYSTICK HOLDER	107963-99-0	<input type="radio"/>	133.00
HEIGHT ADJUSTABLE JOYSTICK HOLDER	108005-99-0	<input type="radio"/>	133.00
Switch box			
SWITCH BOX WITH TOGGLE SWITCHES	102799-99-0	<input type="radio"/>	625.00
SWITCH BOX WITH PUSH BUTTONS	102798-99-0	<input type="radio"/>	625.00
WITHOUT SWITCH BOX	104621-99-0	<input checked="" type="radio"/>	0.00
Bracket switch box			
BRACKET SWITCH BOX JOYSTICK	103469-99-0	<input checked="" type="radio"/>	0.00
BRACKET SWITCH BOX UNITRACK ARMREST	104651-99-0	<input type="radio"/>	42.00
BRACKET SWITCH BOX BACKREST	106256-99-0	<input type="radio"/>	42.00
OPTION NOT REQUIRED	105409-99-0	<input type="radio"/>	0.00
Layout switch box			
SWITCHBOX(1) LAYOUT "A": SINGLE LAYER (STD)	108794-99-0	<input checked="" type="radio"/>	0.00
SWITCHBOX(1) LAYOUT "B": SINGLE LAYER, MEM	108795-99-0	<input type="radio"/>	0.00
SWITCHBOX(1) LAYOUT "C": SWAP LAYERS, MEM	108796-99-0	<input type="radio"/>	0.00
SWITCHBOX(1) LAYOUT "D": SINGLE LAYER (ALT SEQ)	108797-99-0	<input type="radio"/>	0.00
SWITCHBOX(1) LAYOUT "E": SINGLE LAYER, NO TILT	108798-99-0	<input type="radio"/>	0.00
SWITCHBOX(1) LAYOUT "F": SINGLE STAND, SWAP, MEM	108799-99-0	<input type="radio"/>	0.00
SWITCHBOX(1) LAYOUT "L": SWAP, MEM, 5 OPTIONS	108801-99-0	<input type="radio"/>	0.00
Indication level switch box			
SWITCHBOX(1) IND. LEVEL 1: NONE	108802-99-0	<input type="radio"/>	0.00
SWITCHBOX(1) IND. LEVEL 2: SEAT FUNCTION	108803-99-0	<input type="radio"/>	0.00
SWITCHBOX(1) IND. LEVEL 3: SPEED LIMITATION	108804-99-0	<input type="radio"/>	0.00
SWITCHBOX(1) IND. LEVEL 4: COMPLETE	108805-99-0	<input checked="" type="radio"/>	0.00
External charging socket (required with table- or special control)			
EXTRA CHARGER CONNECTOR MOUNTED ON THE ARMRES	104163-99-0	<input type="radio"/>	117.00
EXTRA CHARGER CONNECTOR MOUNTED ON ACC. RAIL	104164-99-0	<input type="radio"/>	117.00
EXTRA CHARGER CONNECTOR MOUNTED UNDER SEAT FR	104165-99-0	<input type="radio"/>	117.00
OPTION NOT REQUIRED	105409-99-0	<input checked="" type="radio"/>	0.00
Lock Key			
LOCKING KEY R-NET	104620-99-0	<input type="checkbox"/>	35.00
Alternative Joystick knobs			
JOYSTICK KNOB CHIN CUP	100960-99-0	<input type="radio"/>	37.00
JOYSTICK KNOB T-GRIP	100961-99-0	<input type="radio"/>	37.00
JOYSTICK KNOB BALL BIG	100962-99-0	<input type="radio"/>	37.00
JOYSTICK KNOB SOFT BALL	100963-99-0	<input type="radio"/>	37.00
JOYSTICK KNOB MUSHROOM	100964-99-0	<input type="radio"/>	37.00
JOYSTICK KNOB STICK	100965-99-0	<input type="radio"/>	37.00
JOYSTICK KNOB BALL SMALL	101165-99-0	<input type="radio"/>	37.00
JOYSTICK KNOB STANDARD	101166-99-0	<input type="radio"/>	37.00
JOYSTICK KNOB SOFT BALL BLACK (CONE)	105442-99-0	<input type="radio"/>	37.00
JOYSTICK KNOB BODYPOINT 7.5CM U-SHAPED	105846-99-0	<input type="radio"/>	59.00
JOYSTICK KNOB BODYPOINT 10CM U-SHAPED	105847-99-0	<input type="radio"/>	59.00
JOYSTICK KNOB BODYPOINT RUBBER DOME	105848-99-0	<input type="radio"/>	54.00
OPTION NOT REQUIRED	105409-99-0	<input checked="" type="radio"/>	0.00

Attendant control			
JOYSTICK ATTENDANT RNET SPEED/MODE	107321-99-0	<input type="radio"/>	519.00
SCOOT CONTROL R-NET	109532-99-0	<input type="radio"/>	2433.00
CO-PILOT	105225-99-0	<input type="radio"/>	2100.00
OPTION NOT REQUIRED		<input checked="" type="radio"/>	0.00
Emergency switch			
EMERGENCY STOP SWITCH POWER PLATFORM	110287-99-0	<input type="checkbox"/>	207.00
Supplementary accessories			
(Mounting costs can apply)			
MDT/RNET: JS COMPACT (LOW FORCE)	103892-99-0	<input type="radio"/>	1431.00
MDT/RNET: JS COMPACT	103817-99-0	<input type="radio"/>	901.00
MDT/RNET: MINI JOYSTICK	105289-99-0	<input type="radio"/>	2173.00
MICRO JOYSTICK R-NET, W. 300MM RNET CABLE	109524-99-0	<input type="radio"/>	2173.00
MULTI JOYSTICK R-NET, W. 300MM RNET CABLE	109526-99-0	<input type="radio"/>	1961.00
ALL-ROUND JOYSTICK LIGHT RNET W. 300MM RNET CABLE	109528-99-0	<input type="radio"/>	1643.00
ALL-ROUND JOYSTICK R-NET, W. 300MM RNET CABLE	109530-99-0	<input type="radio"/>	1049.00
OPTION NOT REQUIRED		<input checked="" type="radio"/>	
PANEL HOLDER ATTENDANT	105210-99-0	<input type="checkbox"/>	244.00
CHEST SUPPORT FOR TABLE CII/VII VINYL	101303-99-0	<input type="checkbox"/>	181.00
USB OUTLET CABLE	108995-99-0	<input type="radio"/>	143.00
OPTION NOT REQUIRED		<input checked="" type="radio"/>	
SWITCH KIT FOR COMPACT JS (CHIN)	104641-99-0	<input type="checkbox"/>	339.00
BUDDY BUTTON BLACK 63 MM	101766-99-0	<input type="radio"/>	103.00
BUDDY BUTTON RED 63 MM	101767-99-0	<input type="radio"/>	103.00
BUDDY BUTTON YELLOW 63 MM	101768-99-0	<input type="radio"/>	103.00
MICRO LIGHT SWITCH	101769-99-0	<input type="radio"/>	162.00
MINI CUP SWITCH 24 MM	101771-99-0	<input type="radio"/>	162.00
GRASP SWITCH	101772-99-0	<input type="radio"/>	235.00
SATELLITE TWISTER, BLACK CABLE 30CM	109546-99-0	<input type="radio"/>	189.00
SATELLITE TWISTER, RED CABLE 30CM	109547-99-0	<input type="radio"/>	189.00
SATELLITE TWISTER, YELLOW CABLE 30CM	109548-99-0	<input type="radio"/>	189.00
SATELLITE TWISTER, BLUE CABLE 30CM	109549-99-0	<input type="radio"/>	189.00
SATELLITE TWISTER, GREEN CABLE 30CM	109550-99-0	<input type="radio"/>	189.00
CONNECTION BOX EXTERNAL SWITCHES SEATING	104196-99-0	<input type="checkbox"/>	625.00
CONNECTION BOX EXTERNAL SWITCHES R-NET (RBI)	104696-99-0	<input type="checkbox"/>	661.00
HAND WARMER SET	109533-99-0	<input type="checkbox"/>	636.00
CONE 1 HAND HAND HEATER	107363-99-0	<input type="radio"/>	170.00
CONE 2 HANDS HAND HEATER	107364-99-0	<input type="radio"/>	260.00
OPTION NOT REQUIRED		<input checked="" type="radio"/>	

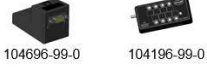

**User consent for the installation of ConnectMe**

Please select one of the below options:

I consent to the installation of the ConnectMe hardware at the time of manufacture. I understand this to mean that the ConnectMe hardware will be installed and ready to activate at the time of my receipt of the wheelchair and, once activated, will include the ability to monitor how my wheelchair is functioning while active, including the use of location data. I may withdraw my consent at any time by contacting my provider or Permobil directly.

I give my consent to Permobil to contact me regarding the activation of my wheelchair for the purpose of providing support with the activation process.

Name:

Email:

Phone (optional):

Signature:

**Notes**