

Owner's manual

English

K300/C300/C300s

CE

Dear Permobil Owner

We congratulate you on your choice of power wheelchair. Our goal is for you to continue to feel satisfied with your choice of both vendor and wheelchair. Your Permobil is designed to give you highest possible comfort and safety and to meet the requirements regarding safety and environment.

Before you begin using your wheelchair, it is important that you read and understand the content of these operating instructions and in particular the Safety Instructions.

Produced and published by Permobil AB

Edition: 2, 2014-06

Order no: 205266-UK-0

Where to find Permobil

Permobil Europe @X"

Office 312 Britannia Office Quarter Waters Meeting Britannia Way
BL1 8SW

Bolton, United Kingdom

Tel: (+44) (0)1484 722 888

Fax: (+44) (0)1484 723 013

Email: info@permobil.uk

The Permobil Group's Head Office

Permobil AB

Box 120

861 23 Timrå

Sverige

Tel: 060-59 59 00

Fax: 060-57 52 50

E-Mail: info@permobil.com

CONTENTS

Important Information about this Owner's Manual	9
Safety instructions	13
Design & Function.....	33
R-net Control Panel With LCD Color Display	41
R-net Control Panel With LCD Monochrome Display.....	53
R-net LED Control Panel	69
VR2 CONTROL PANEL.....	79
Handling	89
Transport.....	105
Maintenance and repairs	111
Accessories	127
Technical Specifications.....	129
Troubleshooting	133
Stickers.....	151
Index	156

IMPORTANT INFORMATION ABOUT THIS OWNER'S MANUAL

Before you begin using your wheelchair, it is important that you read and understand the content of these operating instructions and in particular the Safety Instructions.

These operating instructions are primarily intended to acquaint you with the functions and characteristics of the wheelchair and how you can use them in the best manner possible. They also contain important safety and maintenance information, as well as describing possible problems that can arise while driving the wheelchair.

Always keep these operating instructions handy in connection with your wheelchair, since the need for important information can arise concerning its use, safety and maintenance.

It is also possible to obtain information concerning our products from our home page on the Internet. You can find us at www.permobil.com.

All information, pictures, illustrations and specifications are based upon the product information that was available at the time that these operating instructions were printed. Pictures and illustrations that are found in these operating instructions are representative examples and not intended to be exact depictions of the various parts of the wheelchair.

We reserve the right to make changes to the product without prior notice.

If you are visually impaired, this document can be viewed in PDF format at www.permobil.com or alternatively ordered in large text.

Technical support

In the event of technical problems, you should contact Permobil.

Always state the seats serial number when contacting Permobil to ensure that the correct information is provided.

Spare parts & accessories

Spare parts and accessories must be ordered through Permobil. The expected service life of this product is 7 years.

Scrapping

Contact Permobil for information about scrapping agreements in force.

Warranty

All wheelchairs are supplied with a two-year product guarantee. Batteries and charger are supplied with one year warranty.

Incident reporting

If an incident occurs please contact your nearest Permobil representative. Normally the same person you contacted at purchase day. To prepare this contact there is a link on our homepage, on the internet, at www.permobil.com. Open up your country page and the contact page. Here is the needed contact information and a guidance document in what information we need to investigate the incident. Complete the information as much as possible. This is of great help for us.

To increase the product quality and to ensure that our product is safe through the whole life cycle we need you to send in Incident Reports. It is also stated in MEDDEV 2.12-1 and Annex 9 that the manufacturer shall *“Encourage users or those given specific responsibility for reporting incidents that have occurred with medical devices and that meet the criteria within these guidelines to report the incidents to the Manufacturer and or to the Competent Authority in accordance with national guidance”*.

To meet the requirements and to ensure that our products shall remain safe in your hands we need your assistance. We hope you never need to use the information on this page but if there is an incident please contact us.

Product approval

This product fulfil the requirements according to EN 12184, EN 1021-1, EN 1021-2, ISO 7176-9:2009, ISO 7176-14:2008, ISO 7176-16:1997 and ISO 7176-19:2001.

SAFETY INSTRUCTIONS

General

An electric wheelchair is a motorized vehicle and special care must therefore be taken when it is used. Please read and follow all instructions and warnings in this manual before operating your Permobil powered wheelchair. Incorrect use may both injure the user and damage the chair. In order to reduce these risks, you should read the Owner's Manual carefully, in particular the safety instructions and their warning texts.

Permobil is not responsible for personal injuries or property damage resulting from any person's failure to follow the warnings and instructions in this manual. Permobil is not responsible for injuries or damage resulting from failure to exercise good judgment.

The final selection and purchasing decision about the type of electric wheelchair to be used is the responsibility of the wheelchair user and his or her healthcare professional. Permobil Inc. is not responsible for inappropriate selections of wheelchair models or features or improper fitting of the wheelchair.

Attention!

Throughout this manual the following symbol will be used to note items that have significant importance to safety concerns:

WARNING!

Please use extreme caution where this warning symbol appears. Failure to observe warnings can lead to personal injury and property damage, including damage to the wheelchair.

CAUTION!

Please use caution where this symbol appears.

Your wheelchair and seat was configured specifically for your needs as prescribed by your healthcare provider. Consult your healthcare provider before changing the seat position or making any other adjustment. Some adjustments may reduce your wheelchair's performance or safety or may not be appropriate for your needs.

It is also of the utmost importance that you devote sufficient time to become acquainted with the different buttons, the function and steering controls, the different adjustment possibilities of the seat, etc. of your wheelchair and its accessories before you begin using it.

Do not undertake your own first test drive without making sure that you have assistance in the immediate vicinity if you should need help.

Prepare for use

In order to make sure that nothing happened to the wheelchair while it was being shipped to you, you should check the following items before beginning to use it:

- that all products ordered are included in the delivery, including operating instructions and possible other documentation. If you suspect that something is missing, then contact your supplier or Permobil for more information as soon as possible.
- that no transport-related or other damages have occurred to the wheelchair, seat and its accessories. If you discover that something has been damaged or in some other manner appears to be incorrect, then contact your supplier or Permobil for more information as soon as possible before you continue the checks.

We recommend that you charge your wheelchair's batteries before you begin using it. The chapter titled "Charging the Batteries" describes how to do this.

Always be sure that tires are inflated properly before driving.

If you experience that the wheelchair in any manner is not behaving as expected or if you suspect that something is wrong: abort the test drive as soon as possible, shut off the wheelchair and get in touch with your service contact or Permobil for more information.

Warnings and precautions

CAUTION!

Operation

Permobil recommends the use of wheelchair lights at all times user is riding near public rights of way. Use extreme caution when driving near unprotected ledges, drop-offs or on elevated surfaces. Unintended movement or excessive speed in these areas can lead to personal injury or property damage.

CAUTION!

Operation

Do not drive the wheelchair over any curbs or edges higher than indicated in the technical specifications section of the manual. When driving over a curb or similarly elevated surface, you must cross the surface at a 90 degree angle (perpendicular). Crossing such surfaces at any other angle may result in the wheelchair tipping.

Reduce your speed when driving on uneven terrain or soft surfaces. Do not use your wheelchair on stairs or escalators. Always use an elevator.

Do not lift or move the wheelchair by any of its removable parts. Doing so could lead to personal injury and property damage, including damage to the wheelchair.

 CAUTION!**Operation**

Do not let children drive the wheelchair without supervision. Do not drive the wheelchair on public streets or roadways. Obey all local pedestrian rules and be aware that vehicle drivers may have difficulty seeing you. Do not operate your wheelchair under the influence of alcohol. Consumption of alcohol may impair your ability to operate your wheelchair safely.

Some physical limitations or use of medication, either prescribed or over-the-counter, may limit your ability to operate your wheelchair safely. Be sure to consult with your physician about your physical limitations and medications.

 CAUTION!**Operation**

Do not use the wheelchair to pull any kind of objects and never hang excessive weights on the backrest. Doing so could lead to personal injury and property damage, including damage to the wheelchair.

If you by accident impact with walls - doors, or other fixed objects when operating the wheelchair, always make sure all parts of the wheelchair are undamaged before operating the wheelchair again. Not doing so could lead to personal injury.

 WARNING!**Modifications**

Any unauthorized modifications to the wheelchair or its various systems may increase the risk of personal injury and property damage, including damage to the wheelchair.

All modifications to and interventions in the vital systems of the wheelchair must be performed by a qualified service technician authorized by Permobil to perform such service on Permobil products.

 WARNING!**Weight Limitations**

The maximum user weight for your Permobil is set forth in the specification section in this Owner's Manual for current seat model. Operation of the wheelchair by users who exceed the maximum allowable user weight can lead to personal injury and property damage, including damage to the wheelchair, as well as voiding any applicable warranty to the wheelchair.

Do not carry passengers on the wheelchair. Doing so can lead to personal injury and property damage, including damage to the wheelchair.

 CAUTION!**Prior to Riding**

In some instances, including where certain medical conditions exist, users should practice operating their wheelchair under the supervision of an assistant who is familiar with the operation of the wheelchair and with the abilities and limitations of the user.

 CAUTION!**Operation - Inclines**

When driving downhill, select the slowest speed and proceed with caution. Driving down an incline can shift the user's center of gravity forward. If the wheelchair rolls faster than you would like, stop the wheelchair by releasing the joystick and begin descending again at a slower speed.

Avoid sudden stops or starts. Stop by releasing joystick rather than by turning the power off. Turning off power while the wheelchair is in motion will cause the wheelchair to stop suddenly. Be sure to keep all recommended positioning belts securely fastened at all times.

When driving up an incline, try to keep moving at a steady speed. Stopping and starting the chair while moving up an incline makes the wheelchair more difficult to control.

Do not drive up or down slopes with a gradient greater than indicated in the technical specifications section of the manual. There is a risk that the wheelchair will not maneuver safely.

 WARNING!**Operation - Inclines**

Do not drive the wheelchair where the sideways gradient is more than indicated in the technical specifications section of the manual. There is a risk of tipping over.

Do not drive up or down ramps that are not equipped with proper edge protection along the sides of the ramp to prevent the wheelchair from falling off of the ramp.

When driving up an incline, be sure to drive your wheelchair straight up the incline (perpendicular). Driving at an angle up an incline increases the risk of tipping or falling. Use extreme caution when driving up an incline.

Do not drive down or up a hazardous incline, such as a surface covered with snow, ice, or wet leaves or a surface that is uneven. Also avoid driving on ramps that do not have proper edge protection.

 WARNING!**Operation - Turning**

Turning your wheelchair at high speeds can create the possibility of the wheelchair tipping and personal injury. The possibility of tipping can be increased by high turning speed, sharp turns, uneven surfaces, abrupt changes in direction, and driving from an area of low traction (e.g. lawn) to an area of high traction (e.g. sidewalk). To protect against tipping, personal injury and property damage, reduce speed and reduce the sharpness of your turn when turning.

 WARNING!**Operation - Freewheel Mode**

In order to prevent the wheelchair from rolling away, ensure that the wheelchair is on a level surface before releasing the brakes.

In order to avoid personal injury do not use your Permobil in freewheel mode without an attendant present. Do not attempt to put the wheelchair in freewheel mode by yourself while seated in it.

Do not put your Permobil in freewheel mode while on an incline. This could cause the wheelchair to roll on its own, causing injury and property damage, including damage to the wheelchair.

 CAUTION!**Driving on a Loose/Soft Surface**

When the wheelchair is set to its lowest speed and the batteries are not fully charged, driving on certain surfaces, for example gravel, sand or thick carpeting, can involve constrained navigability.

 CAUTION!**Driving in Darkness**

Driving in the dark may only be done if your wheelchair is equipped with functioning lighting in the front and the back, or as per the applicable national or local traffic regulations.

 WARNING!**Passengers**

The wheelchair is not intended to transport passengers, regardless of the age of the passenger. The Maximum User Weight stated in the Owner's Manual for your seating system includes the user and any personal effects. The Maximum limit should not be exceeded. The wheelchair's manoeuvrability and stability can be degraded as a result.

 WARNING!**Driving with Seat Lift/Seat Tilt/ Backrest Recline**

Be careful in making sure that nothing gets stuck between the chassis and the seat when the seat lift/seat tilt is operated. Operating the seat lift, seat tilt/ backrest recline changes the center of gravity and increases the risk of tipping over. Always drive in low speed and only use those seat functions on level ground, and not on hills, ramps, slopes or other inclines. Using those seat functions while driving on inclines can lead to personal injury and property damage, including damage to the wheelchair.

 WARNING!**Center of Balance**

The possibility of this wheelchair tipping and the point where this wheelchair will tip forward, back or to the side depends on its center of balance. Please note that the following factors can affect the wheelchair's center of balance:

- Elevation of the seat
- Height and angle of the seat
- Body position or weight distribution
- Driving on an incline such as a ramp or a hill
- Use of a backpack or other accessories, depending on the amount of weight added.
- If your wheelchair begins to move in an unexpected manner, immediately release the joystick to stop the wheelchair. Except in an emergency, do NOT use the on/off button to stop your wheelchair, as this will cause the wheelchair to stop abruptly and may cause personal injury.

 WARNING!**Fixed seat post**

Adjusting the seat height may only be performed by an authorized service provider. See the service manual for more information.

 **WARNING!****Positioning Belt**

Permobil positioning belts are designed to position the user only and will not protect you in an accident. You may even receive further injury from the belts.

 **WARNING!**

Support Wheels

If your wheelchair is equipped with support wheels, they must always be mounted when the wheelchair is being driven.

⚠ WARNING!**Transfer into and out of the chair**

Be sure that the power is turned OFF before entering or leaving the wheelchair and before lifting the control side armrest.

When transferring into or out of the wheelchair, every precaution should be taken to reduce the distance between the wheelchair and the place to which the user is transferring. Overextending this distance can cause user to overexert, lose balance, or fall.

Permobil recommends that users transfer in the presence of or with the assistance of an attendant.

Use caution when bending or reaching.

Never use the joystick as a handhold or point of support.

Do not use foot plates or armrests as supports when transferring into or out of the wheelchair. The footplates and armrests are not designed to be weight-bearing structures. Excessive force may cause them to give way, resulting in personal injury or property damage, including damage to the wheelchair.



 **WARNING!****Transport**

The wheelchair must only be transported in vehicles approved for this purpose. Always ask for confirmation of the transporter that the vehicle is suitable designed, insured and equipped to transport a person in a wheelchair. A wheelchair is not designed as a car seat and cannot offer the same degree of safety that is offered by standard car seats, no matter how securely it has been fastened in the vehicle concerned.

Carefully check that the wheelchair is properly fixed and that the break release has not been activated (the wheelchair drive wheels must be locked). The wheelchair must only be locked into position with loading straps from the tie-down points at the front and rear, marked with yellow stickers, or by using a Permlock locking system. The wheelchair must not be secured onto any other part of the wheelchair including the seat.

If the wheelchair needs to be transported with the user seated in it, be sure to use an approved attachment system suitable for the total weight of the wheelchair to secure the wheelchair.

- Permobil recommends that the wheelchair be equipped with a headrest and that this is used during transportation.
- During transportation, it is essential that you are secured with a three-point safety belt that is attached to the floor and a side of the vehicle.
- Permobil positioning belts are designed to position the user only and not to protect you in the event of a motor vehicle accident. The positioning belts do not replace use of a vehicle mounted restraint.

 **CAUTION!****Driving in Extreme Climate Conditions**

Permobil's wheelchairs are designed to withstand most adverse weather conditions, however to minimize the risk of being caught in difficult situations you should avoid using the wheelchair outdoors during, for example, severe cold, heavy rain or thick snow.

Also bear in mind that certain surfaces on the wheelchair can be heated up or cooled down in the event of prolonged exposure to intense sunlight or cold respectively.

 WARNING!**Maintenance and Service**

Carry out only the service and maintenance which are stated in the Owner's Manual. All other service and maintenance including programming of the control system must be performed by a qualified service technician authorized by Permobil to perform such service on Permobil products. Incorrect settings could result in unsafe operation of the wheelchair and could cause the chair to become unstable or uncontrollable. Such modifications may also void the wheelchair's warranty.

During all work on the electrical system of the wheelchair, the Circuit Breaker must always be in OFF position. To avoid the risk of electric shock, use extreme caution when using metal objects while working on the batteries. Short-circuiting can easily cause an explosion. Never perform service on the wheelchair without using protective gloves and goggles. Failure to do so can lead to personal injury.

Do not use parts or accessories not authorized by Permobil. Use of unapproved "aftermarket" accessories and parts may cause changes in the wheelchair, which may make the wheelchair unstable or uncontrollable. Such use may also void the warranty on the wheelchair.

Connecting any unapproved electrical or electronic devices to the wheelchair's electrical system can cause damage to the chair and caused the chair to become uncontrollable or drive erratically. Such use may also void the warranty. The wheelchair is heavy and contains many moving parts, which means that the risk of being caught between them is always present.

 WARNING!**Charging of Batteries**

Charging must be done in a well-ventilated room, not in a wardrobe or closet. Charging must not be done in a bathroom or wet room. Only chargers with a max 10 A charging current (average value) may be used (the RMS value of the charging current must not exceed 12 A). When the charger is connected, the chair must not and cannot be driven.

 WARNING!**Changing Batteries and Fuses**

The Circuit Breaker must always be in OFF-position when batteries and fuses are replaced. Observe care in the use of metallic objects when working with batteries. A short-circuit can easily cause an explosion. Always use protective gloves and protective eye-glasses.

 WARNING!**Safety Circuits**

Permobil products are equipped with safety circuits. Inhibit circuits prevent the wheelchair from driving under certain conditions. Speed reduction circuits limit the wheelchair's maximum speed under certain conditions. Limit switch circuits limit the wheelchair's functions under certain circumstances. Overload protection circuits shut the wheelchair off in case of an overload. The user should stop using the wheelchair immediately and consult an authorized Permobil distributor if any of these circuits should become disabled.

Any attempt to modify the safety circuits will result in unsafe operation of the wheelchair and could cause the chair to become unstable or uncontrollable. Such modifications may also void the wheelchair's warranty.

 CAUTION!**Recycling of Batteries**

Used or broken drive batteries should be taken care of in an environmentally correct manner in accordance with locally applicable recycling directions.

 WARNING!**Filling Air into tires**

Check at regular intervals that the wheelchair's tires have the prescribed tire pressure. Incorrect tire pressure can cause deteriorating stability and maneuverability.

The prescribed tire pressure is 200-250 kPa (2-2.5 bar).

Note that overfilling causes a risk of explosion.

 WARNING!**Changing Tires**

Avoid the use of sharp-edged tools when working with tires.

 WARNING!**Storage**

The wheelchair and its accessories must always be shut off when they are not being used. Always store the wheelchair so that access for unauthorized individuals is avoided.

Never store the wheelchair in a room in which condensation can arise (mist or dampness on the surfaces) e.g. in pool areas, laundry rooms, or similar rooms.

If you are unsure as to how your wheelchair and its accessories should be properly stored, contact your supplier or Permobil for more information.

 WARNING!**Damages/malfunctions on the wheelchair and its accessories**

If you experience that the wheelchair in any manner is not behaving as expected or if you suspect that something is wrong: Stop driving as soon as possible, shut off the wheelchair and contact your service contact or Permobil for more information.

It's also of greatest importance that Permobil be informed if the wheelchair and its accessories have been subjected to transport damages, damages during driving or damages due to another cause as soon as possible after the event. There exists a risk that the wheelchair and its accessories can no longer be used in a safe and secure manner.

 CAUTION!**EMC Requirements**

The electronics of an power wheelchair can be affected by external electromagnetic fields (for example from mobile telephones). Similarly, the electronics of the wheelchair itself can also emit electromagnetic fields that can affect the immediate surroundings (for example certain alarm systems in businesses).

The limit values for Electromagnetic Compatibility (EMC) with respect to power wheelchairs is set in the harmonized standards for the EU in the Medical Devices Directive, No. 93/42/EEC.

Permobil's electronic wheelchair's comply with these limit values.

DESIGN & FUNCTION

General	34
Drive package	35
Wheels	35
Lights and reflectors	36
Batteries	37

General

The Permobil K300/C300/C300s is an electric wheelchair for outdoor and indoor driving. It is intended for people with physical disabilities.

The wheelchair consists of a chassis and a seat. The chassis contains the wheelchair's electronics, power supply and drive functions. The seat consists of a seat frame, seat plate/back rest, arm rest/leg rest and any accessories/options such as a head rest, calf rest, chest support, etc. The chassis can be combined with different seat models, which are supplied with a separate user manual.

In this user manual, we have chosen to show the wheelchair with our Corpus 3G seat. However, the operation of the chassis and most of its functions are the same regardless of the seat model chosen.

- | | |
|------------------------|-----------------------|
| 1. Back rest | 6. Support wheels |
| 2. Control panel | 7. Drive wheels |
| 3. Seat | 8. Rear caster wheels |
| 4. Serial number label | 9. Chassis |
| 5. Foot plates | 10. Arm rest |

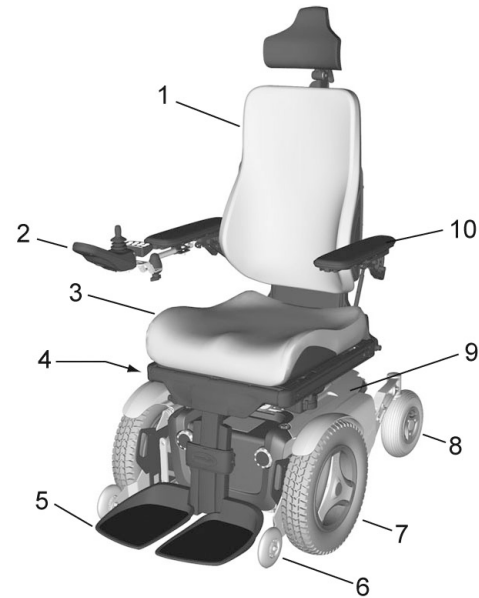

Figure 1. C300 Corpus 3G

Drive package

The Permobil K300/C300/C300s is equipped with a drive package for each drive wheel. The drive package consists of an electric motor with a drive gear and magnetic wheel lock.

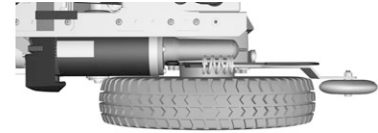

Figure 2. Drive package

Wheels

The wheelchair's drive wheels, are available with pneumatic or Flat-Free (Foam Filled) tires. The caster wheels, have solid polyurethane tires.

Lights and reflectors

The wheelchair is equipped with reflectors on the front, rear and sides. Front/rear lights and turn indicators are optional.

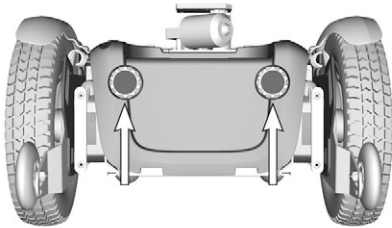

Figure 3. Front Reflectors

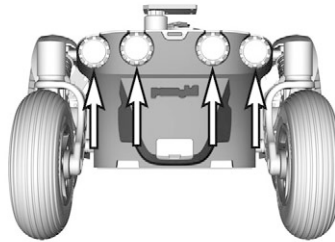

Figure 4. Rear Reflectors

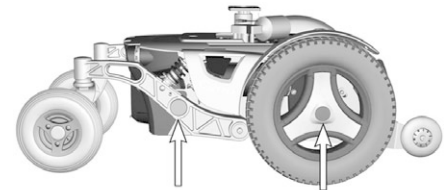

Figure 5. Side Reflectors

Batteries

The wheelchair's batteries are located under the covers of the chassis. Both of the batteries are easily accessible for maintenance and replacement.

WARNING!

Be careful when using metal objects when working with batteries. A short-circuit can easily cause an explosion. Always use safety gloves and safety goggles.
Remember that the batteries are heavy and must be handled with great caution.

CAUTION!

Used or malfunctioning batteries should be disposed of responsibly in accordance with local recycling regulations.

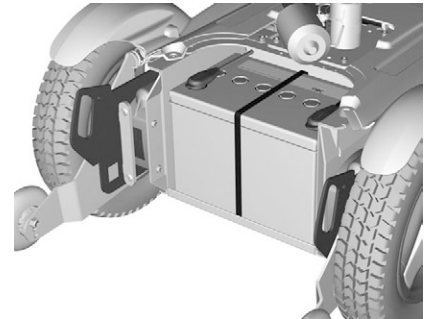

Figure 6. Front Battery

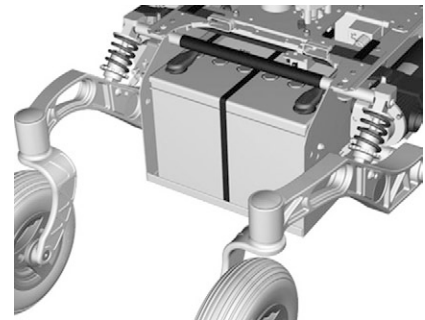

Figure 7. Rear Battery

Electronics

Circuit Breaker

The Permobil K300/C300/C300s is equipped with an automatic Circuit Breaker, which can be reset after having been triggered. It also functions as a battery isolator and is controlled (ON/OFF) via the lever located behind the rubber protection at the bottom of the rear chassis cover.

WARNING!

If the main fuse is triggered, there is often a major electrical fault. The cause of the fault should be checked carefully before the switch is reset. Contact Service in case of doubt.

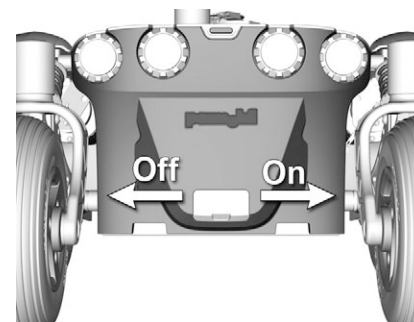

Figure 8. Circuit Breaker

Charging socket

The charging socket is located on the control panel.

CAUTION!

Always switch off the power supply to the control panel before interrupting the power with the main fuse.

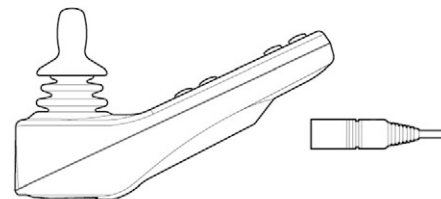

Figure 9. Charging socket

 **WARNING!**

If the main fuse is triggered, there is often a major electrical fault. The cause of the fault should be checked carefully before the switch is reset. Contact Service in case of doubt.

R-NET CONTROL PANEL WITH LCD COLOR DISPLAY

General	42
Charger Socket.....	43
Function Buttons	44
Jack Sockets	47
Display	48

General

The Control Panel consists of a joystick, function buttons and a display. At the front of the panel is the Charger Socket. Two Jack Sockets are located on the bottom of the panel.

Your wheelchair may also be equipped with an extra Seat Control Panel in addition to the control panel.



Figure 10. Control Panel

Charger Socket

WARNING!

The wheelchair's warranty will be voided if any device other than a battery charger supplied with the wheelchair, or the lock key is connected into the control panels charger socket.

This socket should only be used for charging or locking the wheelchair. Do not connect any type of programming cable into this socket. This socket should not be used as a power supply for any other electrical device. Connection of other electrical devices may damage the control system or affect the E.M.C. performance of the wheelchair.).

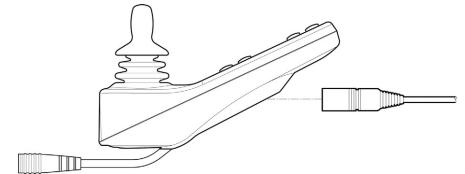

Figure 11. Charger Socket

Function Buttons

On the control panel there are a total of 10 Function Buttons.

On/Off Button

The On/Off button applies power to the control system electronics, which in turn supply power to the wheelchair's motors.

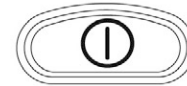

Figure 12. On/Off Button

Horn Button

The horn will sound while this button is depressed.



Figure 13. Horn Button

Maximum Speed Buttons

These buttons decrease/increase the wheelchairs maximum speed. Depending on the way the control system has been programmed a momentary screen may be displayed when these buttons are pressed.

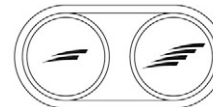

*Figure 14. Speedbuttons, Decrease/
Increase*

Mode Button

The Mode button allows the user to navigate through the available operating Modes for the control system. The available modes are dependant on programming and the range of auxiliary output devices connected to the control system.



Figure 15. Mode Button

Profile Button

The Profile button allows the user to navigate through the available Profiles for the control system. The number of available Profiles is dependant on how the control system is programmed. Depending on the way the control system has been programmed a momentary screen may be displayed when the button is pressed.



Figure 16. Profile Button

Hazard Warning Button and LED

NOTE!

Only active if the wheelchair is provided with lights

This button activates/inactivates the wheelchairs hazards lights. this function is used when the wheelchair is positioned in a way making it a obstruction for others. Push the button to activate the hazard lights and push it again to inactivate them. When activated the indicator LED will flash in sync with the wheelchair's indicators.



Figure 17. Hazard Button and LED

Lights Button and LED

NOTE!

Only active if the wheelchair is provided with lights

This button activates and de-activates the wheelchair's lights. Depress the button to turn the lights on and depress the button again to turn them off. When activated the lights LED will illuminate.



Figure 18. Lights Button and LED

Left Indicator Button and LED

NOTE!

Only active if the wheelchair is provided with lights

This button activates and de-activates the wheelchair's left indicator. Depress the button to turn the indicator on and depress the button again to turn it off. When activated the left indicator LED will flash in sync with the wheelchair's indicator.



Figure 19. Left Indicator and LED

Right Indicator Button and LED*)

NOTE!

Only active if the wheelchair is provided with lights

This button activates and de-activates the wheelchair's right indicator. Depress the button to turn the indicator on and depress the button again to turn it off. When activated the right indicator LED will flash in sync with the wheelchair's indicator.



Figure 20. Right Indicator and LED

Jack Sockets

The External On/Off Switch Jack (1) allows the user to turn the control system on and off using an external device, such as a buddy button.

The External Profile Switch Jack (2) allows the user to select Profiles using an external device, such as a buddy button. To change the Profile whilst driving simply press the button.

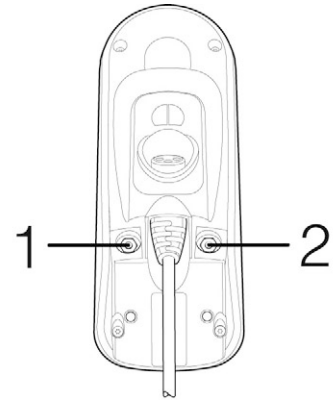

Figure 21. Jack Sockets

Display

The status of the control system can be understood by observing the display. The control system is on when the display is backlit.

Screen Symbols

The Drive screen for the R-net has common components, which will always appear, and components which will only appear under certain conditions. Below is a view of a typical Drive screen in Profile 1.

- A. Clock
- B. Speedometer
- C. Profile name
- D. Current profile
- E. Battery indicator
- F. Max. Speed indicator

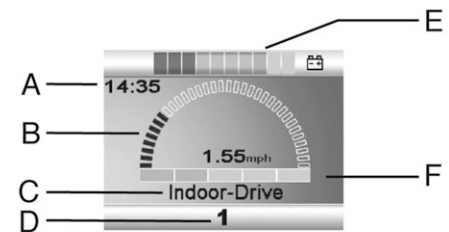

Figure 22. Drive Screen

Battery Indicator

This displays the charge available in the battery and can be used to alert the user of the status of the battery.

Steady: This indicates that all is well.

Flashing Slowly: The control system is functioning correctly, but you should charge the battery as soon as possible.

Stepping Up: The wheelchair batteries are being charged. You will not be able to drive the wheelchair until the charger is disconnected and you have switched the control system off and on again.



Figure 23. Battery Indicator

Speed Indicator

This displays the current speed setting.

The speed setting is adjusted using the Speed Buttons.



Figure 24. Speed Indicator

Current Profile

The Profile Number describes which Profile the control system is currently operating in. The Profile Text is the name or description of the Profile the control system is currently operating in.



Figure 25. Current Profile

In Focus

When the control system contains more than one method of direct control, such as a secondary Joystick Module or a Dual Attendant Module, then the Module that has control of the wheelchair will display the In Focus symbol.



Figure 26. In Focus

Speed Limit

If the speed of the wheelchair is being limited; for example, by a raised seat, then this symbol will be displayed. If the wheelchair is being inhibited from driving, then the symbol will flash.



Figure 27. Speed Limit

Restart

When the control system requires a restart; for example, after a module re-configuration, this symbol will be flashed.



Figure 28. Restart

Control System Temperature

This symbol is displayed when the control system has intentionally reduced its own power, in order to protect itself against heat damage.



Figure 29. Control System Temperature

Motor Temperature

This symbol is displayed when the control system has intentionally reduced the power to the motors, in order to protect them against heat damage.



Figure 30. Motor Temperature

Timer

This symbol is displayed when the control system is changing between different states. An example would be entering into Programming Mode. The symbol is animated to show the sands falling.



Figure 31. Timer

E-Stop

If the control system is programmed for latched drive or actuator operation, then it is normal for an Emergency Stop Switch to be connected into the External Profile Switch Jack. If the Emergency Stop Switch is operated or disconnected, this symbol will flash.



Figure 32. E-Stop

Installation menu

The installation menu permits the user to set the clock, the display brightness, background color etc. Access the menu by holding down the keys for higher and lower maximum speed simultaneously. Scroll through the menu by moving the joystick up or down.

Exit the installation menu by first selecting "Exit" at the bottom of the menu and then moving the joystick to the right.

Setting the time (Set Time) (Setting the time (Set Time)): Shows the total distance traveled by the control system.

Displaying the time (Display Time) (Displaying the time (Display Time)): Select "Display Time" in the menu. Move the joystick right or left to select 12 or 24 hour display, or "Off" to remove the clock from the display.

Distance measurement (Distance) (Distance measurement (Distance)): Select "Distance" in the menu. Move the joystick to the right to go to the menu for setting distance measurement. Then select "Total distance", "Trip", "Distance display" or "Reset" by moving the joystick up or down.

- **Total distance** (Total Distance): Shows the total distance traveled by the control system.
- **Trip** (Trip Distance): Shows the total distance traveled since the last reset.
- **Distance display** (Display Distance): Selects Trip or Total Distance in the display.
- **Reset** (Clear trip distance): Move the joystick to the right to reset the Trip measurer.
- **Exit** (Exit): Move the joystick to the right to exit the installation menu.

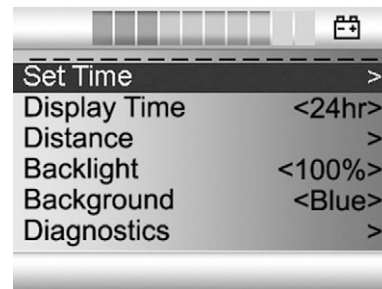

Figure 33. Installation menu

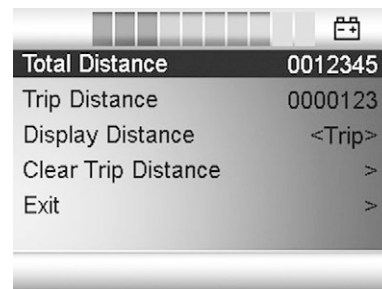

Figure 34. Distance measurement

R-NET CONTROL PANEL WITH LCD MONOCHROME DISPLAY

General	54
Charger Socket.....	55
Function Buttons	56
Jack Sockets	59
Display	60
Locking/unlocking the Control System.....	61
Seat functions	63

General

The Control Panel consists of a joystick, function buttons and a Display. At the back of the panel you also find the Charger Socket and two Jack Sockets.

Your wheelchair may also be equipped with an extra Seat Control Panel in addition to the control panel.



Figure 35. Control Panel

Charger Socket

WARNING!

The wheelchair's warranty will be voided if any device other than a battery charger supplied with the wheelchair, or the lock key is connected into the control panels charger socket.

This socket should only be used for charging or locking the wheelchair. Do not connect any type of programming cable into this socket. This socket should not be used as a power supply for any other electrical device. Connection of other electrical devices may damage the control system or affect the E.M.C. performance of the wheelchair.)

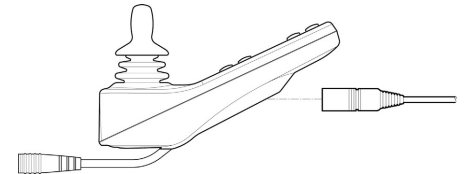

Figure 36. Charger Socket

Function Buttons

On the control panel there are a total of 10 Function Buttons.

On/Off Button

The On/Off button applies power to the control system electronics, which in turn supply power to the wheelchair's motors.

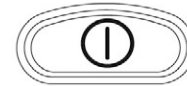

Figure 37. On/Off Button

Horn Button

The horn will sound while this button is depressed.



Figure 38. Horn Button

Maximum Speed Buttons

These buttons decrease/increase the wheelchairs maximum speed. Depending on the way the control system has been programmed a momentary screen may be displayed when these buttons are pressed.

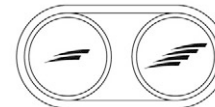

*Figure 39. Speedbuttons, Decrease/
Increase*

Mode Button

The Mode button allows the user to navigate through the available operating Modes for the control system. The available modes are dependant on programming and the range of auxiliary output devices connected to the control system.



Figure 40. Mode Button

Profile Button

The Profile button allows the user to navigate through the available Profiles for the control system. The number of available Profiles is dependant on how the control system is programmed. Depending on the way the control system has been programmed a momentary screen may be displayed when the button is pressed.



Figure 41. Profile Button

Hazard Warning Button and LED

NOTE!

Only active if the wheelchair is provided with lights

This button activates/inactivates the wheelchairs hazards lights. this function is used when the wheelchair is positioned in a way making it a obstruction for others. Push the button to activate the hazard lights and push it again to inactivate them. When activated the indicator LED will flash in sync with the wheelchair's indicators.



Figure 42. Hazard Button and LED

Lights Button and LED

NOTE!

Only active if the wheelchair is provided with lights

This button activates and de-activates the wheelchair's lights. Depress the button to turn the lights on and depress the button again to turn them off. When activated the lights LED will illuminate.



Figure 43. Lights Button and LED

Left Indicator Button and LED

NOTE!

Only active if the wheelchair is provided with lights

This button activates and de-activates the wheelchair's left indicator. Depress the button to turn the indicator on and depress the button again to turn it off. When activated the left indicator LED will flash in sync with the wheelchair's indicator.



Figure 44. Left Indicator and LED

Right Indicator Button and LED*)

NOTE!

Only active if the wheelchair is provided with lights

This button activates and de-activates the wheelchair's right indicator. Depress the button to turn the indicator on and depress the button again to turn it off. When activated the right indicator LED will flash in sync with the wheelchair's indicator.



Figure 45. Right Indicator and LED

Jack Sockets

The External On/Off Switch Jack (1) allows the user to turn the control system on and off using an external device, such as a buddy button.

The External Profile Switch Jack (2) allows the user to select Profiles using an external device, such as a buddy button. To change the Profile whilst driving simply press the button.

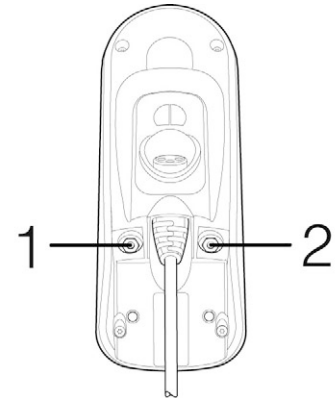

Figure 46. Jack Sockets

Display

The status of the control system can be understood by observing the display. The control system is on when the display is backlit.

Screen Symbols

The Drive screen for the R-net has common components, which will always appear, and components which will only appear under certain conditions. Below is a view of a typical Drive screen in Profile 1.

1. Current Profile
2. Profile Name
3. Battery Indicator
4. Speed Indicator

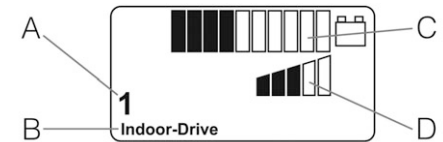

Figure 47. Drive Screen

Locking/unlocking the Control System

The Control System can be locked in one of two ways. Either using a button sequence on the keypad or with a physical Key. How the Control system is locked depends on how your system is programmed.

Keypad Locking

To lock the wheelchair using the keypad:

- While the control system is switched on, depress and hold the On/Off button.
- After 1 second the control system will beep. Now release the On/Off button.
- Deflect the joystick forwards until the control system beeps.
- Deflect the joystick in reverse until the control system beeps.
- Release the joystick, there will be a long beep.
- The wheelchair is now locked.

To unlock the wheelchair:

- If the control system has switched off, press the On/Off button.
- Deflect the joystick forwards until the control system beeps.
- Deflect the joystick in reverse until the control system beeps.
- Release the joystick, there will be a long beep.
- The wheelchair is now unlocked.



Figure 48. The Lock Symbol is displayed when the wheelchair is locked.

Key Locking

To lock the wheelchair with a key lock:

- Insert and remove a PGDT supplied key into the Charger Socket on the Joystick Module.
- The wheelchair is now locked.

To unlock the wheelchair:

- Insert and remove a PGDT supplied key into the Charger Socket.
- The wheelchair is now unlocked.

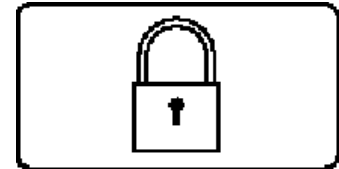

Figure 49. The Lock Symbol is displayed when the wheelchair is locked.

Seat functions

Not applicable to all seat models

On some seats the electrical functions can be controlled with the help of the control panel joystick. Some models are equipped with three memory locations. Each memory location can store the position of the seat's adjustment device. This means that it is easy to retrieve a seat position saved earlier.

Maneuvering the seat

⚠ CAUTION!

If the symbol "M" appears together with the seat icon, this means that a memory function has been activated. Move the joystick to the left or right to choose a seat function instead.

1. Press the "Mode" button one or more times until an icon for seat function appears in the control panel display. See fig.
2. Move the joystick to the left or right to select a seat function. The icon for the seat function selected appears in the display.
3. Move the joystick forwards or backwards to activate the function.

Below is an example of the icons that may be shown in the display. Which icons are shown varies depending on the seat model and available functions.

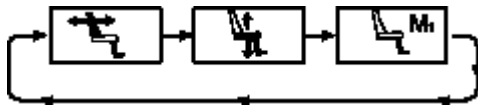

Figure 51. Move the joystick to the left or right to select a function. The icon for the function selected appears in the display.

Return to drive mode

Press the "Mode" button one or more times until a standard display image with speed indicator appears in the control panel display - see fig.

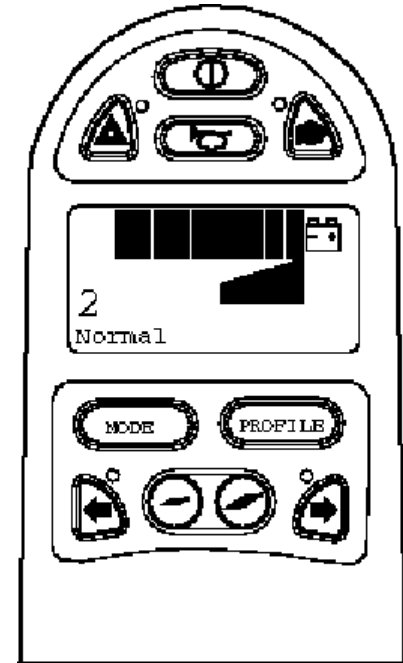

Figure 50. Standard display image with speed indicator.

Memory

The control system on some seats have three memory locations for seat positions. Each memory location can store the position of the seat's adjustment device. This means that it is easy to retrieve a seat position saved earlier.

Retrieving position from memory

1. Press the "Mode" button one or more times until a seat icon appears in the control panel display.
2. Move the joystick to the left or right to select a memory location (M1, M2 or M3). A seat icon and memory symbol "M" for the memory location selected are shown in the control panel display - see fig.
3. Move and hold the joystick forwards. The seat adjusts to the position stored earlier. For reasons of safety, the joystick must be held forwards until the seat is fully adjusted to the required position. Once the seat has adjusted to the saved position, it stops moving.

NOTE!

Movement of the seat can be stopped at any time by releasing the joystick.

Return to drive mode

Press the "Mode" button one or more times until a standard display image with speed indicator appears in the control panel display - see fig.

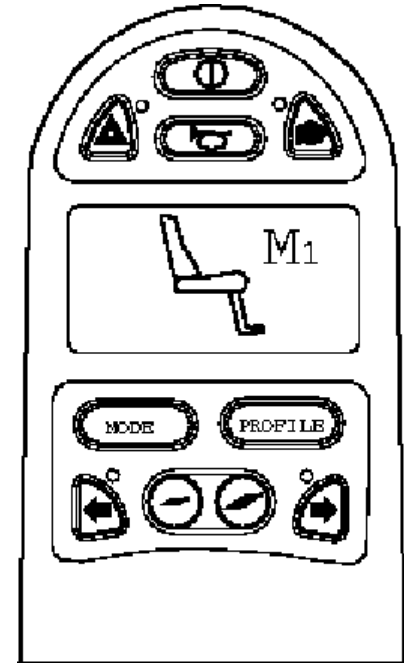

Figure 52. Memory function activated.

Saving position to memory

1. Set the seat's electrical functions to the desired mode.
2. If not activated, activate the seat/ memory function by pressing the "Mode" button one or more times until a seat icon appears in the control panel display.
3. Move the joystick to the left or right to select a memory location (M1, M2 or M3). A seat icon and memory symbol "M" for the memory location selected are shown in the control panel display - see fig.
4. Move the joystick backwards to activate the "save" function. An arrow will appear next to the memory symbol "M" - see fig.
5. Save the current position by moving the joystick forwards and holding it in that position until the arrow next to the memory symbol "M" disappears.

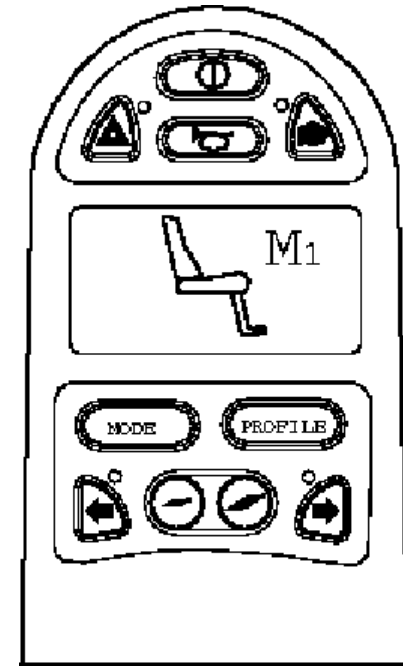

Figure 53. Memory function activated.

Return to drive mode

Press the "Mode" button one or more times until a standard display image with speed indicator appears in the control panel display - see fig.

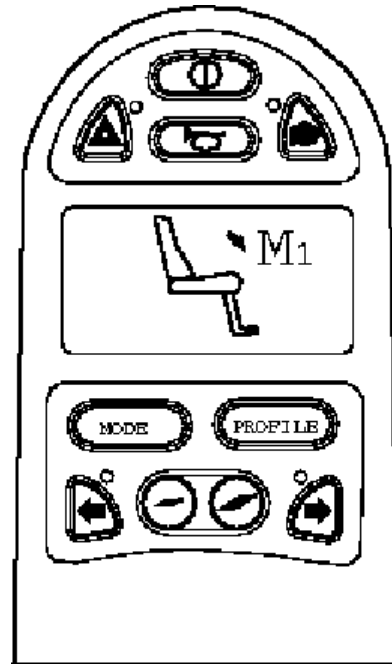

Figure 54. Save function activated.

R-NET LED CONTROL PANEL

General	70
Charger Socket.....	71
Function Buttons	72
Battery Voltage Indicator	75
Maximum Speed Indicator	76
Seat Indicator.....	77

General

The Control Panel consists of a joystick and function buttons. At the front of the panel is the Charger Socket.

Your wheelchair may also be equipped with a Seat Control Panel in addition to the control panel.



Figure 55. Control Panel

Charger Socket

WARNING!

The wheelchair's warranty will be voided if any device other than a battery charger supplied with the wheelchair, or the lock key is connected into the control panels charger socket.

This socket should only be used for charging or locking the wheelchair. Do not connect any type of programming cable into this socket. This socket should not be used as a power supply for any other electrical device. Connection of other electrical devices may damage the control system or affect the E.M.C. performance of the wheelchair.).

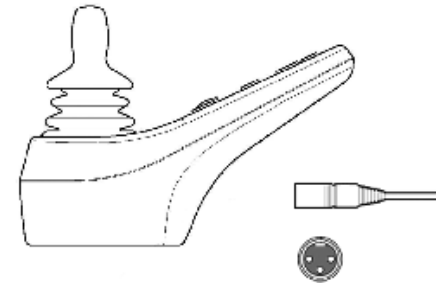

Figure 56. Charger Socket

Function Buttons

On the control panel there are a total of 10 Function Buttons.

On/Off Button

The On/Off button applies power to the control system electronics, which in turn supply power to the wheelchair's motors.

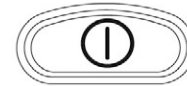

Figure 57. On/Off Button

Horn Button

The horn will sound while this button is depressed.



Figure 58. Horn Button

Maximum. Speed/Choice of Profile Button and LED

These keys normally reduce or increase the wheelchair's maximum speed. In special applications, the keys can instead control the choice of driving profile.

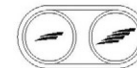

Figure 59. Maximum Speed/Choice of Profile Button and LED

Mode Button

These keys normally reduce or increase the wheelchair's maximum speed. In special applications, the keys can instead control the choice of driving profile.



Figure 60. Mode Button

Hazard Warning Button and LED

NOTE!

Only active if the wheelchair is provided with lights

This button activates/inactivates the wheelchairs hazards lights. this function is used when the wheelchair is positioned in a way making it a obstruction for others. Push the button to activate the hazard lights and push it again to inactivate them. When activated the indicator LED will flash in sync with the wheelchair's indicators.



Figure 61. Hazard Button and LED

Lights Button and LED

NOTE!

Only active if the wheelchair is provided with lights

This button activates and de-activates the wheelchair's lights. Depress the button to turn the lights on and depress the button again to turn them off. When activated the lights LED will illuminate.



Figure 62. Lights Button and LED

Left Indicator Button and LED

NOTE!

Only active if the wheelchair is provided with lights

This button activates and de-activates the wheelchair's left indicator. Depress the button to turn the indicator on and depress the button again to turn it off. When activated the left indicator LED will flash in sync with the wheelchair's indicator.

Right Indicator Button and LED*)

NOTE!

Only active if the wheelchair is provided with lights

This button activates and de-activates the wheelchair's right indicator. Depress the button to turn the indicator on and depress the button again to turn it off. When activated the right indicator LED will flash in sync with the wheelchair's indicator.



Figure 63. Left Indicator and LED



Figure 64. Right Indicator and LED

Battery Voltage Indicator

Shows the voltage remaining in the batteries (from left to right):

Red+Yellow+Green = Fully charged

Red+Yellow = Half charged

Red = Charge the batteries

A good way of using this indicator is to learn how it works while you are driving. Like a fuel gage in a car, it does not show exactly how much "fuel" is left, but it gives you a rough idea so that you can avoid unnecessary stops due to discharged batteries.

The indicator shows a more exact value after approximately 1 minute of travel.

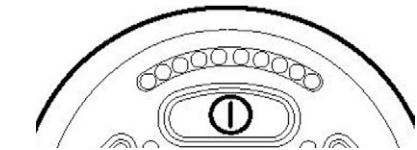

Figure 65. Battery Voltage Indicator

CAUTION!

The battery voltage indicator also functions as a "fault indicator" for the wheelchair's electronics. See page 96 for further information.

Maximum Speed Indicator

Speed

Indicates the maximum speed set for the wheelchair.

1 - 2 lamps = Low speed

3 - 4 lamps = Average speed

5 lamps = Max. speed

Driving profile

For special applications, the wheelchair can be programmed with more than one driving profile. In this case, the indicator's LEDs will instead display the selected driving profile. There can be up to 5 driving profiles.

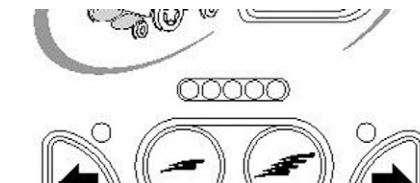

Figure 66. Maximum Speed Indicator

CAUTION!

The indicator for max. speed/driving profile also functions as a “fault indicator” for the wheelchair’s electronics. See page 96 for further information.

Seat Indicator

On certain seats the electrical functions for seat lift, seat angle, backrest angle and legrest angle are controlled with the control panel joystick. In this case the active seat function is indicated on the control panel seat indicator.

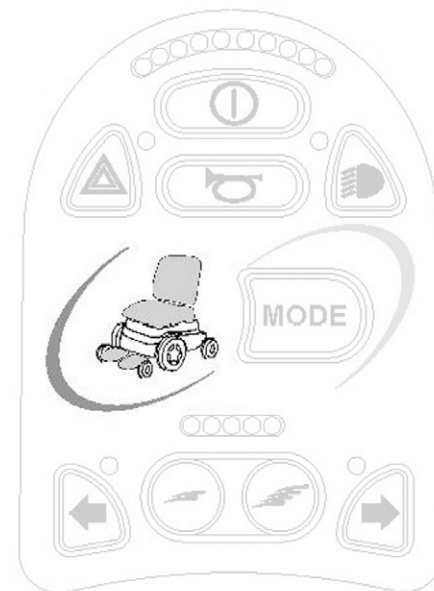

Figure 67. Seat Indicator

VR2 CONTROL PANEL

General	80
Charger Socket.....	81
Function Buttons	82
Battery Voltage Indicator	86
Maximum Speed Indicator	87
Locking/unlocking the wheelchair.....	88

General

The Control Panel consists of a joystick and function buttons. At the front of the panel is the Charger Socket.

The number of function keys/indication lamps varies, depending on the equipment your wheelchair has, for example whether it has lights or not and what seat functions it has.



Figure 68. VR2 Control Panel

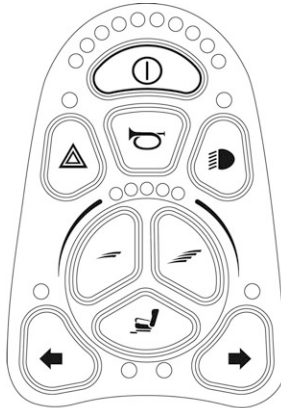

Figure 69. Control panel for wheelchair with lights and seat functions

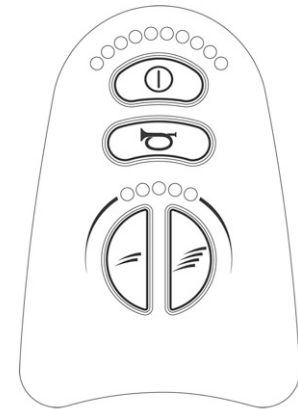

Figure 70. Control panel for wheelchair without lights and seat functions

Charger Socket

WARNING!

The wheelchair's warranty will be voided if any device other than a battery charger supplied with the wheelchair, or the lock key is connected into the control panels charger socket.

This socket should only be used for charging or locking the wheelchair. Do not connect any type of programming cable into this socket. This socket should not be used as a power supply for any other electrical device. Connection of other electrical devices may damage the control system or affect the E.M.C. performance of the wheelchair.).

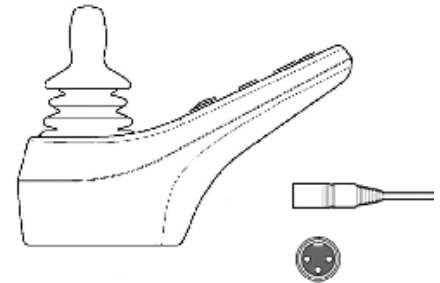

Figure 71. Charger Socket

Function Buttons

There are up to 10 function keys on the control panel. The number of function keys/indication lamps varies, depending on the equipment your wheelchair has.

On/Off Button

The On/Off button applies power to the control system electronics, which in turn supply power to the wheelchair's motors.



Figure 72. ON/Off Button

Horn Button

The horn will sound while this button is depressed.



Figure 73. Horn Button

Hazard Warning Button and LED

NOTE!

Only active if the wheelchair is provided with lights

This button activates/inactivates the wheelchairs hazards lights. this function is used when the wheelchair is positioned in a way making it a obstruction for others. Push the button to activate the hazard lights and push it again to inactivate them. When activated the indicator LED will flash in sync with the wheelchair's indicators.



Figure 74. Hazard Warning Button and LED

Lights Button and LED

NOTE!

Only active if the wheelchair is provided with lights

This button activates and de-activates the wheelchair's lights. Depress the button to turn the lights on and depress the button again to turn them off. When activated the lights LED will illuminate.



Figure 75. Lights Button and LED

Maximum Speed Setting Buttons

These keys normally reduce or increase the wheelchair's maximum speed. In special applications, the keys can instead control the choice of driving profile.

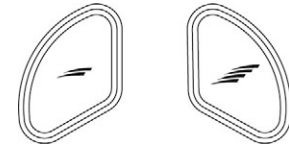

Figure 76. Maximum Speed Setting Buttons

Seat Function Button

NOTE!

Applies only if the wheelchair is fitted with electric seat functions
Activates/deactivates the seat functions with which your wheelchair is equipped. The function selected is then controlled using the joystick.



Figure 77. Seat Function Button

Indicator Buttons

NOTE!

Only active if the wheelchair is provided with lights

These keys activate and deactivate the wheelchair's left and right indicators. Press the key to activate the indicators. Press it again to deactivate them. When the indicators are active, the indicator lamp next to the control key flashes in time with the left or right indicators on the wheelchair.

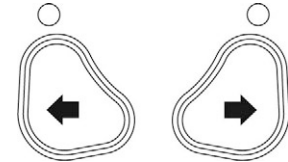

Figure 78. Indicator Buttons

Battery Voltage Indicator

Shows the voltage remaining in the batteries (from left to right):

Red+Yellow+Green = Fully charged

Red+Yellow = Half charged

Red = Charge the batteries

A good way of using this indicator is to learn how it works while you are driving. Like a fuel gage in a car, it does not show exactly how much "fuel" is left, but it gives you a rough idea so that you can avoid unnecessary stops due to discharged batteries.

The indicator shows a more exact value after approximately 1 minute of travel.

CAUTION!

The battery voltage indicator also functions as a "fault indicator" for the wheelchair's electronics. See page 96 for further information.

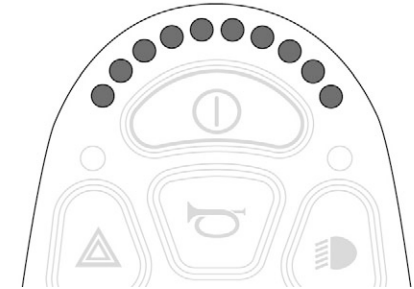

Figure 79. Battery Voltage Indicator

Maximum Speed Indicator

Speed

Indicates the maximum speed set for the wheelchair.

1 - 2 lamps = Low speed

3 - 4 lamps = Average speed

5 lamps = Max. speed

Driving profile

For special applications, the wheelchair can be programmed with more than one driving profile. In this case, the indicator's LEDs will instead display the selected driving profile. There can be up to 5 driving profiles.



Figure 80. Maximum Speed Indicator

CAUTION!

The indicator for max. speed/driving profile also functions as a “fault indicator” for the wheelchair’s electronics. See page 96 for further information.

Locking/unlocking the wheelchair

To avoid the wheelchair being used by unauthorized persons, the electronics unit can be locked by performing the following steps using the On/Off key and the joystick on the control panel:

Locking

- Ensure that the wheelchair is switched on. Press and hold down the On/Off key for approximately 1 second until a signal sounds and then release the key.
- Move the joystick forwards until a signal sounds. Then move it backwards until another signal sounds.
- Release the joystick. A longer signal sounds and the wheelchair is now locked.

Unlocking

- Switch on the chair with the On/Off key (the LEDs in the speed indicator will now "move" forwards and backwards).
- Move the joystick forwards until a signal sounds. Then move it backwards until another signal sounds.
- Release the joystick. A longer signal sounds and the wheelchair is now unlocked.

CAUTION!

The control system can be programmed so that it is switched off automatically if the wheelchair is not driven within a specific time. This time is normally set as 30 minutes.

HANDLING

General	90
Joystick Error	91
Driving technique	92
Driving rules	93
Manual brake release	98
Battery charging	101

General

The Permobil K300/C300/C300s is designed for use both indoors and outdoors. When you drive indoors, you must be careful in, for example, narrow passages, when going through doors and entrances and when using lifts, ramps, etc.

You should also consider the risk of crushing when you use the electric seat lift and seat angle functions, above all if the wheelchair has been driven under tables, benches, etc. Outdoors you should remember to drive very slowly down steep slopes and to be very careful when driving on uneven surfaces, up slopes, on side slopes and over obstacles. Always observe a good safety distance when driving near edges and precipices.

We recommend that you do repeated test drives in an environment in which you feel safe so that you are very familiar with how the wheelchair and its accessories behave in different situations before you start to use the wheelchair on public roads and in other public locations.

Driving

Check that the control panel is correctly fitted and the joystick is in the neutral position. Ensure that you have good support, for example the wheelchair's arm rest, for the part you use to handle the joystick with. Do not just use the joystick as a support. Fast turns and driving on uneven surfaces can interfere with your ability to handle the wheelchair safely.

1. Switch on the power by pressing the start key on the control panel.
2. Select a suitable driving profile with the PROFILE key (if the system is programmed for more than one driving profile).
3. Move the joystick carefully forwards to drive forwards or backwards to reverse.
4. The speed setting is adjusted using the keys for higher and lower speed. The wheelchair's electronics allow very slow driving over edges. You can drive up to the edge and then carefully drive over it.

Joystick Error

If the joystick is moved from the central position before, during or immediately after the control system is switched on, the screen image for a shifted joystick will be displayed for 5 seconds. On control panels without a display, the LEDs on the battery voltage indicator will "wander" backwards and forwards instead. If the joystick is not released during this time, a joystick error will be registered and the wheelchair will not drive. To enable the wheelchair to drive again, ensure that the joystick is in the central position. Then switch the wheelchair off and on again.

If control system detects an error in the wheelchair electronics which needs attention, a "Diagnostics screen" will appear on control panels with display. On control panels without display, the battery voltage indicator LEDs will flash rapidly instead. If this happens, you should get in touch with your service contact as soon as possible.

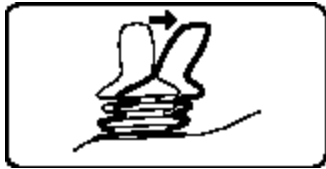

Figure 81. Shifted Joystick.



Figure 82. "Moving" LEDs.

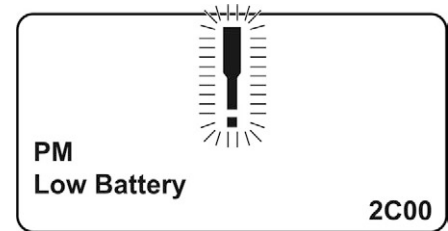

Figure 83. Diagnostics screen.

Driving technique

The control panel's electronics "interpret" the movements of the joystick and move the wheelchair as intended. For normal driving, the user needs to employ no complex techniques, which is an advantage if the user is inexperienced. A good way of starting is quite simply to move the joystick in the direction you want to go. The wheelchair then moves in the direction in which the joystick is pointing.

However, always remember to drive as gently as possible and to avoid sudden braking and evasive maneuvers.

CAUTION!

Do not take the first test drive on your own. The test drive is intended to establish how you and the wheelchair work together and you may need assistance.

Before driving, check that the brake release lever is in the drive position.

WARNING!

Do not just use the joystick as a support. Fast turns and driving on uneven surfaces can interfere with your ability to handle the wheelchair safely. If the wheelchair moves in a way that you do not want, **RELEASE THE JOYSTICK!** This always makes the wheelchair interrupt the current movement.

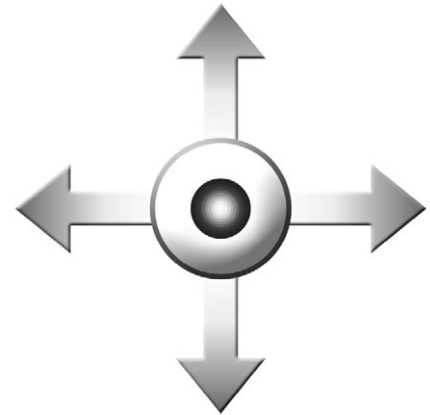

Figure 84. Joystick Maneuvering

Driving rules

Support wheels

Your wheelchair may be fitted with front support wheels to reduce the risk of tipping when driving over obstacles, etc. They must always be fitted when you drive.

⚠ WARNING!

If your wheelchair is fitted with support wheels, they must always be fitted when you drive. There is a risk of tipping. Always be aware that high speed and a longer braking distance mean a greater risk of accident. Never drive fast/at full speed in narrow passages, on narrow pavements, etc. because an incorrect maneuver/steering error can lead to a risk of accident.

Remember that a surface that is closed at the side will affect the wheelchair and may make it steer sideways. Therefore, never drive at full speed on surfaces that are closed at the side.

Using the seat angle function shifts the center of gravity, which may have a negative effect on the driving properties. So never drive at full speed if the seat has been angled a long way.

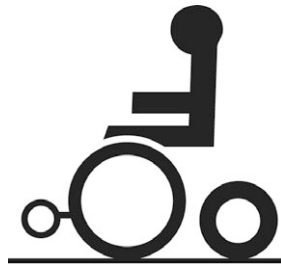

Figure 85. Support Wheels

Driving over obstacles

Do not drive the wheelchair over obstacles higher than 100 mm. If you drive over higher edges, there is a higher risk of tipping and of damage to the wheelchair.

You should always drive over obstacles with great caution.

⚠ WARNING!

Do not drive the wheelchair over obstacles higher than 100 mm. You should always drive over obstacles with great caution.

A raised seat lift/seat angle/back angle changes the center of gravity and increases the risk of tipping. Therefore, use these seat functions only on flat surfaces and always drive with great caution and at low speed.



Figure 86. Driving over obstacles

Driving on side slopes

You should always drive on side slopes with great caution.

Avoid sudden evasive maneuvers and never drive so fast that you are unable to control the wheelchair safely without risks.

You should be extremely careful when driving on side slopes with an uneven surface (for example grass, gravel, sand, ice and snow).

WARNING!

Do not drive the wheelchair on side slopes steeper than 6°. There is a risk of tipping.
A raised seat lift/seat angle/back angle changes the centre of gravity and increases the risk of tipping. Therefore, use these seat functions only on flat surfaces and always drive with great caution and at low speed.



Figure 87. Driving on side slopes

Driving downhill

You should always drive downhill at low speed and with great caution.

Avoid braking suddenly and sudden evasive maneuvers and never drive so fast that you are unable to control the wheelchair safely without risks.

You should be extremely careful when driving downhill on an uneven surface (for example grass, gravel, sand, ice and snow).

WARNING!

Do not drive downhill on a gradient greater than 10°. Dynamic stability according to ISO 7176-2 = 6°. A raised seat lift/seat angle/back angle changes the center of gravity and increases the risk of tipping. Therefore, use these seat functions only on flat surfaces and always drive with great caution and at low speed.



Figure 88. Driving downhill

Driving uphill

You should always drive uphill with great caution.

Avoid sudden evasive maneuvers and never drive so fast that you are unable to control the wheelchair safely without risks.

You should be extremely careful when driving uphill on an uneven surface (for example grass, gravel, sand, ice and snow).

WARNING!

Do not drive downhill on a gradient greater than 10°. Dynamic stability according to ISO 7176-2 = 6°. A raised seat lift/seat angle/back angle changes the center of gravity and increases the risk of tipping. Therefore, use these seat functions only on flat surfaces and always drive with great caution and at low speed.



Figure 89. Driving uphill

Manual brake release

General

The wheelchair is fitted with a manual brake release that can be released to make it possible to move the wheelchair manually. The brake release lever is located in the right side of the chassis.

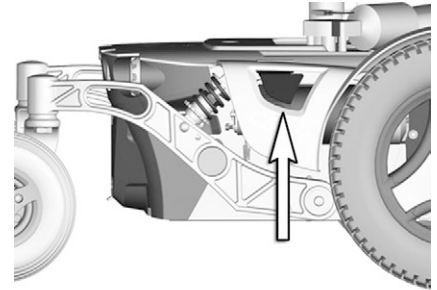

Figure 90. Brake release control.

⚠ WARNING!

Never use the wheelchair on a sloping surface with the brakes released. Always ensure that the wheelchair is switched off when the brakes are activated/deactivated.

To prevent the wheelchair from rolling off, ensure that it is on a dry, level surface before releasing the brakes.

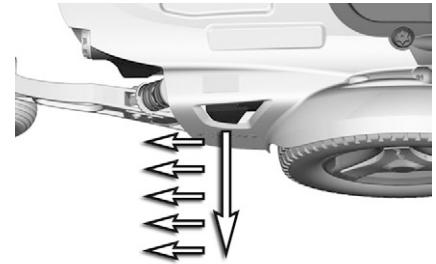

Figure 91. Releasing the brakes

Releasing the brakes

1. Switch off the wheelchair with the On/Off key on the control panel.
2. Press the release control back and, at the same time, pull it out from the chassis. See the picture. The chair can now be moved manually.

Resetting released brakes

1. Push the release control back into the chassis.



Figure 92. Resetting released brakes

⚠ WARNING!

Anyone who pushes a wheelchair with the brakes released must ensure that this is done safely without risks.

Always reset the brake release after moving the wheelchair manually.

When the brakes are released, it should not be possible to drive the chair.

If the chair can still be driven, contact your service contact or Permobil immediately.

Battery charging

How frequently you need to charge the batteries in your wheelchair depends on a number of factors, including how you use your wheelchair, the temperature and age of the batteries and how they are made. All batteries also gradually lose capacity as they age.

The most important factor for the life of the batteries is how much power is taken out of them before they are charged and how often they are charged/discharged.

To achieve the best life, the batteries should not be discharged completely. Always charge the batteries immediately after they have been discharged.

If the battery voltage indicator shows that the batteries appear to be losing power faster than normal, the batteries may be worn out and need to be replaced.

CAUTION!

If the batteries should be drained completely, it is important that you charge them up again as soon as possible since a complete loss of charge reduces the lifespan of the batteries.

 WARNING!

Use care in the use of metallic objects when working with batteries. A short-circuit can easily cause an explosion.

Always use safety gloves and protective eye-glasses.

Only chargers with a max 10A charging current (average value) may be used. (The RMS value of the charging current must not exceed 12A.

Charging must be done in a well-ventilated room, not in a wardrobe or closet. Charging must not be done in a bathroom or wet room.

The charger's charging cable must not be extended.

The charger can become hot and hence must not have anything covering it. The charger must be positioned so that there is an air gap on all of its sides, including below (do not set the charger on thick carpeting, for example).

The charger contact must be replaced if it is damaged or become hot during charging. Both the contact on the charger's cord and the wheelchair's control panel should be replaced if one of them is damaged or worn.

Replacement must be performed by qualified personnel.

Charging

Connect the charger plug into the battery charging socket on the control panel. The molded guide on the socket will help you to locate the plug.

NOTE!

Description and Use of Battery Charger, see supplied Owner's Manual.

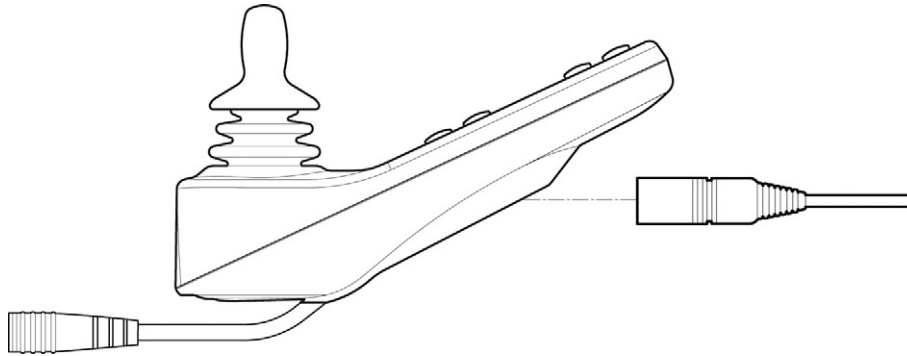

Figure 93. Charging socket on the control panel.

 WARNING!

Only use the battery charger that has been supplied with your wheelchair or recommended by Permobil. The use of incorrect chargers could damage the batteries, wheelchair, control system or charger itself, or may result in parts overheating creating the potential for burns or even fire.

To avoid sparking and unnecessary wear and tear of the charging socket be sure that the main voltage and the charger is in the OFF position when connecting/disconnecting the charging cable to the charging socket.

 CAUTION!

Ensure that the charger plug is pushed fully into position before turning on the battery charger. You will not be able to drive the wheelchair when the charger is connected. If the wheelchair does drive with the charger plugged in, contact an authorized Permobil service center as soon as possible.

TRANSPORT

General	106
Rear loading straps	108
General advice for air transport.....	109

General

The wheelchair must only be transported in a vehicle that is approved for such purposes.

Check that the wheelchair is properly fastened and that the wheel locks are engaged. When transporting the wheelchair in a vehicle, the wheelchair must be locked into position by running fastening straps through the transport eyes at the front and rear, marked with yellow stickers.

Secure the wheelchair according to the manufacturer of the vehicle restraint systems instructions. Always make sure that the fastening points on the transport vehicle are well-anchored.



Figure 94. The wheelchair must NOT be fastened by securing it to any part of the seat.

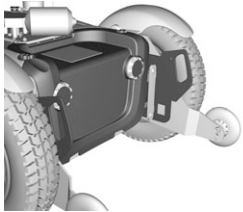

Figure 95. Front transport eyes.



Figure 96. Sticker for transport eyes.



Figure 97. Rear transport eyes.

 **WARNING!****Transport**

The wheelchair must only be transported in vehicles approved for this purpose. Always ask for confirmation of the transporter that the vehicle is suitable designed, insured and equipped to transport a person in a wheelchair. A wheelchair is not designed as a car seat and cannot offer the same degree of safety that is offered by standard car seats, no matter how securely it has been fastened in the vehicle concerned.

Carefully check that the wheelchair is properly fixed and that the break release has not been activated (the wheelchair drive wheels must be locked). The wheelchair must only be locked into position with loading straps from the tie-down points at the front and rear, marked with yellow stickers, or by using a Permolock locking system. The wheelchair must not be secured onto any other part of the wheelchair including the seat.

If the wheelchair needs to be transported with the user seated in it, be sure to use an approved attachment system suitable for the total weight of the wheelchair to secure the wheelchair.

- Permobil recommends that the wheelchair be equipped with a headrest and that this is used during transportation.
- During transportation, it is essential that you are secured with a three-point safety belt that is attached to the floor and a side of the vehicle.
- Permobil positioning belts are designed to position the user only and not to protect you in the event of a motor vehicle accident. The positioning belts do not replace use of a vehicle mounted restraint.

Rear loading straps

To ensure that the link arms and their bearings are not damaged, the angle of the loading straps must not exceed 25°. See the picture.

WARNING!

The angle of the loading straps must not exceed 25 degrees.

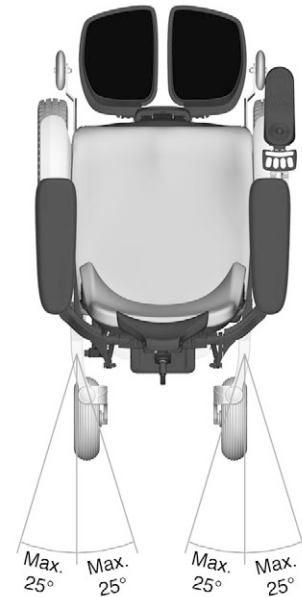

Figure 98. The angle of the loading straps must not exceed 25 degrees.

General advice for air transport

When transporting your wheelchair by air, you should primarily pay attention to the following three things:

 CAUTION!

If you do not know what type of main fuse your wheelchair has, contact Permobil or your service contact. Some airlines may refuse to accept acid batteries on board.

To ensure that the wheelchair can be transported safely and no nasty surprises crop up at the last minute, you should always contact the airline before you travel.

1. Batteries

Gel batteries: In most cases, they do not need to be removed from the wheelchair.

If your wheelchair has an automatic main fuse, this must always be in the Off position.

Acid batteries: Most airlines require that batteries be removed from the wheelchair and transported in special boxes that the airline may provide.

2. The wheelchair's dimensions and weight

How much the wheelchair weighs and how large it is are important, depending on the type of airplane in which the wheelchair is to be transported. The smaller the airplane is, the smaller the wheelchair may be/weight and vice versa. Always check with the airline what rules apply.

3. Preventing damage

When transported by air, the wheelchair will be put with other goods in a confined space. Therefore, it is important to take preventive action to minimise transport damage to the wheelchair.

Cover the control panel with soft, shock-absorbing material (foam plastic or similar) and fold it in towards the back rest. Protect other protruding objects in a similar manner. Tape any loose cables to the seat or covers.

MAINTENANCE AND REPAIRS

General	112
Toolbag	113
Frequency of maintenance and inspection	114
General - batteries/storage	115
Cleaning	117
Positioning belt	118
Brake release.....	118
Drive wheels	119
Pivot wheels	121
Battery replacement.....	124
Resetting the main fuse/battery isolator	126

General

To ensure that your wheelchair works well, it is important for it to be used correctly and regularly maintained. A well maintained wheelchair lasts longer and has a lower risk of faults.

WARNING!

Any unauthorized alterations to the wheelchair and its systems may lead to an increased risk of accident. All alterations to and interventions in the wheelchair's vital systems must be performed by a competent service engineer. In case of doubt, always contact a competent service engineer.

CAUTION!

Some repairs may require tools other than those supplied with the wheelchair. The main fuse must always be switched off when batteries and fuses are replaced. Always switch off the power supply to the control panel before interrupting the power with the main fuse.

Toolbag

The wheelchair comes with a toolbag with the following contents that can be used for maintenance and minor repairs.

TOOL	AREA OF USE
Allen keys	General maintenance/seat adjustment
11, 13 mm spanners	General maintenance/replacing batteries
Seat lift crank	Manually raising the seat lift
Security key	Locking/unlocking the wheelchair

Frequency of maintenance and inspection

Permobil recommends that the following maintenance and inspection schedule is followed. For all service related needs or questions turn to your authorized Permobil dealer.

Maintenance and Inspection Schedule	Daily	Weekly	Monthly	Yearly
Check battery level indicator and charge if necessary.	●			
Check that the joystick panel is not damaged.	●			
Ensure all removable parts are securely locked in place.	●			
Check belt for wear and make sure the buckle is operational.	●			
Check tires and inflate if necessary.		●		
Ensure lights and indicators are operational and clean.		●		
Clean wheelchair and upholstery.			●	
Check upholstery, seating, headrest, armpads and calfpads for wear.			●	
Check that the brake release and the brake release lever are working properly.			●	
Complete inspection, safety check and service should be performed by an authorized Permobil dealer.				●

General - batteries/storage

WARNING!

Any unauthorized alterations to the wheelchair and its systems may lead to an increased risk of accident. All alterations to and interventions in the wheelchair's vital systems must be performed by a competent service engineer. In case of doubt, always contact a competent service engineer.

- Please note that a battery discharges itself and that a discharged battery can burst when it is cold. If the wheelchair is to be stored unused for an extended period of time, the batteries must always be charged once a month to avoid them being damaged.
- The wheelchair must not be stored in areas subject to condensation (steam or moisture on surfaces), for example utility rooms or similar.
- The wheelchair may be stored in an unheated room. From the point of view of corrosion, it is best for the room to be a few degrees warmer than the surroundings as this keeps the room drier.
- If the wheelchair is fitted with acid batteries, the acid level should be checked regularly. If the wheelchair is fitted with gel batteries, the liquid level does not need to be checked.
- The life of the batteries depends entirely on regular charging.

Short-term storage

For the charging process to produce a battery with good capacity, the temperature in the storage room should not be lower than +5 degrees. If it is stored at a temperature below +5 degrees, there is a higher risk that the battery has not been fully charged when it comes to be used and also a higher risk of corrosion.

Long-term storage

The battery may be stored in an unheated room but it should be charged at least once a month for maintenance purposes.

Cleaning

Regular care and maintenance will prevent unnecessary wear and damage to your wheelchair. The following is general advice recommended by Permobil. For severe soiling of the upholstery or damage to the surface finish, contact Permobil for information.

Metal surfaces

For normal cleaning it is best to use a soft cloth/sponge, hot water and a mild detergent. Wipe down carefully with a cloth and water, and dry off.

Remove scuff marks from semi-matt surfaces with soft wax (follow manufacturer's instructions).

Remove scuff marks and scratches from shiny surfaces using car polish, either liquid or paste. After polishing, apply soft car wax to restore the original surface gloss.

Plastics

For normal cleaning, wash plastic surfaces with a soft cloth, mild detergent and hot water. Rinse thoroughly and dry with a soft cloth. Do not use solvents or abrasive kitchen cleaners.

Upholstery, cloth/vinyl

For normal cleaning, wash the upholstery with lukewarm water and a mild non-abrasive soap. Use a soft cloth or brush. Before the surface dries, wipe off any water/soap residues with a clean, dry cloth. This procedure may be repeated to remove stubborn dirt or stains. Ink spots can sometimes be removed by washing with soap and water followed by isopropyl alcohol.

Do not use any cleaning method that is not listed above, as other methods may attack the vinyl and cause eventual degradation.

If necessary, the cover may be removed before cleaning. See also the washing instructions on the upholstery materials.

Control panel

Use a soft cloth moistened with mild detergent and be careful when cleaning the joystick and the panel's display. Do not use solvents or abrasive kitchen cleaners. The panel must not be rinsed with water or any other liquid.

WARNING!

Never hose the wheelchair down as the electronics may be damaged. The wheelchair must always be turned off when being cleaned.

Positioning belt

Check the condition of the positioning belt regularly in case any damage or worn places have developed. If signs of damage or wear appear, replace the positioning belt immediately through your Permobil dealer.

Brake release

Check regularly, approximately once a month, that the brake release and the brake release lever are working properly.

When the brakes are released, it should not be possible to drive the wheelchair.

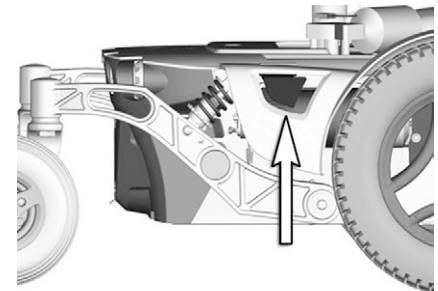

Figure 99. Brake release lever

Drive wheels

Filling tires with air

Check at regular intervals that the wheelchair's tires have the correct tire pressure. The incorrect tire pressure may result in lower stability and maneuverability. Too low tire pressure also results in abnormal wear and shorter range. Therefore, check regularly that the tire pressure is 200-250 kPa (2-2.5 bar).

1. Unscrew and remove the plastic cap on the valve on the tire.
2. Connect the compressed air nozzle to the valve and adjust the tire pressure to the correct level.



Figure 100. Filling valve.

Changing inner tube

NOTE!

Applies only if your wheelchair is fitted with pneumatic rear tires.

1. Switch off the main power switch on the control panel
2. Chock up the wheelchair so that the wheel turns freely and let out the air.
3. Remove the wheel, it's fitted with four screws.
4. Release the air.
5. remove the six screws holding the rim together.
6. Take the rim apart.
7. Replace the inner tube (2) in the tire (3) and fit together with the two rim halves (1&4). Tighten the six screws using a dynamometric wrench. **Tightening torque: 24 Nm.**
8. Fill the tire to recommended tire pressure, 200 kpa (2 bar).
9. Fit the wheel on to the wheelchair. Tighten the four screws using a dynamometric wrench. **Tightening torque: 24 Nm.**

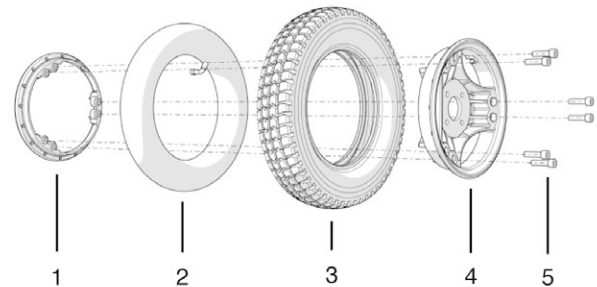

Figure 101. Changing inner tube.

Pivot wheels

Filling tires with air

NOTE!

Applies only if your wheelchair is fitted with pneumatic tires.

Check at regular intervals that the wheelchair's tires have the correct tire pressure. The incorrect tire pressure may result in lower stability and maneuverability. Too low tire pressure also results in abnormal wear and shorter range. Therefore, check regularly that the tire pressure is 200-250 kPa (2-2.5 bar).

1. Unscrew and remove the plastic cap on the valve on the tire.
2. Connect the compressed air nozzle to the valve and adjust the tire pressure to the correct level.



Figure 102. Filling valve.

Inner tube replacement

NOTE!

Applies only if your wheelchair is fitted with pneumatic rear tires.

1. Chock up the wheelchair so that the wheel turns freely and let out the air.
2. Take the wheel rim apart by unscrewing the three Allen screws (5) that hold it together.
3. Replace the inner tube.
4. Put the wheel rim together with the tire. Check that the inner tube is not caught between the halves of the wheel rim. Fill the tire with air.

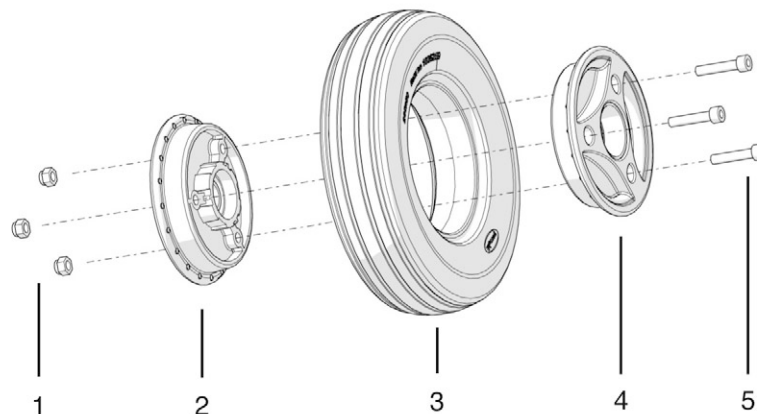

Figure 103. Changing tire.

**WARNING!**

The recommended tire pressure for front and rear tyres is 200-250 kPa (2-2.5 bar). Overfilling entails a risk of explosion.

The incorrect tire pressure may result in lower stability and maneuverability. So check regularly that the tires have the correct pressure.

Battery replacement

1. Place the wheelchair on a level surface.
2. Run/fold out the leg rest and raise the seat lift.
3. Turn off the main power switch on the control panel.
4. Put the circuit breaker in the "OFF" position. See page 126
5. Remove the two knobs holding the chassis cover. See fig. Remove the front chassis cover by pulling/lifting it upwards/forwards.
6. Remove the upper chassis cover by pulling it upwards/backwards.
7. Remove the rear chassis cover by lifting it upwards/fbackwards

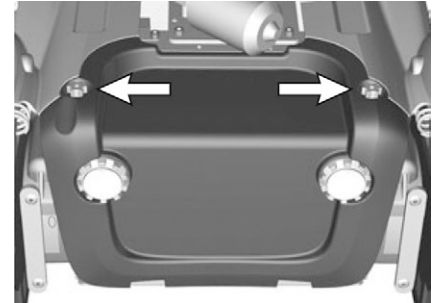

Figure 104. Knobs holding the front cover.

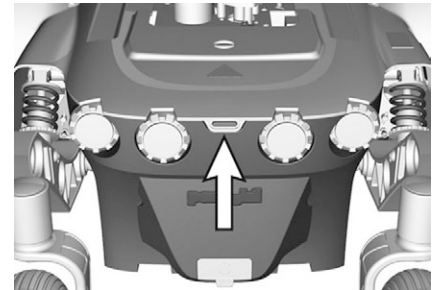

Figure 105. The rear cover is fitted together with the upper chassis cover.

8. Loosen the battery terminals, see figure. Also see the sticker on the inside of the chassis front cover.
9. Lift/pull the battery out using the battery strap.

NOTE!

The weight of the battery is 19 Kg.

⚠ WARNING!

Observe care in the use of metallic objects when working with batteries. A short-circuit can easily cause an explosion. Always use protective gloves and protective eye-glasses.

The batteries are heavy and must be handled with care.

Used or broken drive batteries should be taken care of in an environmentally correct manner in accordance with locally applicable recycling directions.

10. Lift/push the new battery in to the chassis using the battery strap.
11. Connect the battery terminals on the new battery. Also see the sticker on the inside of the chassis front cover.
12. Remount the front cover.

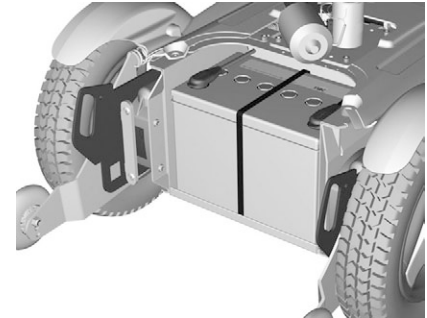

Figure 106. Front battery terminals.

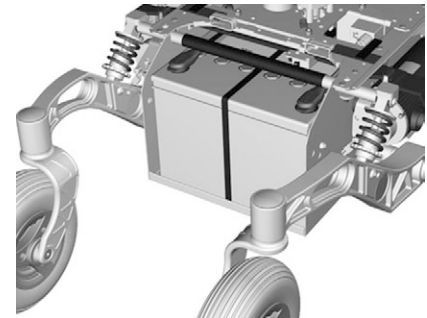

Figure 107. Rear battery terminals

Resetting the main fuse/battery isolator

The main fuse also functions as a battery isolator but it is called the main fuse in the owner's manual.

It is not normally necessary to replace the main fuse as it is automatic and can be reset when it has been triggered. It is reset by switching the switch to ON.

⚠ WARNING!

If the main fuse is triggered, there is often a major electrical fault. The cause of the fault should be checked carefully before the switch is reset. Contact Service in case of doubt.

⚠ CAUTION!

Always switch off the power supply to the control panel before interrupting the power with the main fuse.

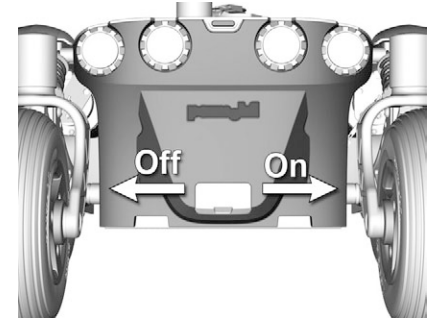

Figure 108. Main fuse.

ACCESSORIES

Accessories for Permobil power wheelchairs are subject to continuous development. Contact your nearest Permobil dealer for more information on the accessories available for your wheelchair.

TECHNICAL SPECIFICATIONS



Length 1115 mm.
Height 990 mm



Width 620 mm



Smallest transportation size
Length 883 mm
Width 620 mm
Height 815 mm.

TECHNICAL SPECIFICATIONS

General

Product name	Permobil K300/C300/C300S
Wheelchair class	B
Enclosure class	IPX4

Dimensions and weight

Length	1115 mm
Width	620 mm
Height	990 mm
Minimum transport dimensions, lxxwxh	883x620x815 mm
Weight, incl. batteries and Corpus 3G	153 kg

Wheels

Drive wheel tire dimensions	300 x 8
Pivot wheel tire dimensions	210 x 65
Rec. tire pressure	200 kPa (2-2.5 bar)

Performance

Range K300 / C300 / C300s	25–35 km. / 25–35 km. / 25–30 km.
Min. turning radius	625 mm
Reversing width	1220 mm.
Ability to Negotiate Obstacles (approach distance 0 cm)	50 mm.
Ability to Negotiate Obstacles (approach distance 50 cm)	100 mm.
Min. ground clearance	70 mm.
Hill-climbing ability	10 degrees

TECHNICAL SPECIFICATIONS

Safe slope	6 degrees
Sideways Slope Capability	6 Degrees
Static stability downhill	10 Degrees
Static stability uphill	9 Degrees
Static stability sideways	9 Degrees
Max. Speed forward K300 / C300 / C300s	7 km/h. / 7 km/h / .10 km/h

Electronics

VR2 drive electronics type	JSM / JSM—L / PM70 / PM70—A2
Rnet drive electronics type	JSM-L-SV / PM90 / PM120

Batteries

Recommended battery type	24 cells, gel
Battery capacity	2x60Ah
Charging time	8 hours

Fuses

Main fuse	63 A
-----------	------

Control force

Joystick	1,5 Nm
Keys	2 Nm

TROUBLESHOOTING

Troubleshooting guide	134
Diagnostics VR2.....	136
Diagnostics Rnet LED	141
Diagnostics R-net LCD.....	146
Repair of defective units.....	149

Troubleshooting guide

The following troubleshooting guide describes a number of faults and events which may occur when you use your wheelchair, together with suggested remedies. Note that this guide cannot describe all the problems and events which may occur and you should always contact your service contact or Permobil in case of doubt.

EVENT	POSSIBLE CAUSE	REMEDY
The wheelchair cannot be started.	Batteries discharged.	Charge the batteries.
	The cable connection to the control panel has come loose.	Insert the cable in the control panel.
	Main fuse switched to OFF position after, for example, battery replacement.	Reset the main fuse. See page 126
	Main fuse triggered.	See page 126
The wheelchair cannot be driven.	Battery charger connected.	Stop charging and disconnect the charging cable from the wheelchair's charging socket.
	Brake release activated.	Reset the brake release.
	Wheelchair locked with the security key.	Unlock the wheelchair. See page
The wheelchair "switches itself off" after a certain period of inactivity (20-30 min.).	The electronics' energysaving mode has been activated.	Switch the wheelchair on again using the start key on the control panel.
The wheelchair stops while being driven.	The cable connection to the control panel has come loose.	Insert the cable in the control panel.
	Main fuse triggered.	See page 126

EVENT	POSSIBLE CAUSE	REMEDY
The wheelchair can only be driven at reduced speed. (Applies with an electric seat lift and seat angle.)	Seat lift or seat angle raised too high. See .	Lower the seat lift or seat angle.
The wheelchair cannot be charged.	Main fuse switched to OFF position after, for example, battery replacement.	See page 126

Diagnosics VR2

Battery voltage indicator

Each time the wheelchair is started, parts of the wheelchair's electronics are checked. If any fault has occurred in these parts, this is displayed on the control panel's battery voltage indicator and the indicator for speed/driving profile in the form of one or more flashing lamps.

Troubleshooting and repairs must always be performed by competent personnel with good knowledge of the wheelchair's electronics. More information on troubleshooting and remedies can be found in the Service Manual for this wheelchair model.

Permanently on

Everything is in order. The number of lamps that light up depends on the voltage remaining in the batteries. If the batteries are fully charged, all the lamps light up.

Slowly flashing red lamps, 1–2 lamps

The batteries need to be charged immediately.

Rapid flashing, 1–10 lamps

A fault has been detected in the wheelchair's electronics and the wheelchair can not be driven.

- Switch of the wheelchair.
- Check that all visible cables and the cable to the control panel are connected correctly.
- Switch the wheelchair on again. If the fault persists, count the number of flashing lamps and check for a possible cause and remedy in the table on the adjoining page.
- Do not use the wheelchair until the problem has been remedied or you have received other information from your service contact.





 **WARNING!**





Diagnostics should only be performed by persons with sound knowledge of the wheelchair's electronic control system. Incorrect or poorly performed repair works may make it dangerous to use the wheelchair. Permobil accepts no liability for any personal injury or damage to the wheelchair and its surroundings that occurs on account of incorrect or poorly performed repair work.

CAUTION!

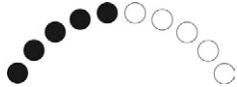
Any error signals on the indicators are not displayed while the wheelchair is being driven. They appear when it is next started.

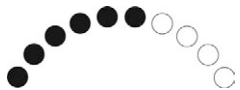
EXAMPLE OF ERROR MESSAGES AND REMEDIES

	<p>1 Lamp — Low battery voltage Check the condition of the batteries. Check the contact between the battery and the control unit.</p>
	<p>2 Lamps — Failure in left drive motor Check the connection of the left drive motor.</p>
	<p>3 Lamps — Short-circuit in left drive motor Check the left drive motor's contacts and cables.</p>
	<p>4 Lamps — Failure in right drive motor Check the connection of the right drive motor.</p>
	<p>5 Lamps — Short-circuit in right drive motor Check the right drive motor's contacts and cables.</p>

EXAMPLE OF ERROR MESSAGES AND REMEDIES	
	<p>6 Lamps — Battery charger connected Disconnect the battery charger.</p>
	<p>7 Lamps — Joystick error Check that the joystick has not been moved when the wheelchair is started.</p>
	<p>8 Lamps — Control system error Check the contacts to the output stage.</p>
	<p>9 Lamps — Failure in brake circuit Check the contacts to the magnetic brakes.</p>
	<p>10 Lamps — High battery voltage Check the battery and the contacts between the battery and the output stage.</p>

EXAMPLE OF ERROR MESSAGES AND REMEDIES**7+5 Lamps — Communication error**

A communication error has been indicated. Check that the cable to the control panel is not damaged and is correctly inserted.

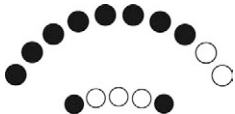
**Actuator indicator — Actuator error**

An actuator error has been indicated. If the wheelchair is fitted with more than one actuator, check which one is not working. Check the actuator's cable connections.

Diagnostics Rnet LED

Battery voltage indicator

Each time the wheelchair is started, parts of the wheelchair's electronics are checked. If any fault has occurred in these parts, this is displayed on the control panel's battery voltage indicator and the indicator for speed/driving profile in the form of one or more flashing lamps.

Troubleshooting and repairs must always be performed by competent personnel with good knowledge of the wheelchair's electronics. More information on troubleshooting and remedies can be found in the Service Manual for this wheelchair model.

 CAUTION!

Any error signals on the indicators are not displayed while the wheelchair is being driven. They appear when it is next started.

If any part is replaced without Permobil's approval, the wheelchair's warranty lapses. Permobil accepts no liability for any loss that occurs as a result of a component of the R-net control system being opened, adjusted or modified without permission.

Permanently on

Everything is in order. The number of lamps that light up depends on the voltage remaining in the batteries. If the batteries are fully charged, all the lamps light up.

Slowly flashing red lamps, 1–2 lamps

The batteries need to be charged immediately.

Rapid flashing, 1–10 lamps





A fault has been detected in the wheelchair's electronics and the wheelchair can not be driven.



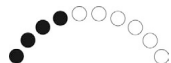
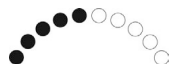
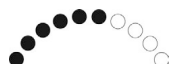

- Switch of the wheelchair.
- Check that all visible cables and the cable to the control panel are connected correctly.
- Switch the wheelchair on again. If the fault persists, count the number of flashing lamps and check for a possible cause and remedy in the table on the adjoining page.
- Do not use the wheelchair until the problem has been remedied or you have received other information from your service contact.

 **WARNING!**

Diagnostics should only be performed by persons with sound knowledge of the wheelchair's electronic control system. Incorrect or poorly performed repair works may make it dangerous to use the wheelchair. Permobil accepts no liability for any personal injury or damage to the wheelchair and its surroundings that occurs on account of incorrect or poorly performed repair work.

Example of error messages and remedies

EXAMPLE OF ERROR MESSAGES AND REMEDIES	
 A row of 10 circles representing indicator lamps. The first circle on the left is filled black, while the remaining 9 circles are empty.	1 Lamp — Low battery voltage Check the condition of the batteries. Check the contact between the battery and the control unit.
 A row of 10 circles representing indicator lamps. The first two circles on the left are filled black, while the remaining 8 circles are empty.	2 Lamps — Failure in left drive motor Check the connection of the left drive motor.
 A row of 10 circles representing indicator lamps. The first three circles on the left are filled black, while the remaining 7 circles are empty.	3 Lamps — Short-circuit in left drive motor Check the left drive motor's contacts and cables.
 A row of 10 circles representing indicator lamps. The first four circles on the left are filled black, while the remaining 6 circles are empty.	4 Lamps — Failure in right drive motor Check the connection of the right drive motor.
 A row of 10 circles representing indicator lamps. The first five circles on the left are filled black, while the remaining 5 circles are empty.	5 Lamps — Short-circuit in right drive motor Check the right drive motor's contacts and cables.
 A row of 10 circles representing indicator lamps. The first six circles on the left are filled black, while the remaining 4 circles are empty.	6 Lamps — Battery charger connected Disconnect the battery charger.
 A row of 10 circles representing indicator lamps. The first seven circles on the left are filled black, while the remaining 3 circles are empty.	7 Lamps — Joystick error Check that the joystick has not been moved when the wheelchair is started.

EXAMPLE OF ERROR MESSAGES AND REMEDIES	
	<p>8 Lamps — Control system error Check the contacts to the output stage.</p>
	<p>9 Lamps — Failure in brake circuit Check the contacts to the magnetic brakes.</p>
	<p>10 Lamps — High battery voltage Check the battery and the contacts between the battery and the output stage.</p>
	<p>7+5 Lamps — Communication error A communication error has been indicated. Check that the cable to the control panel is not damaged and is correctly inserted.</p>
	<p>Actuator indicator — Actuator error An actuator error has been indicated. If the wheelchair is fitted with more than one actuator, check which one is not working. Check the actuator's cable connections.</p>

Diagnosics R-net LCD

When an error or a fault occurs in the wheelchair's electronics, information on it is displayed in the control panel's display. This information can then be used to diagnose where the error/fault occurred and its cause.

Troubleshooting and repairs must always be performed by competent personnel with good knowledge of the wheelchair's electronics. More information on troubleshooting and remedies can be found in the Service Manual for this wheelchair model.

Diagnostic screens

Current diagnostic screen

When the control system's integrated protection circuits have been triggered so that the control system can no longer operate the wheelchair, a diagnostic screen is displayed in the control panel's display.

This indicates a system fault, i.e. R-net has detected a problem somewhere in the wheelchair's electrical system.

NOTE!

If the fault is in a module that is not currently being used, it may still be possible to drive the wheelchair, but the diagnostic screen is displayed occasionally.

Switch off the wheelchair and leave it off for a few minutes. Then restart the wheelchair. If the fault persists, you must switch off the wheelchair and contact your service contact. Write down the information displayed in plain text in the control panel's display and pass it on to your service contact.

Do not use the wheelchair until the problem has been remedied or you have received other instructions from your service contact.

 WARNING!

Diagnostics should only be performed by persons with sound knowledge of the wheelchair's electronic control system. Incorrect or poorly performed repair works may make it dangerous to use the wheelchair. Permobil accepts no liability for any personal injury or damage to the wheelchair and its surroundings that occurs on account of incorrect or poorly performed repair work.

 CAUTION!

If any part is replaced without Permobil's approval, the wheelchair's warranty lapses. Permobil accepts no liability for any loss that occurs as a result of a component of the R-net control system being opened, adjusted or modified without permission.

Example of a screen showing a system fault

1. Identified module

This indicates the control system module that detected the problem.

PM=Power Module

JSM=Joystick Module

2. Error message

The error message provides a brief description of the error type.

3. Error code

The four-digit code indicates which protection circuit has been triggered.

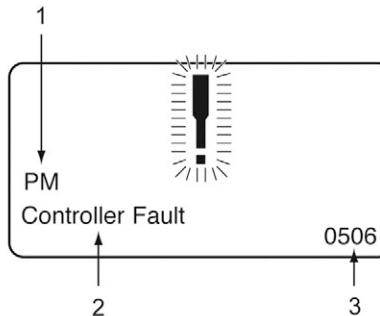

Figure 109. Example of a screen showing a system fault.

Repair of defective units

Apart from specific OEM-approved spare parts (contact Permobil for further information on these), there are no replaceable parts in the R-net control system. Consequently, defective units must be sent to Permobil or a Permobil-approved repairer for repair.

STICKERS

Take a good look at all the stickers on your wheelchair to become familiar with their meaning. These stickers contains important information for safe and proper use.

Never remove a sticker from your wheelchair. If a sticker becomes difficult to read or falls off, new replacement stickers may be ordered from Permobil.

Read the instructions

The sticker indicates that there are instructions that should be read and understood before use or before adjustment is performed.



Figure 110. Read the instructions.

Circuit Breaker/Battery Isolator

The sticker shows in what position the switch should be to turn the main power Off respectively On.

Description of the Circuit Breakers function is found on page 126.

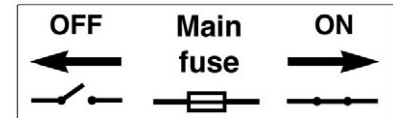

Figure 111. Circuit Breaker/Battery Isolater.

Wheel Locks

The sticker shows the wheel lock release levers position, in released respectively activated state.

Description of the wheel locks function is found on page 98.



Figure 112. Wheel Locks.

Tie-down point

The sticker indicates where the wheelchair must be secured during transport. There is a sticker next to each tie-down point.

Description of transport of the wheelchair is found on page 105.



Figure 113. Tie-down point

Crushing Hazard

The sticker indicates Crushing Hazard.



Figure 114. Crushing Hazard..

Battery Connections and Fuses

The sticker shows the polarity of the batteries and where the fuses are found on the wheelchair.

Description of changing batteries is found on page 124.

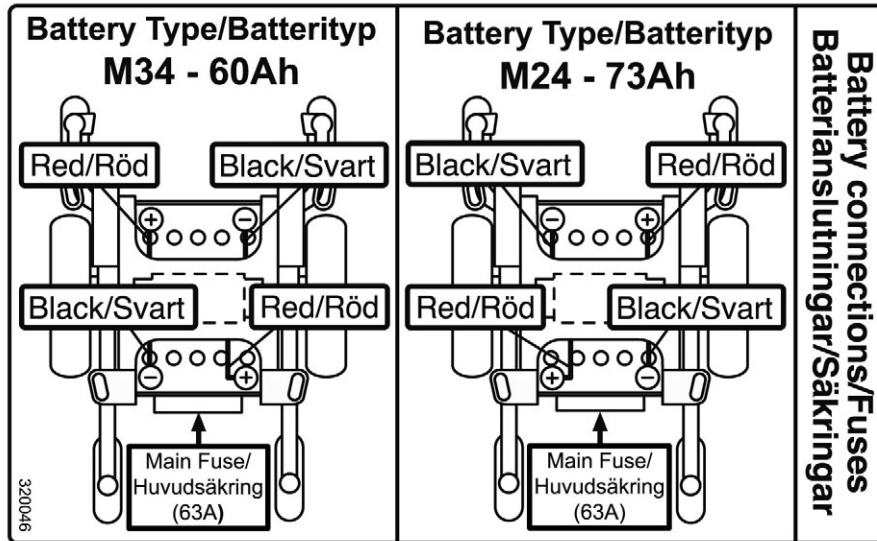

Figure 115. Battery Connections and Fuses.

Serial number label

1. Made in (country of final assembly) by (address of site of final assembly)
2. Serial number
3. Product type
4. Date of assembly
5. EAN code
6. Maximum user weight

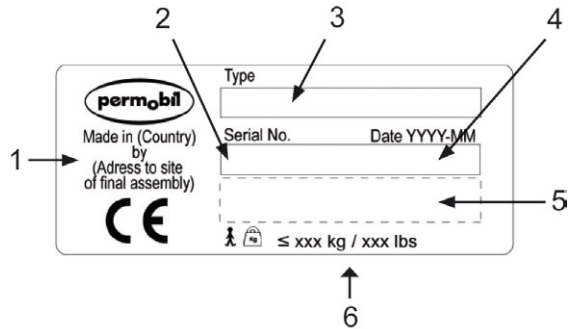

Figure 116. Serial number label.

INDEX**A**

Accessories	127
Airtransport.....	109

B

Batteries.....	37
Batteries – Charging.....	101
Batteries – Replacement.....	124
Batteries – Storage.....	115

C

Charging	101
Circuit Breaker	38
Cleaning.....	117

D

Drive wheels	119
Driving rules	93
Driving technique	92

G

General - Driving.....	90
------------------------	----

J

Joystick Error.....	91
---------------------	----

L

Lights.....	36
-------------	----

M

Manual brake release	98
----------------------------	----

P

Pivot Wheels.....	121
Positioning Belt.....	118

R

Reflectors.....	36
Resetcircuitbreaker	126

S

Safety Instructions.....	13
Stickers	151

T

Technical Specifications.....	129
Toolbag	113
Transport.....	106
Troubleshooting guide	134

www.permobil.com

permobil



205266-UK-0