

Fitting / Order form

M3 Corpus

Prices valid from: 10/4/2023



M3 Corpus

Mid wheel drive power chair with smooth suspension
 As standard, equipped with pneumatic or solid tyres, 65ah maintenance free batteries, charger and 10km/h top speed
 The M3 Corpus is prepared to be equipped with bio-mechanical powered backrest, elevating and articulating leg rests, seat elevation & anterior / posterior tilt power functions. The M3 can be accessorised with the direct mount ROHO Agility Backs and Bodilink postural management aids

Dealer information	
Customer (name / code)	/
Contact	
Address	
Post code / City	/
Phone / Fax	/
Client Information	
Name	/
Address	
Post code / City	/
Phone	
E-mail	

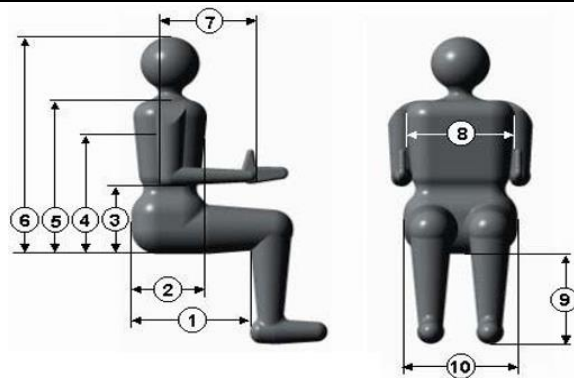

Anatomic Dimension

Diagnosis	Weight:	kg	3:	cm	7:	cm
	Height:	cm	4:	cm	8:	cm
			1:	cm	5:	cm
			2:	cm	6:	cm
					9:	cm
					10:	cm

Fitting date							<input checked="" type="checkbox"/> Required choice <input type="checkbox"/> / <input type="radio"/> Optional choice <input type="checkbox"/> / <input checked="" type="radio"/> Default required option	
Fitting date (dd-mm-yyyy)	Article code	Position Left Right	Price excl VAT	Price incl VAT	Funding code	Additional Info		

Chassis							
M3 CORPUS	109052-99-0	<input checked="" type="checkbox"/>	7314.00				
ESP <input type="radio"/>							
ESP GYRO M-SERIES	109643-99-0	<input type="checkbox"/>	1027.00				
Connect-Me (requires a signed consent form)							
CONNECTME 4G EU, ACTIVATED	109465-99-0	<input type="checkbox"/>	0.00				





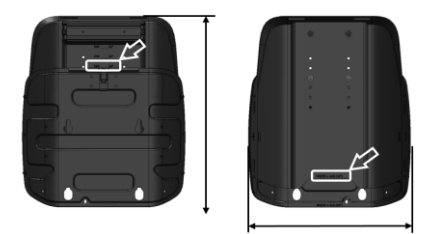





Accent colour		<input type="radio"/>		
Chassis / Wheels (no charge)				
COVER ACCENT COLOUR AQUA	109083-99-0	<input type="radio"/>	<input type="radio"/>	0.00
COVER ACCENT COLOUR SKY	109084-99-0	<input type="radio"/>	<input type="radio"/>	0.00
COVER ACCENT COLOUR VIOLET	109085-99-0	<input type="radio"/>	<input type="radio"/>	0.00
COVER ACCENT COLOUR FLAMINGO	109086-99-0	<input type="radio"/>	<input type="radio"/>	0.00
COVER ACCENT COLOUR CHILI	109087-99-0	<input type="radio"/>	<input type="radio"/>	0.00
COVER ACCENT COLOUR CANARY	109088-99-0	<input type="radio"/>	<input type="radio"/>	0.00
COVER ACCENT COLOUR SPRING	109089-99-0	<input type="radio"/>	<input type="radio"/>	0.00
COVER ACCENT COLOUR ARCTIC	109090-99-0	<input type="radio"/>	<input type="radio"/>	0.00
COVER ACCENT COLOUR SUNSET	109091-99-0	<input type="radio"/>	<input type="radio"/>	0.00
COVER ACCENT COLOUR MIDNIGHT BLACK	109176-99-0	<input type="radio"/>	<input type="radio"/>	0.00
COVER ACCENT COLOUR GOLD	109092-99-0	<input type="radio"/>	<input type="radio"/>	143.00
COVER ACCENT COLOUR BRONZE	109093-99-0	<input type="radio"/>	<input type="radio"/>	143.00
COVER ACCENT COLOUR PLATINUM	109094-99-0	<input type="radio"/>	<input type="radio"/>	143.00
Drive wheels				
WHEELS 3.00x8" AIR FILLED TIRES BLACK	108411-99-0	<input checked="" type="radio"/>	<input type="radio"/>	0.00
WHEELS 3.00x8" SOLID TIRES BLACK	108414-99-0	<input type="radio"/>	<input type="radio"/>	0.00
WHEELS 3.00x8" AIR FILLED TIRES/SNOW AND MUD BLACK	108412-99-0	<input type="radio"/>	<input type="radio"/>	0.00
 107289-99-0 107854-99-0 107855-99-0				
Batteries				
BATTERIES, 65Ah, SET OF 2 PERMOBIL	109183-99-0	<input checked="" type="radio"/>	<input type="radio"/>	0.00
BATTERIES, 85Ah, SET OF 2 PERMOBIL UPCHARGE	109307-99-0	<input type="radio"/>	<input type="radio"/>	159.00
WITHOUT BATTERIES	100661-99-0	<input type="radio"/>	<input type="radio"/>	0.00
Charger				
WITHOUT CHARGER	100662-99-0	<input type="radio"/>	<input type="radio"/>	0.00
CHARGER VOLTPRO 24/10 PER MOBIL GEL-AGM IP44 GB	109165-99-0	<input checked="" type="radio"/>	<input type="radio"/>	0.00
Light kit				
REFLECTOR KIT	108415-99-0	<input checked="" type="radio"/>	<input type="radio"/>	0.00
LIGHT KIT	109375-99-0	<input type="radio"/>	<input type="radio"/>	435.00
Accessories chassis				
LUGGAGE CARRIER WITH TAIL LIGHTS	109169-99-0	<input type="radio"/>	<input type="radio"/>	525.00
LUGGAGE CARRIER WITH REFLECTORS	109170-99-0	<input type="radio"/>	<input type="radio"/>	313.00
WITHOUT LUGGAGE CARRIER	109284-99-0	<input checked="" type="radio"/>	<input type="radio"/>	0.00
PREPARED FOR DAHL CARLOCK	108254-99-0	<input type="radio"/>	<input type="radio"/>	167.00
MOUNTDAHL LOCKING PLATE	109019-99-0	<input type="radio"/>	<input type="radio"/>	557.00
OPTION NOT REQUIRED		<input checked="" type="radio"/>	<input type="radio"/>	
RUNNING TIME METER	107853-99-0	<input type="radio"/>	<input type="radio"/>	157.00
RUNNING TIME METER (NO LUGGAGE CARRIER)	107893-99-0	<input type="radio"/>	<input type="radio"/>	157.00
OPTION NOT REQUIRED		<input checked="" type="radio"/>	<input type="radio"/>	
REMOTE STOP	108526-99-0	<input type="checkbox"/>	<input type="checkbox"/>	604.00
TARPAULIN/RAINCOVER FOR ALL MODLES (NYLON)	101888-99-0	<input type="radio"/>	<input type="radio"/>	138.00
RUNNING TIME METER (NO LUGGAGE CARRIER)	107893-99-0	<input type="radio"/>	<input type="radio"/>	157.00
OPTION NOT REQUIRED	101897-99-0	<input checked="" type="radio"/>	<input type="radio"/>	
				

Seat assembly									
SEAT HEIGHT FIXED	107097-99-0	<input checked="" type="checkbox"/>	0.00						
POWERED SEAT LIFT	107098-99-0	<input type="checkbox"/>	848.00						
FIXED SEAT ANGEL	107096-99-0	<input checked="" type="checkbox"/>	0.00						
POWERED ADJ.SEAT TILT 50°	107095-99-0	<input type="checkbox"/>	1961.00						
WITHOUT ANTERIOR/NEGATIVE SEAT TILT	107093-99-0	<input checked="" type="checkbox"/>	0.00						
5° ACTIVE SEATING	107099-99-0	<input type="checkbox"/>	0.00						
10° ACTIVE SEATING	107090-99-0	<input type="checkbox"/>	0.00						
20° ACTIVE SEATING (REQ. LEGREST(X)+KNEESUPPORT)	107091-99-0	<input type="checkbox"/>	0.00						
Seat									
SEAT CORPUS	107022-99-0	<input checked="" type="checkbox"/>	0.00						
Seat sizes									
	Depth								
Size (mm)	370	395	420	445	470	495	520	545	570
Width	420	<input type="checkbox"/>	<input type="checkbox"/>	<input type="checkbox"/>	<input type="checkbox"/>	<input type="checkbox"/>	<input type="checkbox"/>	<input type="checkbox"/>	<input type="checkbox"/>
	470	<input type="checkbox"/>	<input type="checkbox"/>	<input checked="" type="checkbox"/>	<input type="checkbox"/>	<input type="checkbox"/>	<input type="checkbox"/>	<input type="checkbox"/>	<input type="checkbox"/>
	520	<input type="checkbox"/>	<input type="checkbox"/>	<input type="checkbox"/>	<input type="checkbox"/>	<input type="checkbox"/>	<input type="checkbox"/>	<input type="checkbox"/>	<input type="checkbox"/>
	570	<input type="checkbox"/>	<input type="checkbox"/>	<input type="checkbox"/>	<input type="checkbox"/>	<input type="checkbox"/>	<input type="checkbox"/>	<input type="checkbox"/>	<input type="checkbox"/>
Seat cushion									
SEAT CUSHION VINYL	10XXXX-99-0	<input checked="" type="checkbox"/>	0.00						
SEAT CUSHION STRETCH AIR	10XXXX-99-0	<input type="checkbox"/>	0.00						
WITHOUT SEAT CUSHION	105118-99-0	<input type="checkbox"/>	-101.00						
ERGO SUPPORTS SEAT CUSHION	105219-99-0	<input checked="" type="checkbox"/>	0.00						
Adjustment backrest									
POWERED ADJ. BACKREST 150° (LA28)	107825-99-0	<input type="checkbox"/>	1166.00						
POWERED ADJ. BACKREST 180° (LA28)	107755-99-0	<input type="checkbox"/>	1166.00						
MANUAL ADJUST. BACKREST	108195-99-0	<input checked="" type="checkbox"/>	0.00						
BACKREST FIXED	105066-99-0	<input checked="" type="checkbox"/>	0.00						
BACKREST BIO-MECH	105067-99-0	<input type="checkbox"/>	742.00						
Backrest type									
SHORT	107262-99-0	<input type="checkbox"/>	0.00						
STANDARD	107264-99-0	<input checked="" type="checkbox"/>	0.00						
DIRECT BACKREST ADAPTER	107261-99-0	<input type="checkbox"/>	435.00						
TUBELAR BACKREST ADAPTER	107265-99-0	<input type="checkbox"/>	477.00						
WITHOUT BACKREST SHELL	107272-99-0	<input type="checkbox"/>	-133.00						
Backrest sizes									
	Short	Standard heights							
Size (mm)	470	545	570	595	620	645	670		
Width	360	<input type="checkbox"/>	<input type="checkbox"/>	<input type="checkbox"/>	<input type="checkbox"/>	<input type="checkbox"/>	<input type="checkbox"/>		
	410	<input type="checkbox"/>	<input type="checkbox"/>	<input type="checkbox"/>	<input checked="" type="checkbox"/>	<input type="checkbox"/>	<input type="checkbox"/>		
	460	<input type="checkbox"/>	<input type="checkbox"/>	<input type="checkbox"/>	<input type="checkbox"/>	<input type="checkbox"/>	<input type="checkbox"/>		
	510	<input type="checkbox"/>	<input type="checkbox"/>	<input type="checkbox"/>	<input type="checkbox"/>	<input type="checkbox"/>	<input type="checkbox"/>		
Backrest cushion									
BACKREST CUSHION VINYL	10XXXX-99-0	<input checked="" type="checkbox"/>	0.00						
BACKREST CUSHION STRETCH AIR	10XXXX-99-0	<input type="checkbox"/>	0.00						
WITHOUT BACKREST CUSHION	105117-99-0	<input type="checkbox"/>	-101.00						

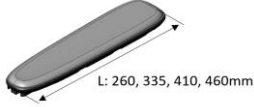

ERGO SUPPORTS BACK SMALL (5 CM DEEP)	105569-99-0		0.00
ERGO SUPPORTS BACK LARGE (7 CM DEEP)	105570-99-0		0.00

	109157-99-0
---	-------------

Agility Max Contour											
		(H) Height			(MH)	Mounting height					
(W)	Size ("/mm)	16"	18"	20"		16"	18"	20"			
Width	14"/355mm	<input type="radio"/>	<input type="radio"/>	<input type="radio"/>		470mm	<input type="radio"/>			890.00	
	15"/380mm	<input type="radio"/>	<input type="radio"/>	<input type="radio"/>		495mm	<input type="radio"/>				
	16"/405mm	<input type="radio"/>	<input type="radio"/>	<input type="radio"/>		520mm	<input type="radio"/>	<input type="radio"/>			
	17"/430mm	<input type="radio"/>	<input type="radio"/>	<input type="radio"/>		545mm	<input type="radio"/>	<input type="radio"/>	<input type="radio"/>		
	18"/455mm	<input type="radio"/>	<input type="radio"/>	<input type="radio"/>		570mm	<input type="radio"/>	<input type="radio"/>	<input type="radio"/>		
	19"/485mm	<input type="radio"/>	<input type="radio"/>	<input type="radio"/>		595mm	<input type="radio"/>	<input type="radio"/>	<input type="radio"/>		
	20"/510mm	<input type="radio"/>	<input type="radio"/>	<input type="radio"/>		620mm		<input type="radio"/>	<input type="radio"/>		
OPTION NOT REQUIRED			<input checked="" type="radio"/>			645mm			<input type="radio"/>		
											
Height Agility lateral supports											
AGILITY LATERAL SUPPORTS LOW POSITION (STANDARD)		108538-99-0		<input checked="" type="radio"/>		0.00					
AGILITY LATERAL SUPPORTS HIGH POSITION		108537-99-0		<input type="radio"/>		0.00					
Mounting armrests											
WIDTH BETWEEN ARMRESTS: NARROW (38-48CM)		107251-99-0		<input checked="" type="radio"/>		0.00					
WIDTH BETWEEN ARMRESTS: WIDE (48-58CM)		107252-99-0		<input type="radio"/>		0.00					
WIDTH BETWEEN ARMRESTS SET TO 380MM		105083-99-0		<input type="radio"/>		0.00					
WIDTH BETWEEN ARMRESTS SET TO 430MM		105084-99-0		<input checked="" type="radio"/>		0.00					
WIDTH BETWEEN ARMRESTS SET TO 480MM		105085-99-0		<input type="radio"/>		0.00					
WIDTH BETWEEN ARMRESTS SET TO 530MM		105086-99-0		<input type="radio"/>		0.00					
WIDTH BETWEEN ARMRESTS SET TO 580MM		105082-99-0		<input type="radio"/>		0.00					
ARMREST HEIGHT POS 1: 230MM (FROM SEAT PAN)		106631-99-0		<input type="radio"/>		0.00					
ARMREST HEIGHT POS 2: 255MM (FROM SEAT PAN)		106632-99-0		<input type="radio"/>		0.00					
ARMREST HEIGHT POS 3: 280MM (FROM SEAT PAN)		106633-99-0		<input checked="" type="radio"/>		0.00					
ARMREST HEIGHT POS 4: 305MM (FROM SEAT PAN)		106634-99-0		<input type="radio"/>		0.00					
ARMREST HEIGHT POS 5: 330MM (FROM SEAT PAN)		106635-99-0		<input type="radio"/>		0.00					
ARMREST HOLDERS FIXED		105070-99-0		<input checked="" type="radio"/>		0.00					
ARMREST HOLDERS SWIVEL		105072-99-0		<input type="radio"/>		180.00					
Armrests											
		Left				Right					
		260	335	410	460	260	335	410	460		
WITHOUT ARMREST		<input type="radio"/>	<input type="radio"/>	<input type="radio"/>	<input type="radio"/>	<input type="radio"/>	<input type="radio"/>	<input type="radio"/>	<input type="radio"/>	-45.00	
TEXTILE ARMREST		<input type="radio"/>	<input type="radio"/>	<input type="radio"/>	<input type="radio"/>	<input type="radio"/>	<input type="radio"/>	<input type="radio"/>	<input type="radio"/>	0.00	
VINYL ARMREST		<input type="radio"/>	<input checked="" type="radio"/>	<input type="radio"/>	<input type="radio"/>	<input type="radio"/>	<input checked="" type="radio"/>	<input type="radio"/>	<input type="radio"/>	0.00	
GEL ARMREST		<input type="radio"/>	<input type="radio"/>	<input type="radio"/>	<input type="radio"/>	<input type="radio"/>	<input type="radio"/>	<input type="radio"/>	<input type="radio"/>	148.00	
MOLDED ARMREST LEFT		108860-99-0				<input type="checkbox"/>				159.00	
MOLDED ARMREST RIGHT		108861-99-0					<input type="checkbox"/>				159.00
MOLDED HAND PAD MEDIUM LEFT		108862-99-0				<input type="radio"/>				64.00	
MOLDED HAND PAD LARGE LEFT		108864-99-0				<input type="radio"/>				64.00	
OPTION NOT REQUIRED						<input checked="" type="radio"/>					
MOLDED HAND PAD MEDIUM RIGHT		108863-99-0					<input type="radio"/>				64.00
MOLDED HAND PAD LARGE RIGHT		108865-99-0					<input type="radio"/>				64.00
OPTION NOT REQUIRED							<input checked="" type="radio"/>				
											
											

Adjustment legrest						
POWERED ADJ. LEGREST CORPUS (LA28)	107757-99-0	<input type="radio"/>	1378.00			
POWERED ADJ. LEGREST CORPUS POW EXT LEG (LA28)	107758-99-0	<input type="radio"/>	1378.00			
MANUAL ADJUSTMENT LEGREST (BRACKET LA28)	107763-99-0	<input checked="" type="radio"/>	0.00			
Legrest						
LEGREST W. 205MM LENGTH COMPENSATION	107012-99-0	<input checked="" type="radio"/>	0.00			
LEGREST W. 185MM LENGTH COMPENSATION	107184-99-0	<input type="radio"/>	0.00			
LEGREST WITH POW. LENGTH COMPENSATION 20CM (X)	107185-99-0	<input type="radio"/>	1166.00			
LEGREST W. 32-41(+10)CM HEIGHT ADJ. FOOTPL.	107219-99-0	<input type="radio"/>	2067.00			
LEGREST W. 35-44(+10)CM HEIGHT ADJ. FOOTPL.	107220-99-0	<input type="radio"/>	2067.00			
WITHOUT LEGREST	105760-99-0	<input type="radio"/>	0.00			
Footplates						
DUAL FOOTPLATE 16CM LEG LENGTH 29-50CM AL.	105436-99-0	<input checked="" type="radio"/>	0.00			
DUAL FOOTPLATE 20CM LEG LENGTH 29-50CM	105437-99-0	<input type="radio"/>	0.00			
FOOTPLATE 1 PIECE LEG LENGTH 29-50CM	106760-99-0	<input type="radio"/>	0.00			
DUAL FOOTPLATE 16CM LEG LENGTH 14-30CM AL.	105438-99-0	<input type="radio"/>	0.00			
DUAL FOOTPLATE 20CM LEG LENGTH 14-30CM	105439-99-0	<input type="radio"/>	0.00			
DUAL FOOTPLATE 16CM LEG LENGTH 25-50CM (PWR)	106967-99-0	<input type="radio"/>	0.00			
FOOTPLATE 1P. 42CM LEG LENGTH 25-50CM (PWR FOOT)	106969-99-0	<input type="radio"/>	0.00			
DUAL FOOTPLATE 20CM LEG LENGTH 25-50CM (PWR FOOT)	106971-99-0	<input type="radio"/>	0.00			
DUAL FOOTPLATE 16CM LEG LENGTH <25CM (PWR)	106966-99-0	<input type="radio"/>	0.00			
DUAL FOOTPLATE 20CM LEG LENGTH <25CM (PWR FOOT)	106970-99-0	<input type="radio"/>	0.00			
FOOTPLATE 1P. 42CM LEG LENGTH <25CM (PWR FOOT)	106968-99-0	<input type="radio"/>	0.00			
DUAL FOOTPLATE 16CM	107453-99-0	<input type="radio"/>	0.00			
DUAL FOOTPLATE 20CM	106008-99-0	<input type="radio"/>	0.00			
FOOTPLATE CHOICE NOT REQUIRED	106154-99-0	<input type="radio"/>	0.00			

Accessories seat

Headrest

HEAD SUPPORT, ADJUSTABLE TEXTILE(BLACK)	106336-99-0	<input type="radio"/>	235.00		
HEAD SUPPORT, ADJUSTABLE TEXTILE(BLACK)/SHORT BACK	106337-99-0	<input type="radio"/>	235.00		
HEAD SUPPORT, ADJUSTABLE VINYL	106331-99-0	<input type="radio"/>	235.00		
HEAD SUPPORT, ADJUSTABLE VINYL/SHORT BACK	106338-99-0	<input type="radio"/>	220.00		
HEAD SUPPORT "ERGO" TEXTILE(BLACK)	106333-99-0	<input type="radio"/>	235.00		
HEAD SUPPORT "ERGO" TEXT. (BLACK) SHORT BACK	106335-99-0	<input type="radio"/>	235.00		
HEAD SUPPORT "ERGO"	106332-99-0	<input type="radio"/>	235.00		
HEAD SUPPORT "ERGO" SHORT BACK	106334-99-0	<input type="radio"/>	235.00		
<hr/>					
HEADREST ORIGINAL 340x130 LONG HOLDER, STD BACK	107716-99-0	<input type="radio"/>	371.00		
HEADREST ORIGINAL 340x130 LONG HOLDER, SHORT BACK	107715-99-0	<input type="radio"/>	371.00		
HEADREST ORIGINAL 340x130 STD HOLDER, STD BACK	107718-99-0	<input type="radio"/>	371.00		
HEADREST ORIGINAL 340x130 STD HOLDER, SHORT BACK	107717-99-0	<input type="radio"/>	371.00		
HEADREST ORIGINAL 250x125 LONG HOLDER, STD BACK	107708-99-0	<input type="radio"/>	371.00		
HEADREST ORIGINAL 250x125 LONG HOLDER, SHORT BACK	107719-99-0	<input type="radio"/>	371.00		
HEADREST ORIGINAL 250x125 STD HOLDER, STD BACK	107710-99-0	<input type="radio"/>	371.00		
HEADREST ORIGINAL 250x125 STD HOLDER, SHORT BACK	107709-99-0	<input type="radio"/>	371.00		
HEADREST ORIGINAL 180x110 LONG HOLDER, STD BACK	107712-99-0	<input type="radio"/>	371.00		
HEADREST ORIGINAL 180x110 LONG HOLDER, SHORT BACK	107711-99-0	<input type="radio"/>	371.00		
HEADREST ORIGINAL 180x110 STD HOLDER, STD BACK	107714-99-0	<input type="radio"/>	371.00		
HEADREST ORIGINAL 180x110 STD HOLDER, SHORT BACK	107713-99-0	<input type="radio"/>	371.00		
HEADREST ORIGINAL 180x110 STD HOLDER, AGILITY	108579-99-0	<input type="radio"/>	371.00		
HEADREST ORIGINAL 180x110 LONG HOLDER, AGILITY	108580-99-0	<input type="radio"/>	371.00		
HEADREST ORIGINAL 250x125 STD HOLDER, AGILITY	108581-99-0	<input type="radio"/>	371.00		
HEADREST ORIGINAL 250x125 LONG HOLDER, AGILITY	108582-99-0	<input type="radio"/>	371.00		
HEADREST ORIGINAL 340x130 STD HOLDER, AGILITY	108583-99-0	<input type="radio"/>	371.00		
HEADREST ORIGINAL 340x130 LONG HOLDER, AGILITY	108584-99-0	<input type="radio"/>	371.00		
<hr/>					
BODILINK HEADREST L MAX 8 STD BACK	108719-99-0	<input type="radio"/>	419.00		
BODILINK HEADREST L MAX 8 LOW BACK	108720-99-0	<input type="radio"/>	419.00		
BODILINK HEADREST M MAX 8 STD BACK	108717-99-0	<input type="radio"/>	419.00		
BODILINK HEADREST M MAX 8 LOW BACK	108718-99-0	<input type="radio"/>	419.00		
BODILINK HEADREST S MAX 8 STD BACK	109003-99-0	<input type="radio"/>	419.00		
BODILINK HEADREST S MAX 8 LOW BACK	109004-99-0	<input type="radio"/>	419.00		
<hr/>					
OPTION NOT REQUIRED		<input checked="" type="radio"/>			



Facial support pad / switch Left

SWING AWAY FACIAL SUPPORT STANDARD LEFT/HIGH	107860-99-0	<input type="radio"/>	350.00		
SWING AWAY FACIAL SUPPORT LONG LEFT/HIGH	107861-99-0	<input type="radio"/>	350.00		
SWING AWAY ASSY W. EGG SW F. HEADREST LEFT/HIGH	107858-99-0	<input type="radio"/>	435.00		
SWING AWAY ASSY W. TASH MICRO LIGHT LEFT/HIGH	107859-99-0	<input type="radio"/>	496.00		
OPTION NOT REQUIRED		<input checked="" type="radio"/>			



Facial support pad / switch Right

SWING AWAY FACIAL SUPPORT STANDARD RIGHT/HIGH	107941-99-0	<input type="radio"/>	350.00		
SWING AWAY FACIAL SUPPORT LONG RIGHT/HIGH	107944-99-0	<input type="radio"/>	350.00		
SWING AWAY ASSY W. EGG SW F. HEADREST RIGHT/HIGH	107931-99-0	<input type="radio"/>	471.00		
SWING AWAY ASSY W. TASH MICRO LIGHT RIGHT/HIGH	107935-99-0	<input type="radio"/>	496.00		



OPTION NOT REQUIRED

<input type="checkbox"/>	<input type="checkbox"/>	<input type="checkbox"/>	<input type="checkbox"/>	<input type="checkbox"/>
--------------------------	--------------------------	--------------------------	--------------------------	--------------------------



Extension cable					
EXTENSION CABLE 3MM STEREO, L=1M	105931-99-0	○		52.00	
EXTENSION CABLE 3MM STEREO, L=2M	105932-99-0	○		52.00	
OPTION NOT REQUIRED		●			
Lateral support					
BODILINK LATERAL SUPP. L. STRETCH-AIR 75X140	109025-99-0	○		265.00	
BODILINK LATERAL SUPP. L. STRETCH-AIR 100X165	109027-99-0	○		265.00	
BODILINK LATERAL SUPP. R. STRETCH-AIR 75X140	109026-99-0		○	265.00	
BODILINK LATERAL SUPP. R. STRETCH-AIR 100X165	109028-99-0		○	265.00	
LATERAL SUPPORT ORIGINAL LEFT 180X130	107720-99-0	○		239.00	
LATERAL SUPPORT ORIGINAL LEFT 130X80	107722-99-0	○		239.00	
LATERAL SUPPORT ORIGINAL RIGHT 180X130	107721-99-0		○	239.00	
LATERAL SUPPORT ORIGINAL RIGHT 130X80	107723-99-0		○	239.00	
OPTION NOT REQUIRED		●	●		
Thigh supports					
BODILINK THIGH SUPPORT L. STRETCH-AIR 90X110 S(B)	109179-99-0	○		207.00	
BODILINK THIGH SUPPORT L. STRETCH-AIR 200X90 L(C)	109181-99-0	○		207.00	
BODILINK THIGH SUPPORT L. STRETCH-AIR 300x90 XL(G)	109036-99-0	○		207.00	
BODILINK THIGH SUPPORT R. STRETCH-AIR 90X110 S(B)	109180-99-0		○	207.00	
BODILINK THIGH SUPPORT R. STRETCH-AIR 200X90 L(C)	109182-99-0		○	207.00	
BODILINK THIGH SUPPORT R. STRETCH-AIR 300x90 XL(G)	109037-99-0		○	207.00	
THIGH SUPPORT LEFT TEXT. (MESH) 110x90 SMALL (B)	107392-99-0	○		159.00	
THIGH SUPPORT LEFT TEXT. (MESH) 165x120 MEDIUM (J)	107396-99-0	○		159.00	
THIGH SUPPORT LEFT TEXT. (MESH) 200x90 LARGE (C)	107394-99-0	○		159.00	
THIGH SUPPORT LEFT TEXT. (MESH) 300x90 XLARGE (G)	107390-99-0	○		159.00	
THIGH SUPPORT RIGHT TEXT. (MESH) 110x90 SMALL (B)	107393-99-0		○	159.00	
THIGH SUPPORT RIGHT TEXT. (MESH) 165x120 MEDIUM (J)	107397-99-0		○	159.00	
THIGH SUPPORT RIGHT TEXT. (MESH) 200x90 LARGE (C)	107395-99-0		○	159.00	
THIGH SUPPORT RIGHT TEXT. (MESH) 300x90 XLARGE (G)	107391-99-0		○	159.00	
OPTION NOT REQUIRED		●	●		
Hip supports					
BODILINK HIP SUPPORT L. STRETCH-AIR 90X110 S(B)	109032-99-0	○		207.00	
BODILINK HIP SUPPORT L. STRETCH-AIR 200X90 L(C)	109034-99-0	○		207.00	
BODILINK HIP SUPPORT L. STRETCH-AIR 150X140 M(A)	109038-99-0	○		207.00	
BODILINK HIP SUPPORT R. STRETCH-AIR 90X110 S(B)	109033-99-0		○	207.00	
BODILINK HIP SUPPORT R. STRETCH-AIR 200X90 L(C)	109035-99-0		○	207.00	
BODILINK HIP SUPPORT R. STRETCH-AIR 150X140 M(A)	109039-99-0		○	207.00	
HIP SUPPORT LEFT TEXT. (MESH) 110x90 SMALL (B)	107400-99-0	○		159.00	
HIP SUPPORT LEFT TEXT. (MESH) 150x140 MEDIUM (A)	107398-99-0	○		159.00	
HIP SUPPORT LEFT TEXT. (MESH) 200x90 LARGE (C)	107402-99-0	○		159.00	
HIP SUPPORT LEFT TEXT. (MESH) 200x200 XLARGE (D)	107404-99-0	○		159.00	
HIP SUPPORT RIGHT TEXT. (MESH) 110x90 SMALL (B)	107401-99-0		○	159.00	
HIP SUPPORT RIGHT TEXT. (MESH) 150x140 MEDIUM (A)	107399-99-0		○	159.00	
HIP SUPPORT RIGHT TEXT. (MESH) 200x90 LARGE (C)	107403-99-0		○	159.00	
HIP SUPPORT RIGHT TEXT. (MESH) 200x200 XLARGE (D)	107405-99-0		○	159.00	
OPTION NOT REQUIRED		●	●		

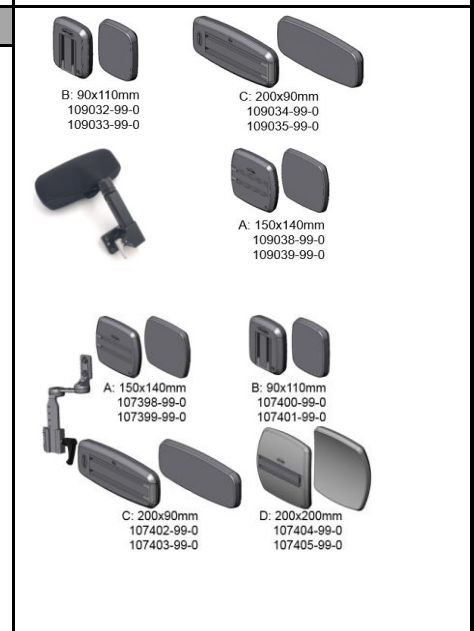
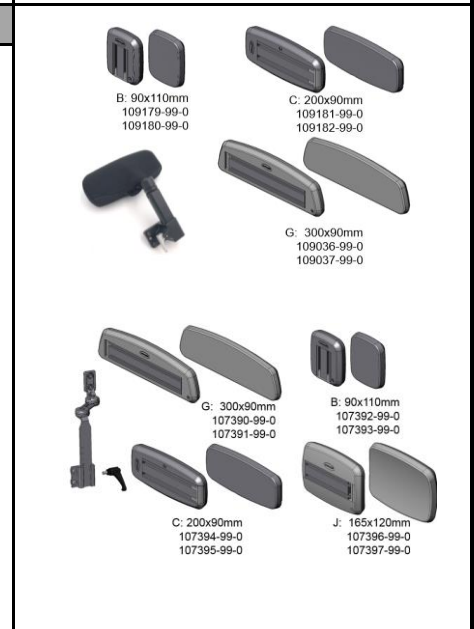
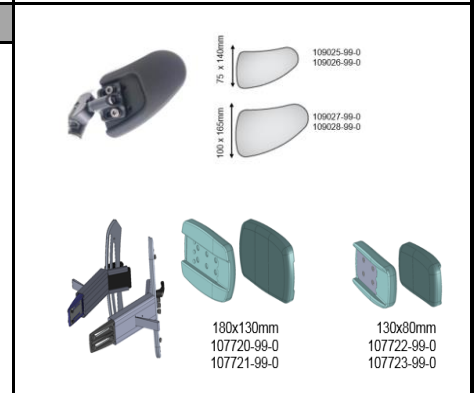

Calf supports					
CALF SUPPORTS S (B) 110x90 (MESH)	105252-99-0	<input type="radio"/>		254.00	
CALF SUPPORTS M (J) 165x120 (MESH)	105258-99-0	<input type="radio"/>		254.00	
CALF SUPPORTS L (A) 150x140 (MESH)	105250-99-0	<input type="radio"/>		254.00	
CALF SUPPORTS XL (H) 170x175 (MESH)	105256-99-0	<input type="radio"/>		254.00	
CALF SUPPORTS XXL (D) 200x200 (MESH)	105254-99-0	<input type="radio"/>		254.00	
CALF SUPPORTS S (B) 110x90 (MESH) (VS/HD)	107210-99-0	<input type="radio"/>		254.00	
CALF SUPPORTS M (J) 165x120 (MESH) (VS/HD)	107211-99-0	<input type="radio"/>		254.00	
CALF SUPPORTS L (A) 150x140 (MESH) (VS/HD)	106190-99-0	<input type="radio"/>		254.00	
CALF SUPPORTS XL (H) 170x175 (MESH) (VS/HD)	106188-99-0	<input type="radio"/>		254.00	
CALF SUPPORTS XXL (D) 200x200 (MESH) (VS/HD)	106186-99-0	<input type="radio"/>		254.00	
OPTION NOT REQUIRED		<input checked="" type="radio"/>			
<p>A: 150x140mm 105250-99-0 106190-99-0</p> <p>D: 200x200mm 105254-99-0 106186-99-0</p> <p>J: 165x120mm 106617-99-0 105258-99-0 107211-99-0</p> <p>B: 90x110mm 105252-99-0 107210-99-0</p> <p>H: 170x175mm 105256-99-0 106188-99-0</p>					
Elbow and side supports armrests					
ELBOW SUPPORT LEFT	107838-99-0	<input type="checkbox"/>		95.00	
ELBOW SUPPORT RIGHT	107839-99-0	<input type="checkbox"/>		95.00	
ARMREST SIDE SUPPORT LEFT OUTSIDE	107863-99-0	<input type="checkbox"/>		53.00	
ARMREST SIDE SUPPORT RIGHT OUTSIDE	107840-99-0	<input type="checkbox"/>		53.00	
ARMREST SIDE SUPPORT LEFT INSIDE	107865-99-0	<input type="checkbox"/>		53.00	
ARMREST SIDE SUPPORT RIGHT INSIDE	107864-99-0	<input type="checkbox"/>		53.00	
<p>107840-99-0 107863-99-0 107864-99-0 107865-99-0</p> <p>107838-99-0 107839-99-0</p>					
Gel pads footplates					
STEALTH GEL PADS 16CM WIDE FOOTPATES	106530-99-0	<input type="checkbox"/>		313.00	
STEALTH GEL PADS 20CM WIDE FOOTPATES	106225-99-0	<input type="checkbox"/>		313.00	
Abduction wedge					
ABDUCTION WEDGE	109373-99-0	<input type="checkbox"/>		307.00	
Shoulder support					
SHOULDER SUPPORT FOR 36CM WIDE BACKREST	105410-99-0	<input type="radio"/>		0.00	
SHOULDER SUPPORT FOR 41CM WIDE BACKREST	105411-99-0	<input type="radio"/>		0.00	
SHOULDER SUPPORT FOR 46CM WIDE BACKREST	105412-99-0	<input type="radio"/>		0.00	
SHOULDER SUPPORT FOR 51CM WIDE BACKREST	105854-99-0	<input type="radio"/>		0.00	
OPTION NOT REQUIRED		<input checked="" type="radio"/>			
<p>36cm: 105410-99-0 41cm: 105411-99-0 46cm: 105412-99-0 51cm: 105854-99-0</p>					
Stump supports					
STUMP SUPPORT SMALL (A) 150x140 TEXTILE (MESH)	106497-99-0	<input type="radio"/>	<input type="radio"/>	191.00	
STUMP SUPPORT MEDIUM (J) 165x120 TEXTILE (MESH)	106500-99-0	<input type="radio"/>	<input type="radio"/>	191.00	
STUMP SUPPORT LARGE (H) 170x175 TEXTILE (MESH)	106499-99-0	<input type="radio"/>	<input type="radio"/>	191.00	
STUMP SUPPORT XLARGE (D) 200x200 TEXTILE (MESH)	106498-99-0	<input type="radio"/>	<input type="radio"/>	191.00	
OPTION NOT REQUIRED		<input checked="" type="radio"/>	<input checked="" type="radio"/>		
<p>A: 150x140mm 103067-99-0</p> <p>J: 165x120mm 103068-99-0</p> <p>D: 200x200mm 103071-99-0</p> <p>H: 170x175mm 103070-99-0</p>					
Knee support					
KNEE SUPPORT WITH TEXTIEL UPHOLSTERY	107285-99-0	<input type="checkbox"/>		0.00	
HOLDER KNEE SUPPORT UNITRACK	107028-99-0	<input type="checkbox"/>		45.00	
<p>107285-99-0</p> <p>107028-99-0</p>					
Lumbar support					
LUMBAR SUPPORT,AIR	101972-99-0	<input type="checkbox"/>		191.00	
<p>101972-99-0</p>					

Seatbelts			
CHEST STRAP BODYPOINT ELASTIC LARGE	105843-99-0	<input type="radio"/>	80.00
CHEST STRAP BODYPOINT ELASTIC SMALL	105845-99-0	<input type="radio"/>	80.00
OPTION NOT REQUIRED		<input checked="" type="radio"/>	
SEATBELT, BODYPOINT 2- POINT, MEDIUM, NON-PADDED	104518-99-0	<input type="radio"/>	72.00
SEATBELT, BODYPOINT 2- POINT, LARGE, NON-PADDED	104514-99-0	<input type="radio"/>	72.00
SEATBELT, BODYPOINT 2- POINT, MEDIUM, PADDED	104520-99-0	<input type="radio"/>	103.00
SEATBELT, BODYPOINT 2- POINT, LARGE, PADDED	104516-99-0	<input type="radio"/>	103.00
BP HIP BELT, 2P C PULL LATCH 46CM PAD	108267-99-0	<input type="radio"/>	103.00
BP HIP BELT, 2P C PULL LATCH 62CM PAD	108266-99-0	<input type="radio"/>	103.00
BP HIP BELT, 4P R PULL PUSHBUTT. 46CM PAD	108265-99-0	<input type="radio"/>	139.00
SAFETY BELT,BUCKLE	100518-99-0	<input type="radio"/>	60.00
SAFETY BELT,AUTOTENSION	100519-99-0	<input type="radio"/> <input type="radio"/>	114.00
SAFETY BELT,AUTOTENSION LONG VERSION	100600-99-0	<input type="radio"/> <input type="radio"/>	114.00
OPTION NOT REQUIRED		<input checked="" type="radio"/>	
SAFETY BELT,4-POINT	100529-99-0	<input type="radio"/>	145.00
SEATBELT, BODYPOINT MONOFLEX MEDIUM	105840-99-0	<input type="radio"/>	87.00
SEATBELT, BODYPOINT MONOFLEX LARGE	105839-99-0	<input type="radio"/>	87.00
SEATBELT, BODYPOINT MONOFLEX X-LARGE	105850-99-0	<input type="radio"/>	87.00
BP HARNESS PIVOTFIT S SHOULDER SUPPORT FP	108275-99-0	<input type="radio"/>	154.00
BP HARNESS PIVOTFIT M SHOULDER SUPPORT FP	108276-99-0	<input type="radio"/>	154.00
BP HARNESS PIVOTFIT L SHOULDER SUPPORT FP	108277-99-0	<input type="radio"/>	154.00
BP HARNESS PIVOTFIT XL SHOULDER SUPPORT FP	108278-99-0	<input type="radio"/>	154.00
BP HARNESS STAYFLEX XS CHEST SUPPORT FP	108269-99-0	<input type="radio"/>	154.00
BP HARNESS STAYFLEX S CHEST SUPPORT FP	108270-99-0	<input type="radio"/>	154.00
BP HARNESS STAYFLEX M CHEST SUPPORT FP	108271-99-0	<input type="radio"/>	154.00
BP HARNESS STAYFLEX L CHEST SUPPORT FP	108272-99-0	<input type="radio"/>	154.00
BP HARNESS STAYFLEX XL CHEST SUPPORT FP	108273-99-0	<input type="radio"/>	154.00
OPTION NOT REQUIRED		<input checked="" type="radio"/>	
FOOTSTRAPS WITH PADS (SET OF 2)	103104-99-0	<input type="radio"/>	127.00
FOOTSTRAPS WITHOUT PADS (SET OF 2)	103427-99-0	<input type="radio"/>	42.00
BP ANKEL HUGGERS MEDIUM	108242-99-0	<input type="radio"/>	147.00
BP ANKEL HUGGERS LARGE	108243-99-0	<input type="radio"/>	147.00
OPTION NOT REQUIRED		<input checked="" type="radio"/>	
Alternative seat cushions / options			
INCONTINENCE PROTECTIVE COVER		0 <input type="button" value="v"/>	140.00
SEAT CUSHION ERGO AIR		<input type="checkbox"/>	583.00
ROHO QUADRO SELECT (Prices starting from)		<input type="checkbox"/>	#N/A
ROHO CONTOUR (Prices starting from)		<input type="checkbox"/>	#N/A
ROHO HYBRID ELITE (Prices starting from)		<input type="checkbox"/>	#N/A



Tray tables					
TABLE,SWING AWAY 550MM FOR JOYSTICK L/R	109325-99-0	<input type="radio"/>	<input type="radio"/>	371.00	
TABLE,SWING AWAY 600MM FOR JOYSTICK L/R	105262-99-0	<input type="radio"/>	<input type="radio"/>	371.00	
TABLE,SWING AWAY 650MM FOR JOYSTICK L/R	105263-99-0	<input type="radio"/>	<input type="radio"/>	371.00	
TABLE,SWING AWAY 600MM FOR JOYSTICK CENTER	105264-99-0	<input type="radio"/>	<input type="radio"/>	0.00	
TABLE,SWING AWAY 650MM FOR JOYSTICK CENTER	105261-99-0	<input type="radio"/>	<input type="radio"/>	0.00	
OPTION NOT REQUIRED		<input checked="" type="checkbox"/>			
TABLE,REMOVABLE ANGLE ADJ LEFT, WIDTH 330MM	108510-99-0	<input type="radio"/>		318.00	
TABLE,REMOVABLE ANGLE ADJ RIGHT, WIDTH 330MM	108505-99-0		<input type="radio"/>	318.00	
TABLE,REMOVABLE ANGLE ADJ LEFT, WIDTH 380MM	108511-99-0	<input type="radio"/>		318.00	
TABLE,REMOVABLE ANGLE ADJ RIGHT, WIDTH 380MM	108506-99-0		<input type="radio"/>	318.00	
TABLE,REMOVABLE ANGLE ADJ LEFT, WIDTH 430MM	108512-99-0	<input type="radio"/>		318.00	
TABLE,REMOVABLE ANGLE ADJ RIGHT, WIDTH 430MM	108507-99-0		<input type="radio"/>	318.00	
TABLE,REMOVABLE ANGLE ADJ LEFT, WIDTH 480MM	108513-99-0	<input type="radio"/>		318.00	
TABLE,REMOVABLE ANGLE ADJ RIGHT, WIDTH 480MM	108508-99-0		<input type="radio"/>	318.00	
TABLE,ANGLE ADJUST. 1-SIDE FIXATION	106863-99-0	<input type="radio"/>	<input type="radio"/>	371.00	
OPTION NOT REQUIRED		<input checked="" type="checkbox"/>			
BRACKET ADDITIONAL POSITION TABLE	107295-99-0	<input type="checkbox"/>		0.00	
COLLEGE TABLE,LEFT	105686-99-0	<input type="radio"/>		233.00	
COLLEGE TABLE RIGHT	105831-99-0		<input type="radio"/>	233.00	
OPTION NOT REQUIRED		<input checked="" type="checkbox"/>			
Pouches/Bags					
ARMREST POUCH,RIGHT BLACK	107339-99-0		<input type="checkbox"/>	39.00	
ARMREST POUCH,LEFT BLACK	107338-99-0	<input type="checkbox"/>		39.00	
SEATFRAME POUCH BLACK	107340-99-0		<input type="checkbox"/>	39.00	
BACK PACK	102059-99-0		<input type="checkbox"/>	159.00	
BACKPACK HOOKS,SET UNITRACK	105563-99-0	<input type="radio"/>		30.00	
BACKPACK HOOK BACKREST PROFILE HIGH	109186-99-0	<input type="radio"/>		30.00	
BACKPACK HOOK BACKREST PROFILE LOW	109187-99-0	<input type="radio"/>		30.00	
OPTION NOT REQUIRED		<input checked="" type="checkbox"/>			
POSITION LEFT BACKPACK HOOK ONLY	109189-99-0	<input type="radio"/>		0.00	
POSITION RIGHT BACKPACK HOOK ONLY	109188-99-0		<input type="radio"/>	0.00	
Other					
SUPPORT HANDLE ARMREST	106058-99-0	<input type="radio"/>	<input type="radio"/>	117.00	
OPTION NOT REQUIRED		<input checked="" type="checkbox"/>			
TRANSFER HANDLES, SET	105260-99-0	<input type="checkbox"/>		186.00	
PUSH HANDLES	105292-99-0	<input type="radio"/>		172.00	
PUSH HANDLES (BACKREST 360)	105795-99-0	<input type="radio"/>		172.00	
OPTION NOT REQUIRED		<input checked="" type="checkbox"/>			
CRUTCH HOLDER	105223-99-0	<input type="radio"/>	<input type="radio"/>	180.00	
OPTION NOT REQUIRED		<input checked="" type="checkbox"/>			
HOLDER OXYGEN BOTTLE C3G	105224-99-0	<input type="checkbox"/>		207.00	
CUP HOLDER	106210-99-0	<input type="checkbox"/>		27.00	
PHONE HOLDER X-GRIP	106806-99-0	<input type="checkbox"/>		76.00	
TABLET HOLDER X-GRIP	106972-99-0	<input type="checkbox"/>		131.00	

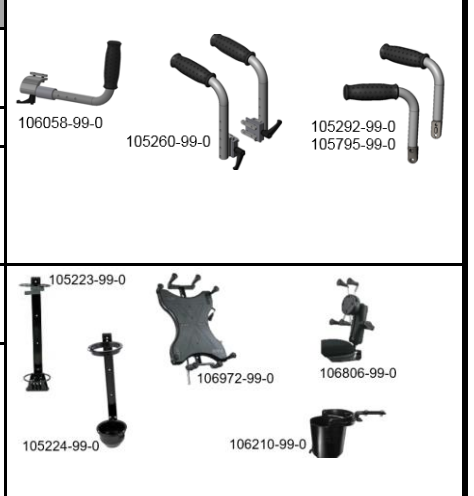
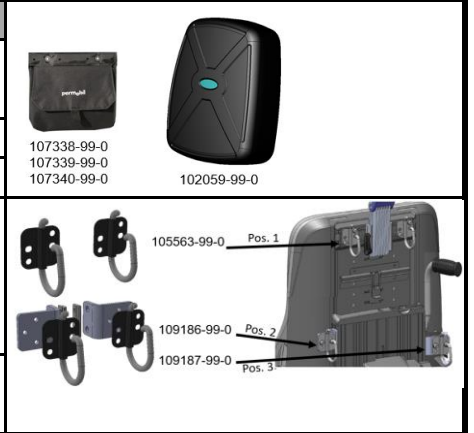
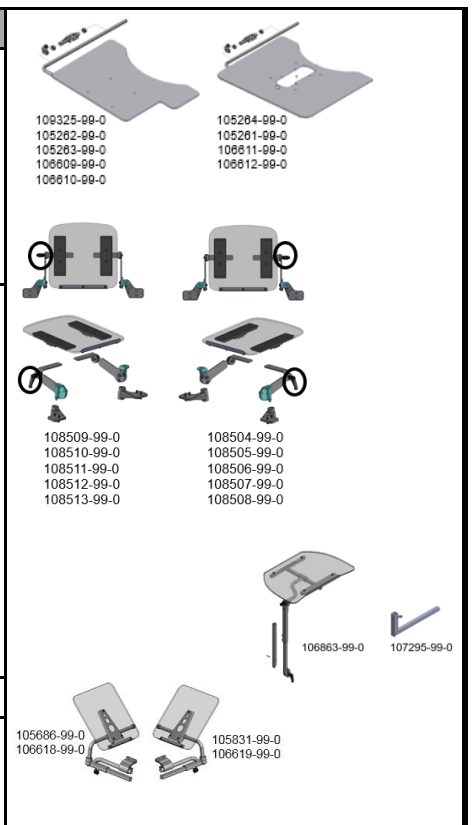

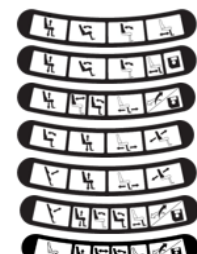
Controls					
User control					
JOYSTICK R-NET WITH 3.5" COLOR DISPLAY	107159-99-0	<input checked="" type="radio"/>		509.00	
JOYSTICK R-NET WITH 3.5" COLOR DISPLAY WITH BT	107779-99-0	<input type="radio"/>		678.00	
JOYSTICK R-NET "EL" LED	105246-99-0	<input type="radio"/>		0.00	
JOYSTICK R-NET HEAVY DUTY WITH COLOUR DISPLAY	105700-99-0	<input type="radio"/>		1039.00	
MDT/RNET: JS COMPACT ADVANCED	103814-99-0	<input type="radio"/>		901.00	
TABLE STEERING, FLIP-OVER 450MM, BACK W. 350	109323-99-0	<input type="radio"/>	<input type="radio"/>	2067.00	
TABLE STEERING, FLIP-OVER 500MM, BACK W. 350/400	109324-99-0	<input type="radio"/>	<input type="radio"/>	2067.00	
TABLE STEERING, FLIP-OVER 600MM, BACK W. 400/450	105293-99-0	<input type="radio"/>	<input type="radio"/>	2067.00	
TABLE STEERING, FLIP-OVER 650MM, BACK W. 450	105294-99-0	<input type="radio"/>	<input type="radio"/>	2067.00	
NON STANDARD STEERING (SEE SPECIAL CONTROLS)	101352-99-0	<input type="radio"/>		0.00	
Parameters Joystick menu					
PROGR.SET: R-NET ASSIGNABLE BUTTONS ENABLE	108858-99-0	<input type="checkbox"/>		0.00	
PROGR.SET: MEM RECALL VIA JS SEAT MENU OFF	104907-99-0	<input type="checkbox"/>		0.00	
PROGR.SET: MEM SAVE VIA JS SEAT MENU OFF	104927-99-0	<input type="checkbox"/>		0.00	
PROGR.SET: SEAT FUNCTIONS VIA JS SEAT MENU OFF	104917-99-0	<input type="checkbox"/>		0.00	
Joystick holder					
PANELHOLDER PARALLEL MOTION UNITRACK	107754-99-0	<input type="radio"/>	<input checked="" type="radio"/>	180.00	
PANELHOLDER SWING AWAY L=335MM	103473-99-0	<input type="radio"/>	<input type="radio"/>	0.00	
PANELHOLDER SWING AWAY L=435MM	103474-99-0	<input type="radio"/>	<input type="radio"/>	0.00	
BODYPOINT MIDLINE MOUNT ASSEMBLY KIT R-NET	108019-99-0	<input type="radio"/>	<input type="radio"/>	541.00	
BODYPOINT MIDLINE MOUNT ASSEMBLY KIT CJS	108020-99-0	<input type="radio"/>	<input type="radio"/>	541.00	
PANEL HOLDER ATTENDANT LONG	107788-99-0	<input type="radio"/>	<input type="radio"/>	244.00	
WITHOUT PANELHOLDER	102835-99-0	<input type="radio"/>		0.00	
Height adjustable holder					
HEIGHT ADJUSTABLE RIGHT JOYSTICK HOLDER	107960-99-0	<input type="radio"/>		133.00	
HEIGHT ADJUSTABLE LEFT JOYSTICK HOLDER	107963-99-0	<input type="radio"/>		133.00	
HEIGHT ADJUSTABLE JOYSTICK HOLDER	108005-99-0	<input type="radio"/>		133.00	
OPTION NOT REQUIRED		<input checked="" type="radio"/>			
Switch box (only for ≥ 20° anterior tilt)					
SWITCH BOX WITH TOGGLE SWITCHES	102799-99-0	<input type="radio"/>		625.00	
SWITCH BOX WITH PUSH BUTTONS	102798-99-0	<input checked="" type="radio"/>		625.00	
WITHOUT SWITCH BOX	104621-99-0	<input type="radio"/>		0.00	
Bracket switch box					
BRACKET SWITCH BOX JOYSTICK	103469-99-0	<input checked="" type="radio"/>		0.00	
BRACKET SWITCH BOX UNITRACK ARMREST	104651-99-0	<input type="radio"/>	<input type="radio"/>	42.00	
BRACKET SWITCH BOX BACKREST	106256-99-0	<input type="radio"/>	<input type="radio"/>	42.00	
SWITCH BOX NOT MOUNTED	105409-99-0	<input type="radio"/>		0.00	
Layout switch box					
SWITCHBOX(1) LAYOUT "A": SINGLE LAYER (STD)	103744-99-0	<input checked="" type="radio"/>		0.00	
SWITCHBOX(1) LAYOUT "B": SINGLE LAYER, MEM	103786-99-0	<input type="radio"/>		0.00	
SWITCHBOX(1) LAYOUT "C": SWAP LAYERS, MEM	103787-99-0	<input type="radio"/>		0.00	
SWITCHBOX(1) LAYOUT "D": SINGLE LAYER (ALT SEQ)	103745-99-0	<input type="radio"/>		0.00	
SWITCHBOX(1) LAYOUT "E": SINGLE LAYER, NO TILT	103788-99-0	<input type="radio"/>		0.00	
SWITCHBOX(1) LAYOUT "F": SINGLE STAND, SWAP, MEM	103789-99-0	<input type="radio"/>		0.00	
					 (A) 103744-99-0 (B) 103786-99-0 (C) 103787-99-0 (D) 103745-99-0 (E) 103788-99-0 (F) 103789-99-0 (L) 105832-99-0

SWITCHBOX(1) LAYOUT "L": SWAP, MEM, 5 OPTIONS

105832-99-0

○	0.00
---	------



Indication level switch box				
SWITCHBOX(1) IND. LEVEL 1: NONE	103746-99-0	<input type="radio"/>		0.00
SWITCHBOX(1) IND. LEVEL 2: SEAT FUNCTION	103747-99-0	<input type="radio"/>		0.00
SWITCHBOX(1) IND. LEVEL 3: SPEED LIMITATION	103748-99-0	<input type="radio"/>		0.00
SWITCHBOX(1) IND. LEVEL 4: COMPLETE	103749-99-0	<input checked="" type="radio"/>		0.00
External charging socket (required with table- or special control)				
EXTRA CHARGER CONNECTOR MOUNTED ON THE ARMREST	104163-99-0	<input type="radio"/>	<input type="radio"/>	117.00
EXTRA CHARGER CONNECTOR MOUNTED ON ACC. RAIL	104164-99-0	<input type="radio"/>	<input type="radio"/>	117.00
EXTRA CHARGER CONNECTOR MOUNTED UNDER SEAT FRA	104165-99-0	<input type="radio"/>	<input type="radio"/>	117.00
OPTION NOT REQUIRED		<input checked="" type="radio"/>		
Lock Key				
LOCKING KEY R-NET	104620-99-0	<input type="checkbox"/>		35.00
Alternative Joystick knobs				
JOYSTICK KNOB CHIN CUP	100960-99-0	<input type="radio"/>		37.00
JOYSTICK KNOB T-GRIP	100961-99-0	<input type="radio"/>		37.00
JOYSTICK KNOB BALL BIG	100962-99-0	<input type="radio"/>		37.00
JOYSTICK KNOB SOFT BALL	100963-99-0	<input type="radio"/>		37.00
JOYSTICK KNOB MUSHROOM	100964-99-0	<input type="radio"/>		37.00
JOYSTICK KNOB STICK	100965-99-0	<input type="radio"/>		37.00
JOYSTICK KNOB BALL SMALL	101165-99-0	<input type="radio"/>		37.00
JOYSTICK KNOB STANDARD	101166-99-0	<input type="radio"/>		37.00
JOYSTICK KNOB SOFT BALL BLACK (CONE)	105442-99-0	<input type="radio"/>		37.00
JOYSTICK KNOB BODYPOINT 7.5CM U-SHAPED	105846-99-0	<input type="radio"/>		59.00
JOYSTICK KNOB BODYPOINT 10CM U-SHAPED	105847-99-0	<input type="radio"/>		59.00
JOYSTICK KNOB BODYPOINT RUBBER DOME	105848-99-0	<input type="radio"/>		54.00
OPTION NOT REQUIRED		<input checked="" type="radio"/>		
Attendant control				
JOYSTICK ATTENDANT RNET WITH 3.5" COLOR DISPLAY	107318-99-0	<input type="radio"/>	<input type="radio"/>	0.00
ATTENDANT CONTROL JOYSTICK LIGHT LED	107320-99-0	<input type="radio"/>	<input type="radio"/>	519.00
JOYSTICK ATTENDANT RNET SPEED/MODE	107321-99-0	<input type="radio"/>	<input type="radio"/>	519.00
SCOOT CONTROL R-NET	109532-99-0	<input type="radio"/>		2433.00
OPTION NOT REQUIRED		<input checked="" type="radio"/>		
Emergency switch				
EMERGENCY STOP SWITCH	101792-99-0	<input type="checkbox"/>		207.00



Supplementary accessoires

(Mounting costs can apply)

MDT/RNET: JS COMPACT (LOW FORCE)	103892-99-0	<input type="radio"/>	1431.00						103817-99-0	103892-99-0	105289-99-0			
MDT/RNET: JS COMPACT	103817-99-0	<input type="radio"/>	901.00											
MDT/RNET: MINI JOYSTICK	105289-99-0	<input type="radio"/>	2173.00											
MICRO JOYSTICK R-NET, W. 300MM RNET CABLE	109524-99-0	<input type="radio"/>	2173.00											
MULTI JOYSTICK R-NET, W. 300MM RNET CABLE	109526-99-0	<input type="radio"/>	1961.00											
ALL-ROUND JOYSTICK LIGHT RNET W. 300MM RNET CABLE	109528-99-0	<input type="radio"/>	1643.00											
ALL-ROUND JOYSTICK R-NET, W. 300MM RNET CABLE	109530-99-0	<input type="radio"/>	1049.00											
OPTION NOT REQUIRED		<input type="checkbox"/>												
PANEL HOLDER ATTENDANT	105210-99-0	<input type="checkbox"/>	244.00											
CHEST SUPPORT FOR TABLE CII/VII VINYL	101303-99-0	<input type="checkbox"/>	181.00											
CHARGER USB	107189-99-0	<input type="radio"/>	143.00											
OPTION NOT REQUIRED		<input type="checkbox"/>												
SWITCH KIT FOR COMPACT JS (CHIN)	104641-99-0	<input type="checkbox"/>	339.00											
BUDDY BUTTON BLACK 63 MM	101766-99-0	0	▼	103.00										
BUDDY BUTTON RED 63 MM	101767-99-0	0	▼	103.00										
BUDDY BUTTON YELLOW 63 MM	101768-99-0	0	▼	103.00										
MICRO LIGHT SWITCH	101769-99-0	0	▼	162.00										
CUP SWITCH 45 MM	101770-99-0	0	▼	162.00										
MINI CUP SWITCH 24 MM	101771-99-0	0	▼	139.00										
GRASP SWITCH	101772-99-0	0	▼	235.00										
SATELLITE TWISTER, BLACK CABLE 30CM	109546-99-0	0	▼	189.00										
SATELLITE TWISTER, RED CABLE 30CM	109547-99-0	0	▼	189.00										
SATELLITE TWISTER, YELLOW CABLE 30CM	109548-99-0	0	▼	189.00										
SATELLITE TWISTER, BLUE CABLE 30CM	109549-99-0	0	▼	189.00										
SATELLITE TWISTER, GREEN CABLE 30CM	109550-99-0	0	▼	189.00										
CONNECTION BOX EXTERNAL SWITCHES SEATING	104196-99-0	<input type="checkbox"/>	625.00											
CONNECTION BOX EXTERNAL SWITCHES R-NET (RBI)	104696-99-0	<input type="checkbox"/>	661.00											
HAND WARMER SET	109533-99-0	<input type="checkbox"/>	636.00											
CONE 1 HAND HAND HEATER	107363-99-0	<input type="radio"/>	170.00											
CONE 2 HANDS HAND HEATER	107364-99-0	<input type="radio"/>	260.00											
OPTION NOT REQUIRED		<input type="checkbox"/>												

User consent for the installation of ConnectMe

Please select one of the below options:

- I consent to the installation of the ConnectMe hardware at the time of manufacture. I understand this to mean that the ConnectMe hardware will be installed and ready to activate at the time of my receipt of the wheelchair and, once activated, will include the ability to monitor how my wheelchair is functioning while active, including the use of location data. I may withdraw my consent at any time by contacting my provider or Permobil directly.
- I give my consent to Permobil to contact me regarding the activation of my wheelchair for the purpose of providing support with the activation process.

Name: _____

Email: _____

Phone (optional):

Signature:

Notes