



permobil Order Form - Progeo DUKE

Permobil Limited Unit 7, Polaris Centre, 41 Brownfields, Welwyn Garden City, Herts, AL7 1AN United Kingdom - Phone: +44 1484 722888

Date	UK (English)	
User	Company stamp	Rigid frame wheelchair
End user weight (kg)		£ 4236,00
Language user manual	Responsible	Retail price - VAT not included

Wheelchair measures	
Seat width (LS) <input type="checkbox"/> 33 <input type="checkbox"/> 36 <input type="checkbox"/> 39 <input type="checkbox"/> 42 <input type="checkbox"/> 45 <input type="checkbox"/> 48	The seat width is measured from the outer sides of the frame, while the distance between the two side guards is 1.5 cm wider.
Seat depth (PS) <input type="checkbox"/> 35 <input type="checkbox"/> 37,5 <input type="checkbox"/> 40 <input type="checkbox"/> 42,5 <input type="checkbox"/> 45 <input type="checkbox"/> 47,5 <input type="checkbox"/> 50	The real seat depth, from the front part of the seat cloth to the backrest tube will be 1,5 cm more than the declared one.
Footplate distance (DP)	(cm) ±0.5cm - adjustment steps 1.5cm
(Real distance between seat and footplate) - IMPORTANT NOTICE! From the footplate to the floor minimum 4cm !! (Minimum Front height = DP + 4cm.)	
Setting	<input checked="" type="checkbox"/> Standard <input type="checkbox"/> Prudential <input type="checkbox"/> Active
Backrest Height (TS)	Std.Value 33,5(min 24.5-max 47) adjustment steps 1.5cm
Camber	<input checked="" type="checkbox"/> 0° <input type="checkbox"/> 2° <input type="checkbox"/> 4°

<p>Front frame</p> <p>☆ Carbon fibre frame, Angle 90° to the seat</p>	
--	---

<p>Front height - Tick the box with the required height</p> <p>The possible difference in height between HIGH frame and LOW frame is 3cm (with same fork, caster and assembly hole).</p>		
	 SPORT fork (H95)	 Small size fork (H115)
<p>LOW FRAME 90°</p> <p>Front height (min 44,5 - max 50)</p> <p>Footplate distance (min 34,5)</p> <div style="border: 1px solid red; padding: 2px; margin-top: 5px;"> <p style="color: red; font-size: small;">U-TUBE Aluminium footplate Footplate distance (min 18 + max 35) DPmax = Front height - 10cm</p> </div>	<p style="text-align: center;">Casters</p> <p>3" <input type="checkbox"/> ~45 <input type="checkbox"/> ~46</p> <p>4" <input type="checkbox"/> ~46 <input type="checkbox"/> ~47</p> <p>5" <input type="checkbox"/> ~48,5</p>	<p style="text-align: center;">Casters</p> <p>3" <input type="checkbox"/> ~45,5 <input type="checkbox"/> ~47</p> <p>4" <input type="checkbox"/> ~46,5 <input type="checkbox"/> ~48 <input type="checkbox"/> ~49</p> <p>5" <input type="checkbox"/> ~49 <input type="checkbox"/> ~50</p>
<p>HIGH FRAME 90°</p> <p>Front height (min 47,5 - max 53)</p> <p>Footplate distance (min 37,5)</p> <div style="border: 1px solid red; padding: 2px; margin-top: 5px;"> <p style="color: red; font-size: small;">U-TUBE Aluminium footplate Footplate distance (min 21 + max 38) DPmax = Front height - 10cm</p> </div>	<p style="text-align: center;">Casters</p> <p>3" <input type="checkbox"/> ~48 <input type="checkbox"/> ~49</p> <p>4" <input type="checkbox"/> ~49 <input type="checkbox"/> ~50</p> <p>5" <input type="checkbox"/> ~51,5</p>	<p style="text-align: center;">Casters</p> <p>3" <input type="checkbox"/> ~48,5 <input type="checkbox"/> ~50</p> <p>4" <input type="checkbox"/> ~49,5 <input type="checkbox"/> ~51 <input type="checkbox"/> ~52</p> <p>5" <input type="checkbox"/> ~52 <input type="checkbox"/> ~53</p>
<p>The real front-seat height could be slightly different from the chosen one considering it is affected by seat depth and rear seat height.</p>		
<p>Rear height The difference between Font Height and Rear Height must be in the 3 - 12 cm range.</p> <p>Rear wheels 22" (min 36 - max 44)</p> <p>Rear wheels 24" (min 38 - max 46)</p> <p>Rear wheels 25" (min 39 - max 47)</p> <p>Rear wheels 26" (min 41 - max 48)</p>		

Seat	
☆ Seat cloth with pocket (under seat)	
<input type="radio"/> Seat with tension straps	08883 224,00
<input type="radio"/> Carbon rigid seat	08336 475,00
<input type="radio"/> Pocket (under seat) [25x11x4,5]	08281 74,00

Date Order User Address

CUSTOMIZE COLORS

- ① Fork colour**
 ☆ Opaque black
- | | |
|---|--------------------------------------|
| <input type="radio"/> Bright silver | <input type="radio"/> Bright orange |
| <input type="radio"/> Bright anthracite | <input type="radio"/> Bright blue |
| <input type="radio"/> Pearl white | <input type="radio"/> Bright fuchsia |
| <input type="radio"/> Bright red | <input type="radio"/> Bright lime |
- 08342 63,00

- ② Colour rear wheels**
 To be matched only with: Rear wheels Ultra-light Progeo - Standard! (22 - 24)
 ☆ Black
- | | |
|---|--------------------------------------|
| <input type="radio"/> Bright silver | <input type="radio"/> Bright orange |
| <input type="radio"/> Bright anthracite | <input type="radio"/> Bright blue |
| <input type="radio"/> Pearl white | <input type="radio"/> Bright fuchsia |
| <input type="radio"/> Bright red | <input type="radio"/> Bright lime |
- 04692 63,00

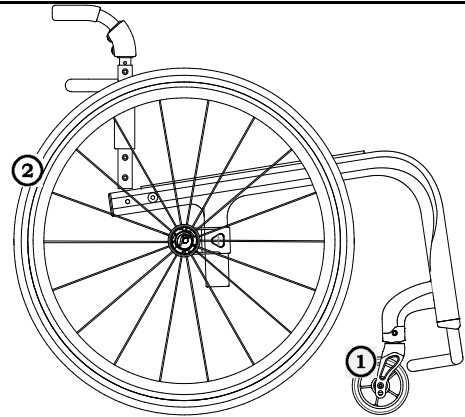

Rear wheels axle



- ☆ Aluminum rear wheels axle
- Carbon fiber rear wheels axle (Lightest configuration) 07647 148,00

Backrest adjustment and fixing system





- ☆ Backrest with double locking (upright and folded) with rake adjustable from -4° to +16°
 Backrest with upright locking system ONLY (no locking when folded) with rake adjustable from -4° to +16°
 Fixed back(non-folding back) with rake adjustable from -4° to +16°

Backrest

- ☆ Adjustable velcro straps and padded transpiring upholstery

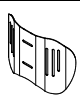

- | | | | |
|---|---|-------|--------|
| ☆ Aluminium backrest |  | | |
| <input type="radio"/> Titanium backrest |  | 06811 | 189,00 |
| <input type="radio"/> Carbon fibre backrest |  | 04389 | 749,00 |

- AIR** Integrated posture backrest (NOT REMOVABLE) 1.047,00
 Carbon shell - Lateral retaining 7,5cm
 Depth adjustment ±1cm. - Angle adjustment ±10°
 not available for seat width 48

H 28		H 34		H 40	
Backrest Height (TS) min 34		Backrest Height (TS) min 38		Backrest Height (TS) min 44	
(.....)		(.....)		(.....)	
Lateral retaining wing A=high - R=regular					
A	R	A	R	A	R
					
<input type="checkbox"/>	<input type="checkbox"/>	<input type="checkbox"/>	<input type="checkbox"/>	<input type="checkbox"/>	<input type="checkbox"/>

Installation on:

☆ Backrest tubes



- | | | | |
|---|---|-------|--------|
| <input type="checkbox"/> Aluminium backrest |  | | |
| <input type="radio"/> Titanium backrest |  | 06811 | 189,00 |
| <input type="radio"/> Carbon fibre backrest |  | 04389 | 749,00 |

Handle tube

- ☆ Tubes with standard handle
- Tubes with short handle
- SPORT tubes Without push handles
- Carbon fibre tubes with short handle Weight reduction approx. 110gr. 04390 148,00
Not available with: Posture backrest PHYSIO - Posture backrest A I R
- Folding handles  02958 252,00

Date Order User Address

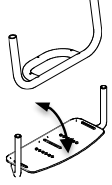
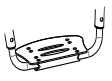
Footplate

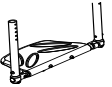
☆ Aluminium footplate. Rake not adjustable			
☆ Aluminium footplate	<input type="checkbox"/> with plastic plate		
○ One piece aluminium footplate - Flip-up! FLIP-BACK! - rake and depth adjustable			09420 189,00
○ Aluminium footplate, rake and depth adjustable			04456 252,00
☆ Internal	<input type="checkbox"/> 2/3 Internal	<input type="checkbox"/> External	<input type="checkbox"/> 2/3 External
○ U-TUBE - Aluminium footplate, rake and depth adjustable			09853 224,00
LOW FRAME: minimum footplate distance 18 - maximum footplate distance 35			
HIGH FRAME: minimum footplate distance 21 - maximum footplate distance 38			
○ One piece Carbon fibre footplate. Rake adjustable			04110 372,00
☆ Internal	<input type="checkbox"/> External		

Mudguard

☆ Carbon fibre mudguard			
<input type="checkbox"/> Carbon fibre Straight sideguard			
○ Removable version			08921 126,00

Casters

☆ 4" Soft			
<input type="checkbox"/> 3" Sport			
<input type="checkbox"/> 5" Soft			
○ 3" Active Soft (wide)	(Aluminium alloy rim)		06824 126,00
○ 4" Active Sport (narrow)	(Aluminium alloy rim)		01398 126,00
○ 4" Active Soft (wide)	(Aluminium alloy rim)		03943 126,00
○ 5" Active Soft (wide)	(Aluminium alloy rim)		07518 126,00
○ 5" Pneumatic			10844 63,00

Rear wheels



☆ 24" Ultra-light Progeo - Standard!			
<input type="checkbox"/> 22" Ultra-light Progeo - Standard!			
<input type="checkbox"/> 25" Ultra-light Progeo - Standard!	(colour: black)		
<input type="checkbox"/> 26" Progeo - Standard!	(colour: black)		
○ 24" ULTRA-LIGHT PROGEO KEY SPORT	Weight reduction approx. 450gr.		04383 876,00
○ 24" Ultra-light "Spinergy LX"			01685 876,00
○ 24" Ultra-light "Spinergy LXL"	<input type="checkbox"/> Black hub and white spokes	<input type="checkbox"/> Hub and spokes black	07846 876,00
○ 24" Ultra-light "Spinergy Flex rim"	Integrated aluminium/rubber handrim		02270 1.374,00
○ 25" Ultra-light "Spinergy LX"			02101 876,00
○ 25" Ultra-light "Spinergy LXL"	<input type="checkbox"/> Black hub and white spokes		07847 876,00
○ 26" Ultra-light "Spinergy LX"			02102 876,00
○ 24" Off-road (aluminium handrim black)			01392 224,00



Rear wheel tyre

☆ High pressure tyre	(22"-24"-25"-26")		
<input type="checkbox"/> High pressure profile tyre	(24")		
○ Marathon Plus	(24"-25")	with anti-puncture protection	01669 63,00
○ Anti-puncture - Colour Grey	(22")		04181 98,00
○ Anti-puncture - Colour Black	(24")		11083 126,00



Date Order User Address



Handrim	Wheel distance	☆ 3 cm	□ 4 cm		
☆ Aluminium	(22"-24"-25"-26")				
○ Aluminium black SOFT-TOUCH	(24"-25")		(24" handrim, on 25" wheel is installed with spacers)	09170	126,00
○ Chromed Steel	(24"-25")		(24" handrim, on 25" wheel is installed with spacers)	01684	148,00
○ Titanium	(24"-25")		(24" handrim, on 25" wheel is installed with spacers)	00016	275,00
○ Ultra Grepp	(24"-25")		(24" handrim, on 25" wheel is installed with spacers)	00017	315,00
○ Max Grepp	(24"-25")		(24" handrim, on 25" wheel is installed with spacers)	00834	349,00
○ Ergo Para	(24")			00632	349,00
○ TOP FRICTION	(24"-25")		(24" handrim, on 25" wheel is installed with spacers)	11023	399,00
Oval countour with a rubber insert					
○ NOVA H	(24"-25")		(24" handrim, on 25" wheel is installed with spacers)	11025	263,00
Ergonomic black profile					
○ NOVA D	(24"-25")		(24" handrim, on 25" wheel is installed with spacers)	11026	286,00
Ergonomic profile with rubber coating (ideal for quadriplegics)					
○ SURGE LT	(25")		Oval countour with a rubber insert	06427	360,00
○ Quad (24")	(24")			00693	200,00
○ Silicon cover for standard aluminium handrim			Available for measures (22" - 24" - 26")	04050	160,00

Wheel locks			
☆ Bent lever push to lock			
□ Straight lever push to lock			
□ Straight lever pull to lock			
○ Sport brake			06428 126,00
○ Brake with extension lever push to lock			01949 63,00
○ Brake with extension lever pull to lock			03372 63,00

Armrests			
Tubular armrests	(Swing away, removable and height adjustable armrest)		00694 252,00
○ Removable armrest with carbon-fiber straight sideguard			09079 224,00

Accessories			
○ Pad for front frame protectors			07058 52,00
○ Backrest-seat connection cloth			10241 17,00
○ Removable storage bag (with quick coupling)			09811 126,00

Optional 1			
Only one optional devices for side can be chosen			
○ Transit wheels	Exclude the installation of Anti-tippers		03290 148,00
○ Anti-tipper with rapid hookup	Exclude the installation of Transit wheels (inside rotation to reduce the encumbrance)		06821 126,00
	○ Right		06822 126,00
	○ Left		

Optional 2			
○ Push handles for companion	(Removable and height adjustable)		03645 177,00
○ Tetraclip	(Quick release axle for quadriplegic)		03947 177,00
○ Safety pelvic belt			03972 63,00
○ Harness			04103 126,00
○ Lumbar support	(to insert in the backrest upholstery)		00013 40,00
○ Swing away lateral support	○ Right		02097 252,00
Not available with:	○ Left		02098 252,00
Posture backrest PHYSIO - Posture backrest A I R			
○ Spoke guards Black	(22"-24")		01043 148,00
○ Spoke guards Transparent	(22"-24")		00835 148,00
○ Spoke guards Progeo design	(22"-24")		00019 177,00
○ Spoke guards Dragon	(22"-24")		02106 177,00

Additional Kit			
○ 24" Off-road rear wheels	Off-Road tyre - aluminium handrim (black colour)		03378 498,00
○ 24" FAT rear wheels	FAT tyre 3" - aluminium handrim (black colour)		09357 876,00

Date Order User Address

PHYSIO - Posture backrest (Std. Backrest upholstery not provided)

Removable with quick release
Suitable for tubes with diameter 18±26mm
Depth adjustment (4cm)
Angle adjustment (±18°)

- AIR** Carbon shell
not available for seat width 48

BACKREST HEIGHT	28	34	40			
Shell's shape  7,5 cm	Lateral retaining wing A=high - R=regular					
	A	R	A	R	A	R
	<input type="checkbox"/>	<input type="checkbox"/>	<input type="checkbox"/>	<input type="checkbox"/>	<input type="checkbox"/>	<input type="checkbox"/>

1.047,00

- POSTURE** Aluminum shell

BACKREST HEIGHT	34	40	52
Shell's shape  7,5 cm	Lateral retaining wing B=regular		
	R	R	R
	<input type="checkbox"/>	<input type="checkbox"/>	<input type="checkbox"/>

1.013,00

Configuration DEEP with side support PAD (height adjustable)

- Alluminum lateral with padded, breathable upholstery.



Small (h 13cm)



Right
10272

29,00



Left
10272

29,00

Large (h 20cm)



Right
10273

40,00



Left
10273

40,00

SWING AWAY - Lateral support

Fixing and adjustment hardware complete with protection sleeve
Alluminum lateral with padded, breathable upholstery.

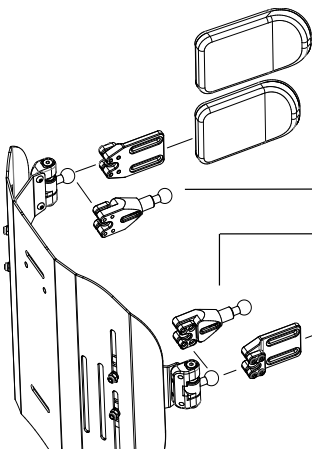

- Large (18x12)

05647 183,00

- Small (14x9)

05643 183,00

- Lateral support extension

Quantity (number pcs)..... 10271 69,00

- Lateral support extension

Quantity (number pcs).....

- Small (14x9)

05642 183,00

- Large (18x12)

05646 183,00

- Headrest adjustable - Double ball mounting system

Available only with backrest Physio
Not available for backrest Physio AIR carbon shell



- Large (34x14)
 Small (28x14)

05648 252,00

Date Order User Address

Permobil Limited Unit 7, Polaris Centre, 41 Brownfields, Welwyn Garden City, Herts, AL7 1AN United Kingdom - Phone: +44 1484 722888

customer_support_uk@permobil.com - https://www.permobil.com/en-gb

Note

Wheelchair : Progeo DUKE - Rev. 2023.2

Prices - VAT excluded
to be added to the price list

Send this page only if any optional have been chosen

- standard (supplied if no requests are indicated)
- on request (without extra charge)
- optional (cost to be added at the basic price)