

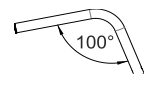
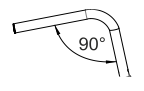
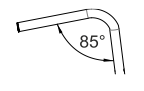

Date	UK (English)	
User	Company stamp	Folding frame wheelchair
End user weight (kg)		£ 4064,00
Language user manual	Responsible	Retail price - VAT not included

Wheelchair measures						
Seat width (LS)	<input type="checkbox"/> 33	<input type="checkbox"/> 36	<input type="checkbox"/> 39	<input type="checkbox"/> 42	<input type="checkbox"/> 45	<input type="checkbox"/> 48
<small>The seat width is measured from the outer sides of the frame, while the distance between the two side guards is 1 cm wider.</small>						
Seat depth (PS)	<input type="checkbox"/> 35	<input type="checkbox"/> 37,5	<input type="checkbox"/> 40	<input type="checkbox"/> 42,5	<input type="checkbox"/> 45	<input type="checkbox"/> 47,5
<small>The real seat depth, from the front part of the seat cloth to the backrest tube will be 1,5 cm more than the declared one.</small>						
Footplate distance (DP) (cm) ±0.5cm - adjustment steps 1.5cm					
<small>(Real distance between seat and footplate) - IMPORTANT NOTICE! From the footplate to the floor minimum 4cm !! (Minimum Front height = DP + 4cm.)</small>						
Setting	☆ Standard		<input type="checkbox"/> Prudential	<input type="checkbox"/> Active		
Backrest Height (TS)	Std.Value 33,5(min 24.5-max 47) adjustment steps 1.5cm					
camber	☆ 0°		<input type="checkbox"/> 2°			
Front height STD 49					
Rear height STD 42					

Front frame	
☆ Aluminium standard frame	
<p style="writing-mode: vertical-rl; transform: rotate(180deg);">Aluminium frame</p> <div style="display: flex; justify-content: space-around; align-items: center;"> <div style="text-align: center;">  <p>☆</p> </div> <div style="text-align: center;">  <p><input type="checkbox"/></p> <p>(max 5" caster)</p> </div> <div style="text-align: center;">  <p><input type="checkbox"/></p> <p>(max 4" caster)</p> </div> </div>	<p>Colour aluminium frame</p> <p>☆ Bright silver</p> <ul style="list-style-type: none"> <input type="checkbox"/> Polished black <input type="checkbox"/> Opaque black <input type="checkbox"/> Bright blue <input type="checkbox"/> Bright anthracite <input type="checkbox"/> Bright orange <input type="checkbox"/> Bright fuchsia <input type="checkbox"/> Bright red <input type="checkbox"/> Bright lime <input type="checkbox"/> Bright blue china <input type="checkbox"/> Pearl white

<p>Backrest</p> <p>☆ Adjustable velcro straps and padded transpiring upholstery</p>
--

<p>Handle tube</p> <p>☆ Tubes with short handle</p> <p><input type="checkbox"/> SPORT tubes Without push handles (Lightest configuration)</p> <p><input type="radio"/> Folding handles</p>	 <p>02958 252,00</p>
---	--

<p>Casters</p> <p>☆ 4" Soft</p> <p><input type="checkbox"/> 3" Sport (Lightest configuration)</p> <p><input type="checkbox"/> 5" Soft</p> <p><input type="checkbox"/> 6" Soft (Available only with 100° angle)</p> <p><input type="checkbox"/> 6" Pneumatic (Available only with 100° angle)</p>	<table style="width: 100%; border-collapse: collapse;"> <tr> <td><input type="radio"/> 3" Active Soft (wide)</td> <td>(Aluminium alloy rim)</td> <td style="text-align: right;">06824</td> <td style="text-align: right;">126,00</td> </tr> <tr> <td><input type="radio"/> 4" Active Sport (narrow)</td> <td>(Aluminium alloy rim)</td> <td style="text-align: right;">01398</td> <td style="text-align: right;">126,00</td> </tr> <tr> <td><input type="radio"/> 4" Active Soft (wide)</td> <td>(Aluminium alloy rim)</td> <td style="text-align: right;">03943</td> <td style="text-align: right;">126,00</td> </tr> <tr> <td><input type="radio"/> 5" Active Soft (wide)</td> <td>(Aluminium alloy rim)</td> <td style="text-align: right;">07518</td> <td style="text-align: right;">126,00</td> </tr> <tr> <td><input type="radio"/> 5" Pneumatic</td> <td></td> <td style="text-align: right;">10844</td> <td style="text-align: right;">63,00</td> </tr> </table>	<input type="radio"/> 3" Active Soft (wide)	(Aluminium alloy rim)	06824	126,00	<input type="radio"/> 4" Active Sport (narrow)	(Aluminium alloy rim)	01398	126,00	<input type="radio"/> 4" Active Soft (wide)	(Aluminium alloy rim)	03943	126,00	<input type="radio"/> 5" Active Soft (wide)	(Aluminium alloy rim)	07518	126,00	<input type="radio"/> 5" Pneumatic		10844	63,00
<input type="radio"/> 3" Active Soft (wide)	(Aluminium alloy rim)	06824	126,00																		
<input type="radio"/> 4" Active Sport (narrow)	(Aluminium alloy rim)	01398	126,00																		
<input type="radio"/> 4" Active Soft (wide)	(Aluminium alloy rim)	03943	126,00																		
<input type="radio"/> 5" Active Soft (wide)	(Aluminium alloy rim)	07518	126,00																		
<input type="radio"/> 5" Pneumatic		10844	63,00																		

<p>Support front fork</p> <p>☆ Standard support front fork</p> <p><input type="checkbox"/> Front fork support V Design 2.0 <small>Exclude the installation of : Quick release front forks</small></p>	 
--	--

Date	Order	User	Address
------------	-------------	------------	---------------





Special Options		
<input type="checkbox"/> Rear wheels plate extension	01950	177,00
<input type="checkbox"/> lockingband/strip to close/fold the wheelchair	06833	23,00
<input type="checkbox"/> Drawstring to unlock the back with a single action	06834	126,00

Colour set: Rear wheels and forks - To be matched only with: Rear wheels Ultra-light Progeo - Standard! (22 - 24)		
☆ Black	22" 24" 25" 26"	
<input type="checkbox"/> Bright silver	22" 24"	00833 126,00
<input type="checkbox"/> Bright anthracite	24"	00833 126,00
<input type="checkbox"/> Bright orange	22" 24"	00833 126,00
<input type="checkbox"/> Bright fuchsia	22" 24"	00833 126,00
<input type="checkbox"/> Bright blue	22" 24"	00833 126,00
<input type="checkbox"/> Bright red	22" 24"	00833 126,00
<input type="checkbox"/> Bright lime	22" 24"	00833 126,00
<input type="checkbox"/> Pearl white	22" 24"	00833 126,00

Rear wheels		
☆ 24" Ultra-light Progeo - Standard!		
<input type="checkbox"/> 22" Ultra-light Progeo - Standard!		
<input type="checkbox"/> 25" Ultra-light Progeo - Standard!	(colour: black)	
<input type="checkbox"/> 26" Progeo - Standard!	(colour: black)	
<input type="checkbox"/> 24" ULTRA-LIGHT PROGEO KEY SPORT	(Lightest configuration)	04383 876,00
<input type="checkbox"/> 24" Ultra-light "Spinergy LX"		01685 876,00
<input type="checkbox"/> 24" Ultra-light "Spinergy LXL"	<input type="checkbox"/> Black hub and white spokes <input type="checkbox"/> Hub and spokes black	07846 876,00
<input type="checkbox"/> 24" Ultra-light "Spinergy Flex rim"	Integrated aluminium/rubber handrim	02270 1.374,00
<input type="checkbox"/> 25" Ultra-light "Spinergy LX"		02101 876,00
<input type="checkbox"/> 25" Ultra-light "Spinergy LXL"	<input type="checkbox"/> Black hub and white spokes	07847 876,00
<input type="checkbox"/> 26" Ultra-light "Spinergy LX"		02102 876,00
<input type="checkbox"/> 24" Off-road (aluminium handrim black)		01392 224,00

Rear wheel tyre		
☆ High pressure tyre	(22"-24"-25"-26")	(Lightest configuration)
<input type="checkbox"/> High pressure profile tyre	(24")	
<input type="checkbox"/> Marathon Plus	(24"-25")	with anti-puncture protection
<input type="checkbox"/> Anti-puncture - Colour Black	(24")	01669 63,00
<input type="checkbox"/> Anti-puncture - Colour Grey	(22")	11083 126,00
		04181 98,00

Handrim		
	Wheel distance	☆ 3 cm □ 4 cm
☆ Aluminium	(22"-24"-25"-26")	(Lightest configuration)
<input type="checkbox"/> Aluminium black SOFT-TOUCH	(24"-25")	(24" handrim, on 25" wheel is installed with spacers)
<input type="checkbox"/> Chromed Steel	(24"-25")	(24" handrim, on 25" wheel is installed with spacers)
<input type="checkbox"/> Titanium	(24"-25")	(24" handrim, on 25" wheel is installed with spacers)
<input type="checkbox"/> Ultra Grepp	(24"-25")	(24" handrim, on 25" wheel is installed with spacers)
<input type="checkbox"/> Max Grepp	(24"-25")	(24" handrim, on 25" wheel is installed with spacers)
<input type="checkbox"/> Ergo Para	(24")	
<input type="checkbox"/> TOP FRICTION	(24"-25")	(24" handrim, on 25" wheel is installed with spacers)
Oval countour with a rubber insert		
<input type="checkbox"/> NOVA H	(24"-25")	(24" handrim, on 25" wheel is installed with spacers)
Ergonomic black profile		
<input type="checkbox"/> NOVA D	(24"-25")	(24" handrim, on 25" wheel is installed with spacers)
Ergonomic profile with rubber coating (ideal for quadriplegics)		
<input type="checkbox"/> SURGE LT	(25")	Oval countour with a rubber insert
<input type="checkbox"/> Quad	(24")	
<input type="checkbox"/> Silicon cover for standard aluminium handrim		Available for measures (22" - 24" - 26")
		06427 360,00
		00693 200,00
		04050 160,00

Wheel locks		
☆ Bent lever push to lock		
<input type="checkbox"/> Straight lever push to lock		
<input type="checkbox"/> Straight lever pull to lock		
<input type="checkbox"/> Sport brake	(Lightest configuration)	 06428 126,00

Permobil Limited Unit 7, Polaris Centre, 41 Brownfields, Welwyn Garden City, Herts, AL7 1AN United Kingdom - Phone: +44 1484 722888

customer_support_uk@permobil.com - https://www.permobil.com/en-gb

Date Order User Address

Automatic Closure footplate

☆ Footplate COMPACT, automatic Closure (Lightest configuration)  11529 no list

Minimum footplate distance 35cm. RAKE AND DEPTH ADJUSTABLE

Internal External

Footplate - See reference tables N°3

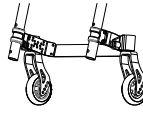
Warning!! All flip-up footrests, need a stretch calf band and standard fork-support 

Weight increase approx. 500gr.

Plastic footrest, rake adjustable Minimum footplate distance 35cm. ☆ 2/3 Internal 2/3 External  11525 no list

One piece footplate - Flip-up!. rake and depth adjustable Minimum footplate distance 35cm. Internal ☆ 2/3 Internal External  11527 no list

One piece aluminium footplate - Flip-up!. rake and depth adjustable Minimum footplate distance 35cm. Internal ☆ 2/3 Internal 2/3 External  11528 no list

One piece Carbon fibre footplate, rake adjustable, swing away, flip-up. Minimum footplate distance 35cm. ☆ Internal External  03291 275,00

Mudguard

Mudguard - FIXED

☆ Carbon fibre mudguard 

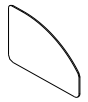
Carbon fibre Straight sideguard 

Extra charge for : REMOVABLE VERSION  08921 126,00

Armrests

Tubular armrests (Swing away, removable and height adjustable armrest)  00694 252,00

Removable armrest with ABS mudguard

Desk armrests PROGEO (Removable and height adjustable)  09956 224,00

Removable armrest with carbon-fiber straight sideguard  09079 224,00





Accessories

Pad for front frame protectors 07058 52,00

Backrest-seat connection cloth 10241 17,00

Removable storage bag (with quick coupling) 09811 126,00

Date	Order	User	Address
------------	-------------	------------	---------------

Optional 1			
<input type="checkbox"/> Transit wheels			00836 148,00
<input type="checkbox"/> Anti-tipper with rapid hookup	(inside rotation to reduce the encumbrance) <input type="radio"/> Right <input type="radio"/> Left		00023 126,00 00024 126,00
<input type="checkbox"/> Tipping aid	<input type="radio"/> Right <input type="radio"/> Left		00025 74,00 01046 74,00
<input type="checkbox"/> Crutches support	<input type="radio"/> Right <input type="radio"/> Left		00838 74,00 00837 74,00

Optional 2			
<input type="checkbox"/> Tetracrip	(Quick release axle for quadriplegic)		03947 177,00
<input type="checkbox"/> Safety pelvic belt			03972 63,00
<input type="checkbox"/> Harness			04103 126,00
<input type="checkbox"/> Quick release front forks	Available with: Standard support front fork		00030 148,00
<input type="checkbox"/> Push handles for companion	(Removable and height adjustable)		01048 189,00
<input type="checkbox"/> Lumbar support	(to insert in the backrest upholstery)		00013 40,00
<input type="checkbox"/> Swing away lateral support	Not available with Posture backrest PHYSIO <input type="radio"/> Right <input type="radio"/> Left		02097 252,00 02098 252,00
<input type="checkbox"/> Spoke guards Black	(22"-24")		01043 148,00
<input type="checkbox"/> Spoke guards Transparent	(22"-24")		00835 148,00
<input type="checkbox"/> Spoke guards Progeo design	(22"-24")		00019 177,00
<input type="checkbox"/> Spoke guards Dragon	(22"-24")		02106 177,00

Additional Kit			
<input type="checkbox"/> 24" Off-road rear wheels	Off-Road tyre - aluminium handrim (black colour)		03378 498,00
<input type="checkbox"/> 24" FAT rear wheels	FAT tyre 3" - aluminium handrim (black colour)		09357 876,00

Date Order User Address

PHYSIO - Posture backrest (Std. Backrest upholstery not provided)

Removable with quick release
Suitable for tubes with diameter 18÷26mm
Depth adjustment (4cm)
Angle adjustment (±18°)

- AIR** Carbon shell
not available for seat width 48

BACKREST HEIGHT	28	34	40			
Shell's shape  7.5 cm	Lateral retaining wing A=high - R=regular					
	A	R	A	R	A	R
	<input type="checkbox"/>	<input type="checkbox"/>	<input type="checkbox"/>	<input type="checkbox"/>	<input type="checkbox"/>	<input type="checkbox"/>

1.047,00

- POSTURE** Aluminum shell

BACKREST HEIGHT	34	40	52	
Shell's shape  7.5 cm	Lateral retaining wing B=regular			
	R	R	R	
	<input type="checkbox"/>	<input type="checkbox"/>	<input type="checkbox"/>	

1.013,00

Configuration DEEP with side support PAD (height adjustable)

- Alluminum lateral with padded, breathable upholstery.



Small (h 13cm)



Right
10272

29,00



Left
10272

29,00

Large (h 20cm)



Right
10273

40,00



Left
10273

40,00

SWING AWAY - Lateral support

Fixing and adjustment hardware complete with protection sleeve
Alluminum lateral with padded, breathable upholstery.

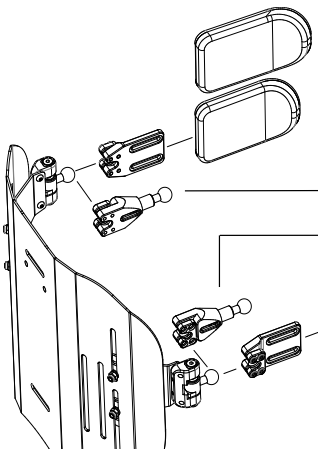

- Large (18x12)

05647 183,00

- Small (14x9)

05643 183,00

- Lateral support extension

Quantity (number pcs).....

- Lateral support extension

Quantity (number pcs).....

- Small (14x9)

05642 183,00

- Large (18x12)

05646 183,00

- Headrest adjustable - Double ball mounting system

Available only with backrest Physio
Not available for backrest Physio AIR carbon shell



- Large (34x14)

05648 252,00

- Small (28x14)

Permobil Limited Unit 7, Polaris Centre, 41 Brownfields, Welwyn Garden City, Herts, AL7 1AN United Kingdom - Phone: +44 1484 722888



customer_support_uk@permobil.com - https://www.permobil.com/en-gb

Date	Order	User	Address
------------	-------------	------------	---------------

Note

Wheelchair : Progeo EGO - Rev. 2023.1	Prices - VAT excluded to be added to the price list	<table border="1" style="width: 100%; border-collapse: collapse;"> <tr> <th colspan="2" style="text-align: left; padding: 2px;">Send this page only if any optional have been chosen</th> </tr> <tr> <td style="padding: 2px;"><input checked="" type="checkbox"/> standard</td> <td style="padding: 2px; font-size: 8px;">(supplied if no requests are indicated)</td> </tr> <tr> <td style="padding: 2px;"><input type="checkbox"/> on request</td> <td style="padding: 2px; font-size: 8px;">(without extra charge)</td> </tr> <tr> <td style="padding: 2px;"><input type="checkbox"/> optional</td> <td style="padding: 2px; font-size: 8px;">(cost to be added at the basic price)</td> </tr> </table>	Send this page only if any optional have been chosen		<input checked="" type="checkbox"/> standard	(supplied if no requests are indicated)	<input type="checkbox"/> on request	(without extra charge)	<input type="checkbox"/> optional	(cost to be added at the basic price)
Send this page only if any optional have been chosen										
<input checked="" type="checkbox"/> standard	(supplied if no requests are indicated)									
<input type="checkbox"/> on request	(without extra charge)									
<input type="checkbox"/> optional	(cost to be added at the basic price)									

REFERENCE TABLES

1		Front height			
		With closed frame (95°) max 5" caster			
		With closed frame (90°) max 5" caster			
		With closed frame (85°) max 4" caster			
		Casters			
FORK		3"	4"	5"	6"
SMALL 		max 46	max 47	max 48	
MEDIUM 		max 50	max 51	max 52	max 54
The size of the fork will be defined only by Progeo in accordance with wheelchair final configuration.					

2		Rear height			
		Rear wheels			
		22"	24"	25"	26"
min		min 35	min 38	min 39	min 40
max		max 43	max 45	max 46	max 48

3	Footplate option	Footplate distance
	Footplate COMPACT, automatic Closure	min 36
	Plastic footrest	min 36
	One piece footplate - Flip-up!	min 36
	One piece aluminium footplate - Flip-up!	min 36
	One piece Carbon fibre footplate	min 36
IMPORTANT NOTICE! From the footplate to the floor minimum 4cm !! (Minimum Front height = DP + 4cm.)		
NOTE! Lower footplate distances are possible only after our valuation		
Calculated with the best configuration and with the footplates positioned on inside.		

4	Rear wheels	
	Model	Features
	22" Ultra-light Progeo - Standard!	(not available in anthracite color)
	24" Ultra-light Progeo - Standard!	(available for all colors)
	24" ULTRA-LIGHT PROGEO KEY SPORT	(silver hub, black rim and 16 spokes)
	24" Ultra-light "Spinergy LX"	(silver hub, black rim and spokes)
	24" Ultra-light "Spinergy LXL"	(black hub and rim, 18 white spokes) - (black hub, rim and 18 spokes)
	24" Ultra-light "Spinergy Flex rim"	(silver hub, black rim and spokes) - (integrated aluminium/rubber handrim - encumbrance reduction up to 3cm. - all tyre)
	24" Off-road	(colour: black) - (aluminium handrim - tyre Off-road)
	25" Ultra-light "Spinergy LX"	(silver hub, black rim and spokes)
	25" Ultra-light "Spinergy LXL"	(black hub and rim, 18 white spokes)
	26" Progeo - Standard!	(colour: black)
	26" Ultra-light "Spinergy LX"	(silver hub, black rim and 18 spokes)

Wheelchair : Progeo EGO - Rev. 2023.1