

Permobil Limited Unit 7, Polaris Centre, 41 Brownfields, Welwyn Garden City, Herts, AL7 1AN United Kingdom - Phone: +44 1484 722888

Date	UK (English)	
User	Company stamp	Folding frame wheelchair
End user weight (kg)		£ 2290,00
Language user manual	Responsible	Retail price - VAT not included

Wheelchair measures	
Seat width (LS)	<input type="checkbox"/> 33 <input type="checkbox"/> 36 <input type="checkbox"/> 39 <input type="checkbox"/> 42 <input type="checkbox"/> 45 <input type="checkbox"/> 48
Seat depth (PS)	<input type="checkbox"/> 35 <input type="checkbox"/> 37,5 <input type="checkbox"/> 40 <input type="checkbox"/> 42,5 <input type="checkbox"/> 45 <input type="checkbox"/> 47,5
Footplate distance (DP) (cm) ±0.5cm - adjustment steps 1.5cm (Real distance between seat and footplate) - IMPORTANT NOTICE! From the footplate to the floor minimum 4cm !! (Minimum Front height = DP + 4cm.)
Setting	☆ Standard <input type="checkbox"/> Prudential <input type="checkbox"/> Active <input type="checkbox"/> Extreme
Backrest Height (TS)	Std.Value 36(min 30-max 54) adjustment steps 1.5cm
Crossbrace (black)	☆ Single <input type="checkbox"/> Double (Not seat width 33-36)
Front height	(STD 49) - Rear height

Rear frame	
Aluminium frame	<div style="display: flex; align-items: flex-start;"> <div> <p>☆ Aluminium standard frame - Same colour of front frame</p> <p>The real seat depth, from the front part of the seat cloth to the backrest tube will be 1 cm more than the declared one.</p> <p>camber ☆ 0° <input type="checkbox"/> 1,5° <input type="checkbox"/> 3°</p> </div> </div>
Aluminium frame	<div style="display: flex; align-items: flex-start;"> <div> <p><input type="radio"/> Aluminium frame DYNAMIC 2.0 - (COLOUR: BLACK) 09955 315,00</p> <p>The real seat depth, from the front part of the seat cloth to the backrest tube will be 1,5 cm more than the declared one.</p> <p>With rake adjustable backrest (±9°)</p> <p>Exclude the installation of : Brake handles for companion (Drum Brake)</p> <p>camber ☆ 0° <input type="checkbox"/> 1,5° <input type="checkbox"/> 2° <input type="checkbox"/> 4°</p> </div> </div>
Titanium frame TMAX	<div style="display: flex; align-items: flex-start;"> <div> <p>Front frame + Titanium frame T MAX 06858 687,00</p> <p>The real seat depth, from the front part of the seat cloth to the backrest tube will be 1 cm more than the declared one.</p> <p>Brushed Titanium frame - not varnished</p> <p>Weight reduction approx. 450gr</p> <p>camber ☆ 0° <input type="checkbox"/> 1,5° <input type="checkbox"/> 3°</p> </div> </div>

Front frame	
<input type="checkbox"/> Short frame - Ideal with Seat depth (PS) 35 - 37,5 <input type="checkbox"/> Medium frame - Ideal with Seat depth (PS) 40 - 42,5 <input type="checkbox"/> Long frame - Ideal with Seat depth (PS) 45 - 47,5	Frame Angle <input checked="" type="checkbox"/> 110° <input type="checkbox"/> 100°

Frame colour (aluminium)	
☆ Opaque black	<input type="checkbox"/> Bright anthracite
<input type="checkbox"/> Bright silver	<input type="checkbox"/> Bright blue
<input type="checkbox"/> Bright fuchsia	<input type="checkbox"/> Bright lime
	<input type="checkbox"/> Bright blue china
	<input type="checkbox"/> Pearl white
	<input type="checkbox"/> Bright red

Backrest
☆ Adjustable velcro straps and padded transpiring upholstery

Handle tube
☆ Tubes with standard handle
<input type="radio"/> Folding handles 02958 252,00

Colour set: Rear wheels and forks - To be matched only with: Rear wheels Ultra-light Progeo - Standard!	
☆ Polished black	22" 24" 25" 26" 00833 126,00
<input type="radio"/> Bright silver	22" 24" 00833 126,00
<input type="radio"/> Bright anthracite	24" 00833 126,00
<input type="radio"/> Bright orange	22" 24" 00833 126,00
<input type="radio"/> Bright fuchsia	22" 24" 00833 126,00
<input type="radio"/> Bright blue	22" 24" 00833 126,00
<input type="radio"/> Bright red	22" 24" 00833 126,00
<input type="radio"/> Bright lime	22" 24" 00833 126,00
<input type="radio"/> Pearl white	22" 24" 00833 126,00

















Date	Order	User	Address
------	-------	------	---------

Casters			
☆ 5" Soft			
<input type="checkbox"/> 4" Soft			
<input type="checkbox"/> 3" Sport			
<input type="checkbox"/> 6" Soft	(Available only with 110° angle)		
<input type="checkbox"/> 6" Pneumatic	(Available only with 110° angle)		
<input type="checkbox"/> 7" Soft	(Available only with 110° angle)		
<input type="checkbox"/> 3" Active Soft (wide)	(Aluminium alloy rim)	06824	126,00
<input type="checkbox"/> 4" Active Sport (narrow)	(Aluminium alloy rim)	01398	126,00
<input type="checkbox"/> 4" Active Soft (wide)	(Aluminium alloy rim)	03943	126,00
<input type="checkbox"/> 5" Active Soft (wide)	(Aluminium alloy rim)	07518	126,00
<input type="checkbox"/> 5" Pneumatic		10844	63,00

Rear wheels			
☆ 24" Ultra-light Progeo - Standard!			
<input type="checkbox"/> 22" Ultra-light Progeo - Standard!			
<input type="checkbox"/> 25" Ultra-light Progeo - Standard!	(colour: black)		
<input type="checkbox"/> 26" Progeo - Standard!	(colour: black)		
<input type="checkbox"/> 24" ULTRA-LIGHT PROGEO KEY SPORT	Weight reduction approx. 450gr.	04383	876,00
<input type="checkbox"/> 24" Ultra-light "Spinergy LX"		01685	876,00
<input type="checkbox"/> 24" Ultra-light "Spinergy LXL"	<input type="checkbox"/> Black hub and white spokes <input type="checkbox"/> Hub and spokes black	07846	876,00
<input type="checkbox"/> 24" Ultra-light "Spinergy Flex rim"	Integrated aluminium/rubber handrim	02270	1.374,00
<input type="checkbox"/> 25" Ultra-light "Spinergy LX"		02101	876,00
<input type="checkbox"/> 25" Ultra-light "Spinergy LXL"	<input type="checkbox"/> Black hub and white spokes	07847	876,00
<input type="checkbox"/> 26" Ultra-light "Spinergy LX"		02102	876,00
<input type="checkbox"/> 24" Off-road (aluminium handrim black)		01392	224,00
<input type="checkbox"/> 22" with brake handles for companion (drum brake) (aluminium handrim)		03385	360,00
Available only with camber 0°			
Not available with Frame Dynamic 2.0°			
<input type="checkbox"/> 24" with brake handles for companion (drum brake) (aluminium handrim)		03384	360,00
Available only with camber 0°			
Not available with Frame Dynamic 2.0°			
<input type="checkbox"/> One arm drive - (24" rear wheels Aluminium handrim High pressure Tyre) - camber 0°			
	<input type="checkbox"/> Right <input type="checkbox"/> Left	02103	401,00

Rear wheel tyre			
☆ High pressure tyre	(22"-24"-25"-26")		
<input type="checkbox"/> High pressure profile tyre	(24")		
<input type="checkbox"/> Marathon Plus	(24"-25")	with anti-puncture protection	01669 63,00
<input type="checkbox"/> Anti-puncture - Colour Black	(24")		11083 126,00
<input type="checkbox"/> Anti-puncture - Colour Grey	(22")		04181 98,00

Handrim	Wheel distance ☆ 3 cm □ 4 cm			
☆ Aluminium	(22"-24"-25"-26")			
<input type="checkbox"/> Aluminium black SOFT-TOUCH	(24"-25")	(24" handrim, on 25" wheel is installed with spacers)	09170	126,00
<input type="checkbox"/> Chromed Steel	(24"-25")	(24" handrim, on 25" wheel is installed with spacers)	01684	148,00
<input type="checkbox"/> Titanium	(24"-25")	(24" handrim, on 25" wheel is installed with spacers)	00016	275,00
<input type="checkbox"/> Ultra Grepp	(24"-25")	(24" handrim, on 25" wheel is installed with spacers)	00017	315,00
<input type="checkbox"/> Max Grepp	(24"-25")	(24" handrim, on 25" wheel is installed with spacers)	00834	349,00
<input type="checkbox"/> Ergo Para	(24")		00632	349,00
<input type="checkbox"/> TOP FRICTION	(24"-25")	(24" handrim, on 25" wheel is installed with spacers)	11023	399,00
Oval countour with a rubber insert				
<input type="checkbox"/> NOVA H	(24"-25")	(24" handrim, on 25" wheel is installed with spacers)	11025	263,00
Ergonomic black profile				
<input type="checkbox"/> NOVA D	(24"-25")	(24" handrim, on 25" wheel is installed with spacers)	11026	286,00
Ergonomic profile with rubber coating (ideal for quadriplegics)				
<input type="checkbox"/> SURGE LT	(25")	Oval countour with a rubber insert	06427	360,00
<input type="checkbox"/> Quad	(24")		00693	200,00
<input type="checkbox"/> Silicon cover for standard aluminium handrim	Available for measures (22" - 24" - 26")		04050	160,00

Date	Order	User	Address
Wheel locks			
<input checked="" type="checkbox"/> Bent lever push to lock			
<input type="checkbox"/> Straight lever push to lock <input type="checkbox"/> Straight lever pull to lock		 	
<input type="checkbox"/> Sport brake			
<input type="checkbox"/> Brake with extension lever push to lock <input type="checkbox"/> Brake with extension lever pull to lock		 	
		06428	126,00
		01949	63,00
		03372	63,00
Footplate - See reference tables N°3			
<input checked="" type="checkbox"/> Plastic footrest, rake adjustable (Minimum footplate distance 33cm.)		<input checked="" type="checkbox"/> 2/3 Internal <input type="checkbox"/> 2/3 External	
			
<input type="checkbox"/> Automatic Closure footplate , rake and depth adjustable (Minimum footplate distance 30cm.)		<input type="checkbox"/> Internal <input checked="" type="checkbox"/> 2/3 Internal <input type="checkbox"/> External	
			
<input type="checkbox"/> Minimum footplate distance 25cm. Available only with Multi-function and rotative system - 03945		189,00	
<input type="checkbox"/> One piece footplate - Flip-up! rake and depth adjustable (Minimum footplate distance 30cm.)		<input type="checkbox"/> Internal <input checked="" type="checkbox"/> 2/3 Internal <input type="checkbox"/> External	
			
<input type="checkbox"/> Minimum footplate distance 25cm. Available only with Multi-function and rotative system - 03945		189,00	
<input type="checkbox"/> One piece aluminium footplate - Flip-up! rake and depth adjustable (Minimum footplate distance 30cm.)		<input type="checkbox"/> Internal <input checked="" type="checkbox"/> 2/3 Internal <input type="checkbox"/> 2/3 External <input type="checkbox"/> External	
			
<input type="checkbox"/> One piece Carbon fibre footplate rake adjustable, swing away, flip-up. (Minimum footplate distance 30cm.)		<input checked="" type="checkbox"/> Internal <input type="checkbox"/> External	
			
<input type="checkbox"/> Footplate COMPACT, automatic Closure, rake and depth adjustable Minimum footplate distance 35cm.		<input checked="" type="checkbox"/> Internal <input type="checkbox"/> External	
			
		03291	275,00
		09957	252,00
Mudguard			
Mudguard - FIXED			
<input checked="" type="checkbox"/> ABS mudguard			
<input type="checkbox"/> ABS Straight sideguard			
<input type="checkbox"/> Carbon fibre mudguard		03946 315,00	
<input type="checkbox"/> Carbon fibre Straight sideguard		08918 315,00	
Mudguard - REMOVABLE			
<input type="checkbox"/> Removable ABS mudguard		08921 126,00	
<input type="checkbox"/> Removable ABS fibre straight sideguard		08921 126,00	
<input type="checkbox"/> Removable carbon fibre mudguard		08919 435,00	
<input type="checkbox"/> Removable Carbon fibre straight sideguard		08920 435,00	
Armrests			
<input type="checkbox"/> Tubular armrests		(Swing away, removable and height adjustable armrest) <input type="checkbox"/> Standard Support (Not with frame Dynamic) <input type="checkbox"/> Steel support with safety locking system	
			
		04828	177,00
		00694	252,00
Removable armrest with ABS mudguard			
<input type="checkbox"/> Desk armrests PROGEO		(Removable and height adjustable) Not available with Frame Dynamic 2.0 + camber 4°	
			
		09956	224,00
<input type="checkbox"/> Removable armrest with ABS straight sideguard			
		08881	224,00
<input type="checkbox"/> Removable armrest with carbon-fiber straight sideguard			
		08882	453,00







Date	Order	User	Address
Accessories			
<input type="checkbox"/>	Pad for front frame protectors		07058 52,00
<input type="checkbox"/>	Backrest-seat connection cloth		10241 17,00
<input type="checkbox"/>	Removable storage bag (with quick coupling)		09811 126,00
Optional 1			
<input type="checkbox"/>	Transit wheels		00836 148,00
<input type="checkbox"/>	Anti-tipper with rapid hookup	(inside rotation to reduce the encumbrance) <input type="checkbox"/> Right <input type="checkbox"/> Left	00023 126,00 00024 126,00
<input type="checkbox"/>	Tipping aid	<input type="checkbox"/> Right <input type="checkbox"/> Left	00025 74,00 01046 74,00
<input type="checkbox"/>	Crutches support	<input type="checkbox"/> Right <input type="checkbox"/> Left	00838 74,00 00837 74,00
Optional 2			
<input type="checkbox"/>	Tetraclip	(Quick release axle for quadriplegic)	03947 177,00
<input type="checkbox"/>	Rear wheels plate extension	(Not with frame Dynamic 2.0)	01950 177,00
<input type="checkbox"/>	Handybike adaptor	(Not with frame Dynamic 2.0)	00506 74,00
<input type="checkbox"/>	Push handles for companion	(Removable and height adjustable)	01048 189,00
<input type="checkbox"/>	Harness		04103 126,00
<input type="checkbox"/>	Safety pelvic belt		03972 63,00
<input type="checkbox"/>	Tray table (removable)		00508 275,00
<input type="checkbox"/>	Lumbar support	(to insert in the backrest upholstery)	00013 40,00
<input type="checkbox"/>	Super Head rest	(Folding with the wheelchair)	04049 453,00
<input type="checkbox"/>	Swing away lateral support	<input type="checkbox"/> Right <input type="checkbox"/> Left	02097 252,00 02098 252,00
	Not available with Posture backrest PHYSIO		
<input type="checkbox"/>	Spoke guards Black	(22"-24")	01043 148,00
<input type="checkbox"/>	Spoke guards Transparent	(22"-24")	00835 148,00
<input type="checkbox"/>	Spoke guards Progeo design	(22"-24")	00019 177,00
<input type="checkbox"/>	Spoke guards Dragon	(22"-24")	02106 177,00
Additional Kit			
<input type="checkbox"/>	24" Off-road rear wheels	Off-Road tyre - aluminium handrim (black colour)	03378 498,00
<input type="checkbox"/>	24" FAT rear wheels	FAT tyre 3" - aluminium handrim (black colour)	09357 876,00

Date Order User Address

PHYSIO - Posture backrest - Std. Backrest upholstery not provided

Removable with quick release
 Suitable for tubes with diameter 18±26mm
 Depth adjustment (4cm)
 Angle adjustment (±18°)

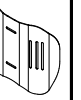
- AIR** Carbon shell
 not available for seat width 48

BACKREST HEIGHT	28	34	40			
Shell's shape 	Lateral retaining wing A=high - R=regular					
	A	R	A	R	A	R
						
	<input type="checkbox"/>	<input type="checkbox"/>	<input type="checkbox"/>	<input type="checkbox"/>	<input type="checkbox"/>	<input type="checkbox"/>

1.047,00

- POSTURE** Aluminum shell

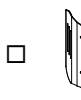
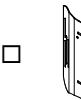
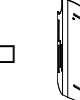
BACKREST HEIGHT	34	40	52			
Shell's shape 	Lateral retaining wing B=regular					
	R	R	R			
						
	<input type="checkbox"/>	<input type="checkbox"/>	<input type="checkbox"/>			

1.013,00

Configuration DEEP with side support PAD (height adjustable)

- Aluminum lateral with padded, breathable upholstery.



Small (h 13cm)



- Right 10272

29,00



- Left 10272

29,00

Large (h 20cm)



- Right 10273

40,00



- Left 10273

40,00

SWING AWAY - Lateral support

Fixing and adjustment hardware complete with protection sleeve
 Aluminum lateral with padded, breathable upholstery.

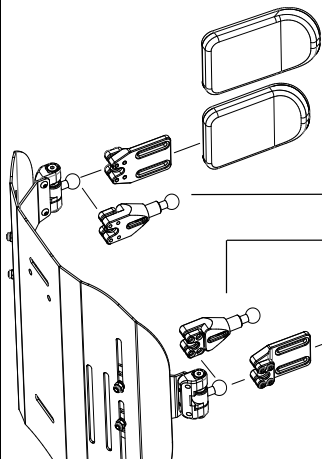

- Large (18x12)

05647 183,00

- Small (14x9)

05643 183,00

- Lateral support extension

Quantity (number pcs)..... 10271 69,00

- Lateral support extension

Quantity (number pcs).....

- Small (14x9)

05642 183,00

- Large (18x12)

05646 183,00

- Headrest adjustable - Double ball mounting system
 Available only with backrest Physio
 Not available for backrest Physio AIR carbon shell

- Large (34x14)
- Small (28x14)



05648 252,00



Date	Order	User	Address
------	-------	------	---------

Note

Wheelchair : Progeo EXELLE - Rev. 2023.1	Prices - VAT excluded to be added to the price list	Send this page only if any optional have been chosen <input checked="" type="checkbox"/> standard (supplied if no requests are indicated) <input type="checkbox"/> on request (without extra charge) <input type="checkbox"/> optional (cost to be added at the basic price)
--	--	--

REFERENCE TABLES

1	Front height		
With closed frame (95°) max 5" caster			
Casters	Front height		
	min.	max	
3"	41	52	
4"	42	53	
5"	44	54	
6"	48	55	
7"	49	56	
The size of the fork will be defined only by Progeo in accordance with wheelchair final configuration.			

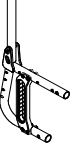
2	Rear height				
	Rear frame	Rear wheels			
		22"	24"	25"	26"
STANDARD	Straight plate 	min. 37 max 45	min. 39 max 47	min. 40 max 48	min 41 max 49
	Shaped plate 	min. 36 max 49	min. 38 max 51	min. 39 max 52	min. 40 max 53
DYNAMIC 2.0 		min. 36 max 49	min. 38 max 51	min. 39 max 52	min. 40 max 53

3	Footplate option	Footplate distance	
		Frame Angle 110°	Frame Angle 100°
	Plastic footrest	min. 33	min. 31
	Automatic Closure footplate	min. 30	min. 28
	Automatic Closure footplate , with multifunction rotative system	min. 25	min. 23
	One piece footplate - Flip-up!	min. 30	min. 28
	One piece footplate - Flip-up! , with multifunction rotative system	min. 25	min. 23
	One piece aluminium footplate - Flip-up!	min. 30	min. 28
	One piece Carbon fibre footplate	min. 30	min. 28
Calculated with the best configuration and with the footplates positioned on inside.			
IMPORTANT NOTICE! From the footplate to the floor minimum 4cm !! (Minimum Front height = DP + 4cm.)			

4	Rear wheels	
	Model	Features
	22" Ultra-light Progeo - Standard!	(not available in anthracite color)
	24" Ultra-light Progeo - Standard!	(available for all colors)
	24" ULTRA-LIGHT PROGEO KEY SPORT	(silver hub, black rim and 16 spokes)
	24" Ultra-light "Spinergy LX"	(silver hub, black rim and spokes)
	24" Ultra-light "Spinergy LXL"	(black hub and rim, 18 white spokes) - (black hub, rim and 18 spokes)
	24" Ultra-light "Spinergy Flex rim"	(silver hub, black rim and spokes) - (integrated aluminium/rubber handrim - encumbrance reduction up to 3cm. - all tyre)
	24" Off-road	(colour: black) - (aluminium handrim - tyre Off-road)
	25" Ultra-light "Spinergy LX"	(silver hub, black rim and spokes)
	25" Ultra-light "Spinergy LXL"	(black hub and rim, 18 white spokes)
	26" Progeo - Standard!	(colour: black)
	26" Ultra-light "Spinergy LX"	(silver hub, black rim and 18 spokes)

Wheelchair : Progeo EXELLE - Rev. 2023.1