

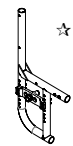

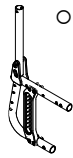
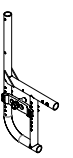

Date	UK (English)	CRASH TEST APPROVED
User	Company stamp	Folding frame wheelchair
End user weight (kg)		£ 2404,00
Language user manual	Responsible	Retail price - VAT not included

Wheelchair measures	
Seat width (LS)	<input type="checkbox"/> 33 <input type="checkbox"/> 36 <input type="checkbox"/> 39 <input type="checkbox"/> 42 <input type="checkbox"/> 45 <input type="checkbox"/> 48
Seat depth (PS)	<input type="checkbox"/> 35 <input type="checkbox"/> 37,5 <input type="checkbox"/> 40 <input type="checkbox"/> 42,5 <input type="checkbox"/> 45 <input type="checkbox"/> 47,5
Footplate distance (DP) (cm) ±0.5cm - adjustment steps 1.5cm (Real distance between seat and footplate) - IMPORTANT NOTICE! From the footplate to the floor minimum 4cm !! (Minimum Front height = DP + 4cm.)
Setting	☆ Standard <input type="checkbox"/> Prudential <input type="checkbox"/> Active <input type="checkbox"/> Extreme
Backrest Height (TS)	Std.Value 36(min 30-max 54) adjustment steps 1.5cm
Crossbrace (black)	☆ Single <input type="checkbox"/> Double (Not seat width 33-36)
Front height	(STD 49) - Rear height (STD 44)

SAFETY <input type="checkbox"/> 4 points tie-down system rings NOT AVAILABLE WITH: Aluminium frame DYNAMIC 2.0 - Titanium frame T MAX	 08654 189,00
---	--

Rear frame	
Aluminium frame	<div style="display: flex; align-items: flex-start;">  <div> <p>☆ Aluminium standard frame - Same colour of front frame</p> <p>The real seat depth, from the front part of the seat cloth to the backrest tube will be 1 cm more than the declared one.</p> <p>camber ☆ 0° <input type="checkbox"/> 1,5° <input type="checkbox"/> 3°</p> </div> </div>
Aluminium frame	<div style="display: flex; align-items: flex-start;">  <div> <p><input type="checkbox"/> Aluminium frame DYNAMIC 2.0 - (COLOUR: BLACK) 09955 315,00</p> <p>The real seat depth, from the front part of the seat cloth to the backrest tube will be 1,5 cm more than the declared one. With rake adjustable backrest (±9°) Exclude the installation of : Brake handles for companion (Drum Brake) - 4 points tie-down system rings</p> <p>camber ☆ 0° <input type="checkbox"/> 1,5° <input type="checkbox"/> 2° <input type="checkbox"/> 4°</p> </div> </div>
Titanium frame TMAX	<div style="display: flex; align-items: flex-start;">  <div> <p>Titanium frame T MAX 03940 372,00</p> <p>The real seat depth, from the front part of the seat cloth to the backrest tube will be 1 cm more than the declared one. Brushed Titanium frame - not varnished Weight reduction approx. 250gr Exclude the installation of : 4 points tie-down system rings</p> <p>camber ☆ 0° <input type="checkbox"/> 1,5° <input type="checkbox"/> 3°</p> </div> </div>

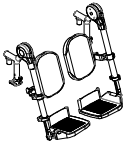
Front frame <input type="checkbox"/> Short frame - Ideal with Seat depth (PS) 35 - 37,5 <input type="checkbox"/> Medium frame - Ideal with Seat depth (PS) 40 - 42,5 <input type="checkbox"/> Long frame - Ideal with Seat depth (PS) 45 - 47,5	Frame Angle	 ☆ 110°	 <input type="checkbox"/> 120°	 <input type="checkbox"/> 95°
<input type="checkbox"/> Elevating front frame, swing away and removable Include calf supports and plastic footrest with heel band (not available for seat width 33) Minimum footplate distance 25cm.				09730 252,00

Frame colour (aluminium)	
☆ Opaque black	<input type="checkbox"/> Bright silver <input type="checkbox"/> Bright anthracite <input type="checkbox"/> Bright blue <input type="checkbox"/> Bright blue china
<input type="checkbox"/> Bright fuchsia	<input type="checkbox"/> Bright orange <input type="checkbox"/> Bright lime <input type="checkbox"/> Pearl white <input type="checkbox"/> Bright red

Backrest
☆ Adjustable velcro straps and padded transpiring upholstery

Handle tube ☆ Tubes with standard handle <input type="checkbox"/> Folding handles	 02958 252,00
--	---

Date Order User Address

Colour set: Rear wheels and forks - To be matched only with: Rear wheels Ultra-light Progeo - Standard!

<input checked="" type="radio"/> Black	22" 24" 25" 26"		
<input type="radio"/> Bright silver	22" 24"	00833	126,00
<input type="radio"/> Bright anthracite	24"	00833	126,00
<input type="radio"/> Bright orange	22" 24"	00833	126,00
<input type="radio"/> Bright fuchsia	22" 24"	00833	126,00
<input type="radio"/> Bright blue	22" 24"	00833	126,00
<input type="radio"/> Bright red	22" 24"	00833	126,00
<input type="radio"/> Bright lime	22" 24"	00833	126,00
<input type="radio"/> Pearl white	22" 24"	00833	126,00

Casters

<input checked="" type="radio"/> 5" Soft			
<input type="checkbox"/> 4" Soft			
<input type="checkbox"/> 3" Sport			
<input type="checkbox"/> 6" Soft	Not available with frame angle 95°		
<input type="checkbox"/> 6" Pneumatic	Not available with frame angle 95°		
<input type="checkbox"/> 7" Soft	Not available with frame angle 95°		
<input type="radio"/> 3" Active Soft (wide)	(Aluminium alloy rim)	06824	126,00
<input type="radio"/> 4" Active Sport (narrow)	(Aluminium alloy rim)	01398	126,00
<input type="radio"/> 4" Active Soft (wide)	(Aluminium alloy rim)	03943	126,00
<input type="radio"/> 5" Active Soft (wide)	(Aluminium alloy rim)	07518	126,00
<input type="radio"/> 5" Pneumatic		10844	63,00

Rear wheels

<input checked="" type="radio"/> 24" Ultra-light Progeo - Standard!			
<input type="checkbox"/> 22" Ultra-light Progeo - Standard!			
<input type="checkbox"/> 25" Ultra-light Progeo - Standard!	(colour: black)		
<input type="checkbox"/> 26" Progeo - Standard!	(colour: black)		
<input type="radio"/> 24" ULTRA-LIGHT PROGEO KEY SPORT	Weight reduction approx. 450gr.	04383	876,00
<input type="radio"/> 24" Ultra-light "Spinergy LX"		01685	876,00
<input type="radio"/> 24" Ultra-light "Spinergy LXL"	<input type="checkbox"/> Black hub and white spokes <input type="checkbox"/> Hub and spokes black	07846	876,00
<input type="radio"/> 24" Ultra-light "Spinergy Flex rim"	Integrated aluminium/rubber handrim	02270	1.374,00
<input type="radio"/> 25" Ultra-light "Spinergy LX"		02101	876,00
<input type="radio"/> 25" Ultra-light "Spinergy LXL"	<input type="checkbox"/> Black hub and white spokes	07847	876,00
<input type="radio"/> 26" Ultra-light "Spinergy LX"		02102	876,00
<input type="radio"/> 24" Off-road (aluminium handrim black)		01392	224,00
<input type="radio"/> 22" with brake handles for companion (drum brake) (aluminium handrim)		03385	360,00
Available only with camber 0°			
Not available with Frame Dynamic 2.0			
<input type="radio"/> 24" with brake handles for companion (drum brake) (aluminium handrim)		03384	360,00
Available only with camber 0°			
Not available with Frame Dynamic 2.0			
<input type="radio"/> One arm drive - (24" rear wheels Aluminium handrim High pressure Tyre) - camber 0°	<input type="radio"/> Right <input type="radio"/> Left	02103	401,00

Rear wheel tyre







<input checked="" type="radio"/> High pressure tyre	(22"-24"-25"-26")		
<input type="checkbox"/> High pressure profile tyre	(24")		
<input type="radio"/> Marathon Plus	(24"-25")	with anti-puncture protection	01669 63,00
<input type="radio"/> Anti-puncture - Colour Black	(24")		11083 126,00
<input type="radio"/> Anti-puncture - Colour Grey	(22")		04181 98,00



Handrim

Wheel distance 3 cm 4 cm

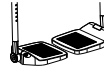
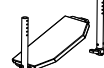

<input checked="" type="radio"/> Aluminium	(22"-24"-25"-26")		
<input type="radio"/> Aluminium black SOFT-TOUCH	(24"-25")	(24" handrim, on 25" wheel is installed with spacers)	09170 126,00
<input type="radio"/> Chromed Steel	(24"-25")	(24" handrim, on 25" wheel is installed with spacers)	01684 148,00
<input type="radio"/> Titanium	(24"-25")	(24" handrim, on 25" wheel is installed with spacers)	00016 275,00
<input type="radio"/> Ultra Grepp	(24"-25")	(24" handrim, on 25" wheel is installed with spacers)	00017 315,00
<input type="radio"/> Max Grepp	(24"-25")	(24" handrim, on 25" wheel is installed with spacers)	00834 349,00
<input type="radio"/> Ergo Para	(24")		00632 349,00
<input type="radio"/> TOP FRICTION	(24"-25")	(24" handrim, on 25" wheel is installed with spacers)	11023 399,00
Oval countour with a rubber insert			
<input type="radio"/> NOVA H	(24"-25")	(24" handrim, on 25" wheel is installed with spacers)	11025 263,00
Ergonomic black profile			
<input type="radio"/> NOVA D	(24"-25")	(24" handrim, on 25" wheel is installed with spacers)	11026 286,00
Ergonomic profile with rubber coating (ideal for quadriplegics)			
<input type="radio"/> SURGE LT	(25")	Oval countour with a rubber insert	06427 360,00
<input type="radio"/> Quad	(24")		00693 200,00
<input type="radio"/> Silicon cover for standard aluminium handrim		Available for measures (22"- 24" - 26")	04050 160,00

Date Order User Address

Wheel locks				
<input checked="" type="checkbox"/>	Bent lever push to lock			
<input type="checkbox"/>	Straight lever push to lock			
<input type="checkbox"/>	Straight lever pull to lock			
<input type="checkbox"/>	Sport brake		06428	126,00
<input type="checkbox"/>	Brake with extension lever push to lock		01949	63,00
<input type="checkbox"/>	Brake with extension lever pull to lock		03372	63,00

Footplate (Not available with Elevating front frame, swing away and removable) - See reference tables N°3				
<input checked="" type="checkbox"/>	Plastic footrest, rake adjustable Not available with Elevating front frame, swing away and removable Minimum footplate distance 27cm. <input checked="" type="checkbox"/> 2/3 Internal <input type="checkbox"/> 2/3 External		11525	no list
<input type="checkbox"/>	One piece footplate - Flip-up! rake and depth adjustable Not available with Elevating front frame, swing away and removable Minimum footplate distance 26cm. <input type="checkbox"/> Internal <input checked="" type="checkbox"/> 2/3 Internal <input type="checkbox"/> External		11527	no list
<input type="checkbox"/>	Minimum footplate distance 21cm. Available only with Multi-function and rotative system - 03945		189,00	
<input type="checkbox"/>	One piece aluminium footplate - Flip-up! rake and depth adjustable Not available with Elevating front frame, swing away and removable Minimum footplate distance 26cm. <input type="checkbox"/> Internal <input checked="" type="checkbox"/> 2/3 Internal <input type="checkbox"/> 2/3 External <input type="checkbox"/> External		11528	no list
<input type="checkbox"/>	One piece Carbon fibre footplate rake adjustable, swing away, flip-up. Not available with Elevating front frame, swing away and removable Minimum footplate distance 26cm. <input checked="" type="checkbox"/> Internal <input type="checkbox"/> External		03291	275,00

Mudguard				
Mudguard - FIXED				
<input checked="" type="checkbox"/>	ABS mudguard			
<input type="checkbox"/>	ABS Straight sideguard			
<input type="checkbox"/>	Carbon fibre mudguard		03946	315,00
<input type="checkbox"/>	Carbon fibre Straight sideguard		08918	315,00
Mudguard - REMOVABLE				
<input type="checkbox"/>	Removable ABS mudguard		08921	126,00
<input type="checkbox"/>	Removable ABS fibre straight sideguard		08921	126,00
<input type="checkbox"/>	Removable carbon fibre mudguard		08919	435,00
<input type="checkbox"/>	Removable Carbon fibre straight sideguard		08920	435,00





Armrests				
<input type="checkbox"/>	Tubular armrests	(Swing away, removable and height adjustable armrest) <input type="checkbox"/> Standard Support (Not with frame Dynamic) <input type="checkbox"/> Steel support with safety locking system		04828 177,00 00694 252,00
Removable armrest with ABS mudguard				
<input type="checkbox"/>	Desk armrests PROGEO	(Removable and height adjustable) Not available with Frame Dynamic 2.0 + camber 4°		09956 224,00
<input type="checkbox"/>	Removable armrest with ABS straight sideguard			08881 224,00
<input type="checkbox"/>	Removable armrest with carbon-fiber straight sideguard			08882 453,00

Date Order User Address



Accessories

<input type="checkbox"/> Pad for front frame protectors		07058	52,00
<input type="checkbox"/> Backrest-seat connection cloth		10241	17,00
<input type="checkbox"/> Removable storage bag (with quick coupling)		09811	126,00

Optional 1

<input type="checkbox"/> Transit wheels			00836	148,00
<input type="checkbox"/> Anti-tipper with rapid hookup	(inside rotation to reduce the encumbrance)			
	<input type="checkbox"/> Right		00023	126,00
	<input type="checkbox"/> Left		00024	126,00
<input type="checkbox"/> Tipping aid	<input type="checkbox"/> Right		00025	74,00
	<input type="checkbox"/> Left		01046	74,00
<input type="checkbox"/> Crutches support	<input type="checkbox"/> Right		00838	74,00
	<input type="checkbox"/> Left		00837	74,00

Optional 2

<input type="checkbox"/> Tetracrip	(Quick release axle for quadriplegic)		03947	177,00
<input type="checkbox"/> Rear wheels plate extension	(Not with frame Dynamic 2.0)		01950	177,00
<input type="checkbox"/> Handybike adaptor	(Not with frame Dynamic 2.0)		00506	74,00
<input type="checkbox"/> Push handles for companion	(Removable and height adjustable)		01048	189,00
<input type="checkbox"/> Harness			04103	126,00
<input type="checkbox"/> Safety pelvic belt			03972	63,00
<input type="checkbox"/> Tray table (removable)			00508	275,00
<input type="checkbox"/> Lumbar support	(to insert in the backrest upholstery)		00013	40,00
<input type="checkbox"/> Super Head rest	(Folding with the wheelchair)		04049	453,00
<input type="checkbox"/> Swing away lateral support	<input type="checkbox"/> Right		02097	252,00
Not available with Posture backrest PHYSIO	<input type="checkbox"/> Left		02098	252,00
<input type="checkbox"/> Spoke guards Black	(22"-24")		01043	148,00
<input type="checkbox"/> Spoke guards Transparent	(22"-24")		00835	148,00
<input type="checkbox"/> Spoke guards Progeo design	(22"-24")		00019	177,00
<input type="checkbox"/> Spoke guards Dragon	(22"-24")		02106	177,00

Additional Kit







<input type="checkbox"/> 24" Off-road rear wheels	Off-Road tyre - aluminium handrim (black colour)	03378	498,00
<input type="checkbox"/> 24" FAT rear wheels	FAT tyre 3" - aluminium handrim (black colour)	09357	876,00

Date Order User Address

PHYSIO - Posture backrest (Std. Backrest upholstery not provided)





Removable with quick release
Suitable for tubes with diameter 18÷26mm
Depth adjustment (4cm)
Angle adjustment (±18°)

- AIR** Carbon shell
not available for seat width 48

BACKREST HEIGHT	28	34	40			
Shell's shape  7.5 cm	Lateral retaining wing A=high - R=regular					
	A	R	A	R	A	R
						
	<input type="checkbox"/>	<input type="checkbox"/>	<input type="checkbox"/>	<input type="checkbox"/>	<input type="checkbox"/>	<input type="checkbox"/>

1.047,00

- POSTURE** Aluminum shell

BACKREST HEIGHT	34	40	52			
Shell's shape  7.5 cm	Lateral retaining wing B=regular					
	R	R	R			
						
	<input type="checkbox"/>	<input type="checkbox"/>	<input type="checkbox"/>			

1.013,00

Configuration DEEP with side support PAD (height adjustable)

- Aluminum lateral with padded, breathable upholstery.



Small (h 13cm)



Right
10272

29,00



Left
10272

29,00

Large (h 20cm)



Right
10273

40,00



Left
10273

40,00

SWING AWAY - Lateral support

Fixing and adjustment hardware complete with protection sleeve
Alluminum lateral with padded, breathable upholstery.

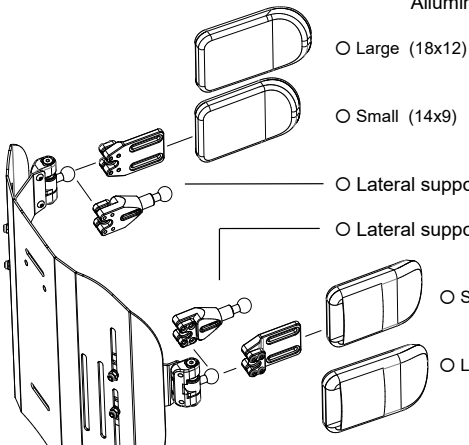

- Large (18x12)

05647 183,00

- Small (14x9)

05643 183,00

- Lateral support extension

Quantity (number pcs).....

- Lateral support extension

Quantity (number pcs).....

- Small (14x9)

05642 183,00

- Large (18x12)

05646 183,00

- Headrest adjustable - Double ball mounting system
Available only with backrest Physio
Not available for backrest Physio AIR carbon shell

- Large (34x14)
- Small (28x14)



05648 252,00

Permobil Limited Unit 7, Polaris Centre, 41 Brownfields, Welwyn Garden City, Herts, AL7 1AN United Kingdom - Phone: +44 1484 722888

customer_support_uk@permobil.com - https://www.permobil.com/en-gb

Date	Order	User	Address
------------	-------------	------------	---------------

Note



Wheelchair : Progeo EXELLE VARIO - Rev. 2023.1

Prices - VAT excluded
to be added to the price list

Send this page only if any optional have been chosen	
<input checked="" type="checkbox"/>	standard <small>(supplied if no requests are indicated)</small>
<input type="checkbox"/>	on request <small>(without extra charge)</small>
<input type="checkbox"/>	optional <small>(cost to be added at the basic price)</small>

REFERENCE TABLES

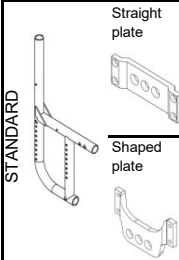
1	Front height	
With closed frame (95°) max 5" caster		
Casters	Front height	
	min.	max
3"	41	52
4"	42	53
5"	44	54
6"	48	55
7"	49	56
The size of the fork will be defined only by Progeo in accordance with wheelchair final configuration.		

2	Rear height			
Rear frame	Rear wheels			
	22"	24"	25"	26"
STANDARD 	Straight plate min. 37 max 45	min. 39 max 47	min. 40 max 48	min 41 max 49
	Shaped plate min. 36 max 49	min. 38 max 51	min. 39 max 52	min. 40 max 53
DYNAMIC 2.0 	min. 36 max 49	min. 38 max 51	min. 39 max 52	min. 40 max 53

3	Footplate option	Frame Angle 110°	Footplate distance Frame Angle 120°	Frame Angle 95°
	Plastic footrest	min. 27	min. 27	min. 27
	One piece footplate - Flip-up!	min. 24	min. 26	min. 24
	One piece footplate - Flip-up! with multifunction rotative system	min. 19	min. 21	min. 19
	One piece aluminium footplate - Flip-up!	min. 24	min. 26	min. 24
	One piece Carbon fibre footplate	min. 24	min. 26	min. 24
Calculated with the best configuration and with the footplates positioned on inside.				
IMPORTANT NOTICE! From the footplate to the floor minimum 4cm !! (Minimum Front height = DP + 4cm.)				

4	Rear wheels	
Model	Features	
22" Ultra-light Progeo - Standard!	(not available in anthracite color)	
24" Ultra-light Progeo - Standard!	(available for all colors)	
24" ULTRA-LIGHT PROGEO KEY SPORT	(silver hub, black rim and 16 spokes)	
24" Ultra-light "Spinergy LX"	(silver hub, black rim and spokes)	
24" Ultra-light "Spinergy LXL"	(black hub and rim, 18 white spokes) - (black hub, rim and 18 spokes)	
24" Ultra-light "Spinergy Flex rim"	(silver hub, black rim and spokes) - (integrated aluminium/rubber handrim - encumbrance reduction up to 3cm. - all tyre)	
24" Off-road	(colour: black) - (aluminium handrim - tyre Off-road)	
25" Ultra-light "Spinergy LX"	(silver hub, black rim and spokes)	
25" Ultra-light "Spinergy LXL"	(black hub and rim, 18 white spokes)	
26" Progeo - Standard!	(colour: black)	
26" Ultra-light "Spinergy LX"	(silver hub, black rim and 18 spokes)	

Wheelchair : Progeo EXELLE VARIO - Rev. 2023.1