

# permobil Order Form - Progeo JOKER

UK (English)

Date .....

Company stamp

Rigid frame wheelchair  
CRASH TEST APPROVED

User .....

End user weight (kg) .....

£ 2592,00

Language user manual .....

Responsible .....

Retail price - VAT not included



Permobil Limited Unit 7, Polaris Centre, 41 Brownfields, Welwyn Garden City, Herts, AL7 1AN United Kingdom - Phone: +44 1484 722888

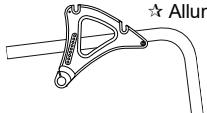

customer\_support\_uk@permobil.com - https://www.permobil.com/en-gb

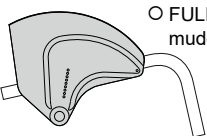
Wheelchair measures						
Seat width (LS)	<input type="checkbox"/> 33	<input type="checkbox"/> 36	<input type="checkbox"/> 39	<input type="checkbox"/> 42	<input type="checkbox"/> 45	<input type="checkbox"/> 48
Seat depth (PS)	<input type="checkbox"/> 35	<input type="checkbox"/> 37,5	<input type="checkbox"/> 40	<input type="checkbox"/> 42,5	<input type="checkbox"/> 45	<input type="checkbox"/> 47,5 <input type="checkbox"/> 50
The real seat depth, from the front part of the seat cloth to the backrest tube will be 1,5 cm more than the declared one.						
Footplate distance (DP)	..... (cm) ±0.5cm - adjustment steps 1.5cm <b>(Real distance between seat and footplate) - IMPORTANT NOTICE! From the footplate to the floor minimum 4cm !! (Minimum Front height = DP + 4cm.)</b>					
Setting	<input checked="" type="checkbox"/> Standard	<input type="checkbox"/> Prudential	<input type="checkbox"/> Active	<input type="checkbox"/> Extreme		
Backrest Height (TS)	Std.Value 33,5 .....(min 24.5-max 47) adjustment steps 1.5cm					
camber	<input checked="" type="checkbox"/> 0°	<input type="checkbox"/> 2°	<input type="checkbox"/> 4°			
Front height STD 49	.....		Rear height STD 42	.....		

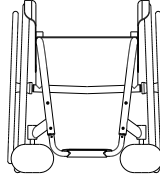
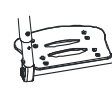
	<ul style="list-style-type: none"> <li>☆ Aluminum rear adjustment plate</li> <li>☆ Removable mudguard ABS</li> <li><input type="checkbox"/> Removable ABS fibre straight sideguard</li> <li><input type="radio"/> Removable carbon fibre mudguard <span style="float: right;">03946 <b>315,00</b></span></li> <li><input type="radio"/> Removable Carbon fibre straight sideguard <span style="float: right;">08918 <b>315,00</b></span></li> </ul>
--	---

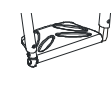
	<ul style="list-style-type: none"> <li><input type="radio"/> FULL CARBON rear adjustment plate with integrated mudguard <span style="float: right;">07646 <b>939,00</b></span></li> <li>☆ Version mudguard (Available only with rear wheels 24")</li> <li><input type="checkbox"/> Version straight sideguard</li> </ul>
---	--

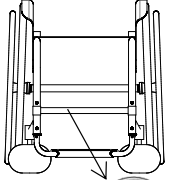
<b>JOKER</b>		<ul style="list-style-type: none"> <li>☆ Aluminium footplate, rake adjustable Minimum footplate distance 35cm.</li> <li>☆ Internal <input type="checkbox"/> 2/3 Internal</li> <li><input type="checkbox"/> External <input type="checkbox"/> 2/3 External</li> </ul>		11523	<b>no list</b>
		<ul style="list-style-type: none"> <li><input type="radio"/> Aluminium footplate EVOLUTION - rake and depth adjustable Minimum footplate distance 35cm.</li> <li>☆ Internal <input type="checkbox"/> 2/3 Internal</li> <li><input type="checkbox"/> External <input type="checkbox"/> 2/3 External</li> </ul>		07649	<b>126,00</b>
		<ul style="list-style-type: none"> <li><input type="radio"/> One piece Carbon fibre footplate JOKER Minimum footplate distance 35cm. not available for seat width 48</li> </ul>		03348	<b>252,00</b>
		<ul style="list-style-type: none"> <li><input type="radio"/> One piece Carbon fibre footplate, rake adjustable Minimum footplate distance 35cm.</li> <li>☆ Internal <input type="checkbox"/> External</li> </ul>		03346	<b>298,00</b>

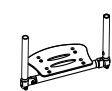
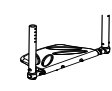
<b>JOKER ZERO</b>		<ul style="list-style-type: none"> <li><input type="radio"/> Plastic footrest, rake adjustable Minimum footplate distance 15cm.</li> <li>☆ 2/3 Internal <input type="checkbox"/> 2/3 External</li> </ul>		06814	<b>189,00</b>
		<ul style="list-style-type: none"> <li><input type="radio"/> One piece aluminium footplate - Flip-up!, rake and depth adjustable Minimum footplate distance 15cm.</li> <li>☆ Internal <input type="checkbox"/> 2/3 Internal</li> <li><input type="checkbox"/> External <input type="checkbox"/> 2/3 External</li> </ul>		06856	<b>189,00</b>
		<ul style="list-style-type: none"> <li><input type="radio"/> One piece Carbon fibre footplate rake adjustable, swing away, flip-up. Minimum footplate distance 15cm.</li> <li>☆ Internal <input type="checkbox"/> External</li> </ul>		06857	<b>487,00</b>

Date ..... Order ..... User ..... Address .....

### Front frame

☆ Aluminium standard frame

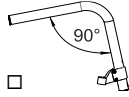
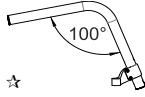

### Colour aluminium frame

☆ Bright silver

- Polished black
- Opaque black

- Bright blue
- Bright anthracite

- Bright orange
- Bright fuchsia
- Bright red

- Bright lime
- Bright blue china
- Pearl white

### Seat

☆ Seat cloth with pocket (under seat)

- Seat with tension straps 08883 **224,00**
- Carbon rigid seat 08336 **475,00**
  - Pocket (under seat) [25x11x4,5] 08281 **74,00**

### Rear wheels axle

- ☆ Aluminum rear wheels axle
- Carbon fiber rear wheels axle (Lightest configuration) 07647 **148,00**

### Backrest adjustment and fixing system

- ☆ Backrest with double locking (upright and folded) **with rake adjustable from -4° to +16°**
- Backrest with upright locking system ONLY (no locking when folded) **with rake adjustable from -4° to +16°**
- Fixed back(non-folding back) **with rake adjustable from -4° to +16°**

### Backrest

☆ Adjustable velcro straps and padded transpiring upholstery

- ☆ Aluminium backrest
- Titanium backrest 06811 **189,00**
- Carbon fibre backrest 04389 **749,00**

- AIR** Integrated posture backrest (NOT REMOVABLE) **1.047,00**  
Carbon shell - Lateral retaining 7,5cm  
Depth adjustment ±1cm. - Angle adjustment ±10°  
not available for seat width 48

H 28		H 34		H 40	
Backrest Height (TS) min 34 ( ..... )		Backrest Height (TS) min 38 ( ..... )		Backrest Height (TS) min 44 ( ..... )	
Lateral retaining wing A=high - R=regular					
A	R	A	R	A	R
<input type="checkbox"/>	<input type="checkbox"/>	<input type="checkbox"/>	<input type="checkbox"/>	<input type="checkbox"/>	<input type="checkbox"/>

#### Installation on:

- ☆ Backrest tubes
- Aluminium backrest
- Titanium backrest 06811 **189,00**
- Carbon fibre backrest 04389 **749,00**

Date .....	Order .....	User .....	Address .....
------------	-------------	------------	---------------

<b>Handle tube</b>			
☆ Tubes with standard handle			
<input type="checkbox"/> Tubes with short handle			
<input type="checkbox"/> SPORT tubes Without push handles			
<input type="checkbox"/> Carbon fibre tubes with short handle	(Lightest configuration)	04390	148,00
<b>Not available with: Posture backrest PHYSIO - Posture backrest A I R</b>			
<input type="checkbox"/> Folding handles		02958	252,00











<b>Casters</b>			
☆ 4" Soft			
<input type="checkbox"/> 3" Sport (Lightest configuration)			
<input type="checkbox"/> 5" Soft			
<input type="checkbox"/> 6" Soft (Available only with 100° angle)			
<input type="checkbox"/> 6" Pneumatic (Available only with 100° angle)			
<input type="checkbox"/> 3" Active Soft (wide)	(Aluminium alloy rim)	06824	126,00
<input type="checkbox"/> 4" Active Sport (narrow)	(Aluminium alloy rim)	01398	126,00
<input type="checkbox"/> 4" Active Soft (wide)	(Aluminium alloy rim)	03943	126,00
<input type="checkbox"/> 5" Active Soft (wide)	(Aluminium alloy rim)	07518	126,00
<input type="checkbox"/> 5" Pneumatic		10844	63,00

<b>Colour set: Rear wheels and forks - To be matched only with: Rear wheels Ultra-light Progeo - Standard! (22 - 24)</b>			
☆ Black	22" 24" 25" 26"		
<input type="checkbox"/> Bright silver	22" 24"	00833	126,00
<input type="checkbox"/> Bright anthracite	24"	00833	126,00
<input type="checkbox"/> Bright orange	22" 24"	00833	126,00
<input type="checkbox"/> Bright fuchsia	22" 24"	00833	126,00
<input type="checkbox"/> Bright blue	22" 24"	00833	126,00
<input type="checkbox"/> Bright red	22" 24"	00833	126,00
<input type="checkbox"/> Bright lime	22" 24"	00833	126,00
<input type="checkbox"/> Pearl white	22" 24"	00833	126,00

<b>Rear wheels</b>			
☆ 24" Ultra-light Progeo - Standard!			
<input type="checkbox"/> 22" Ultra-light Progeo - Standard!			
<input type="checkbox"/> 25" Ultra-light Progeo - Standard! (colour: black)			
<input type="checkbox"/> 26" Progeo - Standard! (colour: black)			
<input type="checkbox"/> 24" ULTRA-LIGHT PROGEO KEY SPORT	Weight reduction approx. 450gr.	04383	876,00
<input type="checkbox"/> 24" Ultra-light "Spinergy LX"		01685	876,00
<input type="checkbox"/> 24" Ultra-light "Spinergy LXL"	<input type="checkbox"/> Black hub and white spokes <input type="checkbox"/> Hub and spokes black	07846	876,00
<input type="checkbox"/> 24" Ultra-light "Spinergy Flex rim"	Integrated aluminium/rubber handrim	02270	1.374,00
<input type="checkbox"/> 25" Ultra-light "Spinergy LX"		02101	876,00
<input type="checkbox"/> 25" Ultra-light "Spinergy LXL"	<input type="checkbox"/> Black hub and white spokes	07847	876,00
<input type="checkbox"/> 26" Ultra-light "Spinergy LX"		02102	876,00
<input type="checkbox"/> 24" Off-road (aluminium handrim black)		01392	224,00

<b>Rear wheel tyre</b>			
☆ High pressure tyre	(22"-24"-25"-26")	(Lightest configuration)	
<input type="checkbox"/> High pressure profile tyre	(24")		
<input type="checkbox"/> Marathon Plus	(24"-25")	with anti-puncture protection	01669 63,00
<input type="checkbox"/> Anti-puncture - Colour Grey	(22")		04181 98,00
<input type="checkbox"/> Anti-puncture - Colour Black	(24")		11083 126,00

<b>Handrim</b>		<b>Wheel distance ☆ 3 cm</b>	<input type="checkbox"/> 4 cm	
☆ Aluminium	(22"-24"-25"-26")	(Lightest configuration)		
<input type="checkbox"/> Aluminium black SOFT-TOUCH	(24"-25")	(24" handrim, on 25" wheel is installed with spacers)	09170	126,00
<input type="checkbox"/> Chromed Steel	(24"-25")	(24" handrim, on 25" wheel is installed with spacers)	01684	148,00
<input type="checkbox"/> Titanium	(24"-25")	(24" handrim, on 25" wheel is installed with spacers)	00016	275,00
<input type="checkbox"/> Ultra Grepp	(24"-25")	(24" handrim, on 25" wheel is installed with spacers)	00017	315,00
<input type="checkbox"/> Max Grepp	(24"-25")	(24" handrim, on 25" wheel is installed with spacers)	00834	349,00
<input type="checkbox"/> Ergo Para	(24")		00632	349,00
<input type="checkbox"/> TOP FRICTION	(24"-25")	(24" handrim, on 25" wheel is installed with spacers)	11023	399,00
Oval countour with a rubber insert				
<input type="checkbox"/> NOVA H	(24"-25")	(24" handrim, on 25" wheel is installed with spacers)	11025	263,00
Ergonomic black profile				
<input type="checkbox"/> NOVA D	(24"-25")	(24" handrim, on 25" wheel is installed with spacers)	11026	286,00
Ergonomic profile with rubber coating (ideal for quadriplegics)				
<input type="checkbox"/> SURGE LT	(25")	Oval countour with a rubber insert	06427	360,00
<input type="checkbox"/> Quad (24")	(24")		00693	200,00
<input type="checkbox"/> Silicon cover for standard aluminium handrim		Available for measures (22" - 24" - 26")	04050	160,00





Date .....	Order .....	User .....	Address .....
<b>Wheel locks</b>			
<input checked="" type="checkbox"/> Bent lever push to lock			
<input type="checkbox"/> Straight lever push to lock			
<input type="checkbox"/> Straight lever pull to lock			
<input type="checkbox"/> Sport brake <span style="float: right;">(Lightest configuration)</span>		 06428	126,00
<input type="checkbox"/> Brake with extension lever push to lock		 01949	63,00
<input type="checkbox"/> Brake with extension lever pull to lock		 03372	63,00
<b>Armrests</b>			
<input type="checkbox"/> Tubular armrests <span style="float: right;">(Swing away, removable and height adjustable armrest)</span>		 00694	252,00
<b>Accessories</b>			
<input type="checkbox"/> Pad for front frame protectors		07058	52,00
<input type="checkbox"/> Backrest-seat connection cloth		10241	17,00
<input type="checkbox"/> Removable storage bag (with quick coupling)		09811	126,00
<b>SAFETY</b>			
<input type="checkbox"/> 4 points tie-down system rings		 08654	189,00
<b>Optional 1</b>			
<u>Only one optional devices for side can be chosen</u>			
<input type="checkbox"/> Transit wheels <span style="float: right;">Exclude the installation of Anti-tippers</span>		 03290	148,00
<input type="checkbox"/> Anti-tipper BASE <span style="float: right;">Exclude the installation of Transit wheels</span>		<input type="radio"/> Right 06819	98,00
		<input type="radio"/> Left 06820	98,00
<input type="checkbox"/> Anti-tipper with rapid hookup <span style="float: right;">Exclude the installation of Transit wheels</span>		<input type="radio"/> Right 06821	126,00
(inside rotation to reduce the encumbrance)		<input type="radio"/> Left 06822	126,00
<b>Optional 2</b>			
<input type="checkbox"/> Push handles for companion <span style="float: right;">(Removable and height adjustable)</span>		 03645	177,00
<input type="checkbox"/> Tetraclip <span style="float: right;">(Quick release axle for quadriplegic)</span>		03947	177,00
<input type="checkbox"/> Safety pelvic belt		03972	63,00
<input type="checkbox"/> Harness		04103	126,00
<input type="checkbox"/> Lumbar support <span style="float: right;">(to insert in the backrest upholstery)</span>		00013	40,00
<input type="checkbox"/> Swing away lateral support <span style="float: right;">Not available with Posture backrest PHYSIO - Posture backrest A I R</span>		<input type="radio"/> Right 02097	252,00
		<input type="radio"/> Left 02098	252,00
<input type="checkbox"/> Spoke guards Black <span style="float: right;">(22"-24")</span>		01043	148,00
<input type="checkbox"/> Spoke guards Transparent <span style="float: right;">(22"-24")</span>		00835	148,00
<input type="checkbox"/> Spoke guards Progeo design <span style="float: right;">(22"-24")</span>		00019	177,00
<input type="checkbox"/> Spoke guards Dragon <span style="float: right;">(22"-24")</span>		02106	177,00
<b>Additional Kit</b>			
<input type="checkbox"/> 24" Off-road rear wheels <span style="float: right;">Off-Road tyre - aluminium handrim (black colour)</span>		03378	498,00
<input type="checkbox"/> 24" FAT rear wheels <span style="float: right;">FAT tyre 3" - aluminium handrim (black colour)</span>		09357	876,00

Date ..... Order ..... User ..... Address .....

### PHYSIO - Posture backrest (Std. Backrest upholstery not provided)





Removable with quick release  
Suitable for tubes with diameter 18±26mm  
Depth adjustment (4cm)  
Angle adjustment (±18°)

- AIR** Carbon shell  
not available for seat width 48

BACKREST HEIGHT	28	34	40	
Shell's shape  7.5 cm	Lateral retaining wing A=high - R=regular			
	A	R	A	R
				
	<input type="checkbox"/>	<input type="checkbox"/>	<input type="checkbox"/>	<input type="checkbox"/>

1.047,00

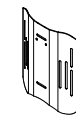
- POSTURE** Aluminum shell

BACKREST HEIGHT	34	40	52	
Shell's shape  7.5 cm	Lateral retaining wing B=regular			
	R	R	R	
				
	<input type="checkbox"/>	<input type="checkbox"/>	<input type="checkbox"/>	

1.013,00

### Configuration DEEP with side support PAD (height adjustable)

- Alluminum lateral with padded, breathable upholstery.



Small (h 13cm)



Right  
10272

29,00



Left  
10272

29,00

Large (h 20cm)



Right  
10273

40,00



Left  
10273

40,00

### SWING AWAY - Lateral support

Fixing and adjustment hardware complete with protection sleeve  
Alluminum lateral with padded, breathable upholstery.

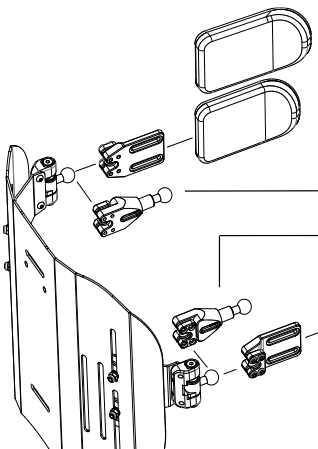

- Large (18x12)

05647 183,00

- Small (14x9)

05643 183,00

- Lateral support extension

Quantity (number pcs) (.....)

10271 69,00

- Lateral support extension

Quantity (number pcs) (.....)

- Small (14x9)

05642 183,00

- Large (18x12)

05646 183,00

- Headrest adjustable - Double ball mounting system

Available only with backrest Physio  
Not available for backrest Physio AIR carbon shell



- Large (34x14)  
 Small (28x14)

05648 252,00

Permobil Limited Unit 7, Polaris Centre, 41 Brownfields, Welwyn Garden City, Herts, AL7 1AN United Kingdom - Phone: +44 1484 722888



customer\_support\_uk@permobil.com - https://www.permobil.com/en-gb

Date .....	Order .....	User .....	Address .....
------------	-------------	------------	---------------

### Note

Wheelchair : Progeo JOKER - Rev. 2023.1	Prices - VAT excluded to be added to the price list	<table border="1" style="width: 100%; border-collapse: collapse;"> <tr> <td colspan="2" style="text-align: center; padding: 2px;"><b>Send this page only if any optional have been chosen</b></td> </tr> <tr> <td style="width: 10%; text-align: center; padding: 2px;"><input checked="" type="checkbox"/></td> <td style="padding: 2px;">standard <small>(supplied if no requests are indicated)</small></td> </tr> <tr> <td style="text-align: center; padding: 2px;"><input type="checkbox"/></td> <td style="padding: 2px;">on request <small>(without extra charge)</small></td> </tr> <tr> <td style="text-align: center; padding: 2px;"><input type="checkbox"/></td> <td style="padding: 2px;">optional <small>(cost to be added at the basic price)</small></td> </tr> </table>	<b>Send this page only if any optional have been chosen</b>		<input checked="" type="checkbox"/>	standard <small>(supplied if no requests are indicated)</small>	<input type="checkbox"/>	on request <small>(without extra charge)</small>	<input type="checkbox"/>	optional <small>(cost to be added at the basic price)</small>
<b>Send this page only if any optional have been chosen</b>										
<input checked="" type="checkbox"/>	standard <small>(supplied if no requests are indicated)</small>									
<input type="checkbox"/>	on request <small>(without extra charge)</small>									
<input type="checkbox"/>	optional <small>(cost to be added at the basic price)</small>									

### REFERENCE TABLES

1		Front height			
With closed frame (95°) max 5" caster					
With closed frame (90°) max 5" caster					
With closed frame (85°) max 4" caster					
FORK		Casters			
		3"	4"	5"	6"
SPORT		max 52	max 53	max 54	
SMALL		max 54	max 55	max 56	max 57
MEDIUM		max 56	max 57	max 58	max 59

The size of the fork will be defined only by Progeo in accordance with wheelchair final configuration.

2		Rear height			
Rear wheels					
		22"	24"	25"	26"
min	36	min 38	min 39	min 40	
max	44	max 46	max 47	max 48	

3	Footplate option	Footplate distance
	Aluminium footplate rake adjustable	min 35
	One piece Carbon fibre footplate	min 35
	One piece Carbon fibre footplate rake adjustable	min 35
	Plastic footrest, rake adjustable	min 35
	One piece aluminium footplate - Flip-up!, rake and depth adjustable	min 35
	One piece Carbon fibre footplate rake adjustable, swing away, flip-up.	min 35
<b>IMPORTANT NOTICE! From the footplate to the floor minimum 4cm !! (Minimum Front height = DP + 4cm.)</b>		
<b>Calculated with the best configuration and with the footplates positioned on inside.</b>		
<b>NOTE! Lower footplate distances are possible only after our valuation</b>		

4	Rear wheels	
	Model	Features
	22" Ultra-light Progeo - Standard!	(not available in anthracite color)
	24" Ultra-light Progeo - Standard!	(available for all colors)
	24" ULTRA-LIGHT PROGEO KEY SPORT	(silver hub, black rim and 16 spokes)
	24" Ultra-light "Spinergy LX"	(silver hub, black rim and spokes)
	24" Ultra-light "Spinergy LXL"	(black hub and rim, 18 white spokes) - (black hub, rim and 18 spokes)
	24" Ultra-light "Spinergy Flex rim"	(silver hub, black rim and spokes) - (integrated aluminium/rubber handrim - encumbrance reduction up to 3cm. - all tyre)
	24" Off-road	(colour: black) - (aluminium handrim - tyre Off-road)
	25" Ultra-light "Spinergy LX"	(silver hub, black rim and spokes)
	25" Ultra-light "Spinergy LXL"	(black hub and rim, 18 white spokes)
	26" Progeo - Standard!	(colour: black)
	26" Ultra-light "Spinergy LX"	(silver hub, black rim and 18 spokes)

Wheelchair : Progeo JOKER - Rev. 2023.1