











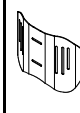

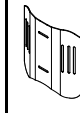



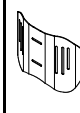

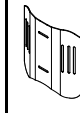



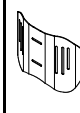

Date	Order	User	Address
------------	-------------	------------	---------------

Seat			
☆ Seat cloth with pocket (under seat)			
<input type="radio"/> Seat with tension straps		08883	224,00
<input type="radio"/> Carbon rigid seat		08336	475,00
<input type="radio"/> Pocket (under seat) [25x11x4,5]		08281	74,00

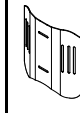
Backrest adjustment and fixing system			
<input checked="" type="checkbox"/> Backrest with double locking (upright and folded)		with rake adjustable from -4° to +16°	
<input type="checkbox"/> Backrest with upright locking system ONLY (no locking when folded)		with rake adjustable from -4° to +16°	
<input type="checkbox"/> Fixed back(non-folding back)		with rake adjustable from -4° to +16°	

Backrest																					
☆ Adjustable velcro straps and padded transpiring upholstery		☆ Aluminium backrest																			
		<input type="radio"/> Titanium backrest	06811 189,00																		
		<input type="radio"/> Carbon fibre backrest	04389 749,00																		
<input checked="" type="radio"/> AIR Integrated posture backrest (NOT REMOVABLE) 1.047,00 Carbon shell - Lateral retaining 7,5cm Depth adjustment ±1cm. - Angle adjustment ±10° not available for seat width 48																					
<table border="1" style="width: 100%; border-collapse: collapse; text-align: center;"> <tr> <td style="width: 33%;">H 28</td> <td style="width: 33%;">H 34</td> <td style="width: 33%;">H 40</td> </tr> <tr> <td>Backrest Height (TS) min 34</td> <td>Backrest Height (TS) min 38</td> <td>Backrest Height (TS) min 44</td> </tr> <tr> <td>(.....)</td> <td>(.....)</td> <td>(.....)</td> </tr> </table>			H 28	H 34	H 40	Backrest Height (TS) min 34	Backrest Height (TS) min 38	Backrest Height (TS) min 44	(.....)	(.....)	(.....)	Installation on: ☆ Backrest tubes <input type="checkbox"/> Aluminium backrest <input type="radio"/> Titanium backrest <input type="radio"/> Carbon fibre backrest									
H 28	H 34	H 40																			
Backrest Height (TS) min 34	Backrest Height (TS) min 38	Backrest Height (TS) min 44																			
(.....)	(.....)	(.....)																			
Lateral retaining wing A=high - R=regular <table border="1" style="width: 100%; border-collapse: collapse; text-align: center;"> <tr> <td>A</td><td>R</td><td>A</td><td>R</td><td>A</td><td>R</td> </tr> <tr> <td></td> <td></td> <td></td> <td></td> <td></td> <td></td> </tr> <tr> <td><input type="checkbox"/></td><td><input type="checkbox"/></td><td><input type="checkbox"/></td><td><input type="checkbox"/></td><td><input type="checkbox"/></td><td><input type="checkbox"/></td> </tr> </table>			A	R	A	R	A	R							<input type="checkbox"/>	<input type="checkbox"/>	<input type="checkbox"/>	<input type="checkbox"/>	<input type="checkbox"/>	<input type="checkbox"/>	   
A	R	A	R	A	R																
																					
<input type="checkbox"/>	<input type="checkbox"/>	<input type="checkbox"/>	<input type="checkbox"/>	<input type="checkbox"/>	<input type="checkbox"/>																

Handle tube			
☆ Tubes with short handle			
<input type="checkbox"/> SPORT tubes Without push handles			
<input type="radio"/> Carbon fibre tubes with short handle		(Lightest configuration)	04390 148,00
Not available with: Posture backrest PHYSIO - Posture backrest A I R			
<input type="radio"/> Folding handles			02958 252,00

Colour set: Rear wheels and forks - To be matched only with: Rear wheels Ultra-light Progeo - Standard! (22 - 24)			
☆ Black	22" 24" 25" 26"		
<input type="radio"/> Bright silver	22" 24"	00833	126,00
<input type="radio"/> Bright orange	22" 24"	00833	126,00
<input type="radio"/> Bright anthracite	24"	00833	126,00
<input type="radio"/> Bright fuchsia	22" 24"	00833	126,00
<input type="radio"/> Bright blue	22" 24"	00833	126,00
<input type="radio"/> Bright red	22" 24"	00833	126,00
<input type="radio"/> Bright lime	22" 24"	00833	126,00
<input type="radio"/> Pearl white	22" 24"	00833	126,00







Casters			
☆ 4" Soft			
<input type="checkbox"/> 3" Sport		(Lightest configuration)	
<input type="checkbox"/> 5" Soft		Not available with frame angle 90° to the floor	
<input type="radio"/> 3" Active Soft (wide) - Aluminium alloy rim		06824	126,00
<input type="radio"/> 4" Active Sport (narrow) - Aluminium alloy rim		01398	126,00
<input type="radio"/> 4" Active Soft (wide) - Aluminium alloy rim		03943	126,00
<input type="radio"/> 5" Active Soft (wide) - Aluminium alloy rim		Not available with frame angle 90° to the floor	
<input type="radio"/> 5" Pneumatic		Not available with frame angle 90° to the floor	
		10844	63,00

Date	Order	User	Address
------------	-------------	------------	---------------

Rear wheels			
<input checked="" type="checkbox"/> 24" Ultra-light Progeo - Standard!			
<input type="checkbox"/> 22" Ultra-light Progeo - Standard!			
<input type="checkbox"/> 25" Ultra-light Progeo - Standard!		(colour: black)	
<input type="checkbox"/> 26" Progeo - Standard!		(colour: black)	
<input type="checkbox"/> 24" ULTRA-LIGHT PROGEO KEY SPORT		(Lightest configuration)	04383 876,00
<input type="checkbox"/> 24" Ultra-light "Spinergy LX"			01685 876,00
<input type="checkbox"/> 24" Ultra-light "Spinergy LXL"	<input type="checkbox"/> Black hub and white spokes	<input type="checkbox"/> Hub and spokes black	07846 876,00
<input type="checkbox"/> 24" Ultra-light "Spinergy Flex rim"	Integrated aluminium/rubber handrim		02270 1.374,00
<input type="checkbox"/> 25" Ultra-light "Spinergy LX"			02101 876,00
<input type="checkbox"/> 25" Ultra-light "Spinergy LXL"	<input type="checkbox"/> Black hub and white spokes		07847 876,00
<input type="checkbox"/> 26" Ultra-light "Spinergy LX"			02102 876,00
<input type="checkbox"/> 24" Off-road (aluminium handrim black)			01392 224,00

Rear wheel tyre			
<input checked="" type="checkbox"/> High pressure tyre	(22"-24"-25"-26")	(Lightest configuration)	
<input type="checkbox"/> High pressure profile tyre	(24")		
<input type="checkbox"/> Marathon Plus	(24"-25")	with anti-puncture protection	01669 63,00
<input type="checkbox"/> Anti-puncture - Colour Grey	(22")		04181 98,00
<input type="checkbox"/> Anti-puncture - Colour Black	(24")		11083 126,00

Handrim	Wheel distance	★ 3 cm	□ 4 cm		
<input checked="" type="checkbox"/> Aluminium	(22"-24"-25"-26")		(Lightest configuration)		
<input type="checkbox"/> Aluminium black SOFT-TOUCH	(24"-25")		(24" handrim, on 25" wheel is installed with spacers)	09170	126,00
<input type="checkbox"/> Chromed Steel	(24"-25")		(24" handrim, on 25" wheel is installed with spacers)	01684	148,00
<input type="checkbox"/> Titanium	(24"-25")		(24" handrim, on 25" wheel is installed with spacers)	00016	275,00
<input type="checkbox"/> Ultra Grepp	(24"-25")		(24" handrim, on 25" wheel is installed with spacers)	00017	315,00
<input type="checkbox"/> Max Grepp	(24"-25")		(24" handrim, on 25" wheel is installed with spacers)	00834	349,00
<input type="checkbox"/> Ergo Para	(24")			00632	349,00
<input type="checkbox"/> TOP FRICTION	(24"-25")		(24" handrim, on 25" wheel is installed with spacers)	11023	399,00
<input type="checkbox"/> Oval countour with a rubber insert					
<input type="checkbox"/> NOVA H	(24"-25")		(24" handrim, on 25" wheel is installed with spacers)	11025	263,00
<input type="checkbox"/> Ergonomic black profile					
<input type="checkbox"/> NOVA D	(24"-25")		(24" handrim, on 25" wheel is installed with spacers)	11026	286,00
<input type="checkbox"/> Ergonomic profile with rubber coating (ideal for quadriplegics)					
<input type="checkbox"/> SURGE LT	(25")		Oval countour with a rubber insert	06427	360,00
<input type="checkbox"/> Quad	(24")			00693	200,00
<input type="checkbox"/> Silicon cover for standard aluminium handrim			Available for measures (22" - 24" - 26")	04050	160,00





Wheel locks			
<input checked="" type="checkbox"/> Bent lever push to lock			
<input type="checkbox"/> Straight lever push to lock			
<input type="checkbox"/> Straight lever pull to lock			
<input type="checkbox"/> Sport brake		(Lightest configuration)	
<input type="checkbox"/> Brake with extension lever push to lock			
<input type="checkbox"/> Brake with extension lever pull to lock			



Mudguard			
<input checked="" type="checkbox"/> Carbon fibre mudguard			
<input type="checkbox"/> Carbon fibre Straight sideguard	<input checked="" type="checkbox"/> ★ Aligned wheel	<input type="checkbox"/> Under wheel cm	<input type="checkbox"/> Above wheel cm
<input type="checkbox"/> Removable carbon fibre mudguard			04109 252,00
<input type="checkbox"/> Removable Carbon fibre straight sideguard	<input checked="" type="checkbox"/> ★ Aligned wheel	<input type="checkbox"/> Under wheel cm	<input type="checkbox"/> Above wheel cm
<input type="checkbox"/> Welded straight mudguard	Available only with made-to-measure welded frame and fixed and welded backrest		08933 372,00
	<input checked="" type="checkbox"/> ★ Aligned wheel	<input type="checkbox"/> Under wheel cm	<input type="checkbox"/> Above wheel cm

Date	Order	User	Address
------------	-------------	------------	---------------

Armrests			
<input type="checkbox"/> Tubular armrests	(Swing away, removable and height adjustable armrest)		00694 252,00

Accessories			
<input type="checkbox"/> Pad for front frame protectors			07058 52,00
<input type="checkbox"/> Backrest-seat connection cloth			10241 17,00
<input type="checkbox"/> Removable storage bag (with quick coupling)			09811 126,00

Optional 1			
<input type="checkbox"/> Set-up for post-sale optional assembly			
<input type="checkbox"/> Transit wheels			03290 148,00
<input type="checkbox"/> Crutches support	<input type="radio"/> Right <input type="radio"/> Left		00838 74,00 00837 74,00
<input type="checkbox"/> Anti-tipper with rapid hookup	(inside rotation to reduce the encumbrance) <input type="radio"/> Right <input type="radio"/> Left		06821 126,00 06822 126,00
<input type="checkbox"/> Tipping aid	<input type="radio"/> Right <input type="radio"/> Left		00025 74,00 01046 74,00

Optional 2			
<input type="checkbox"/> Push handles for companion	(Removable and height adjustable)		03645 177,00
<input type="checkbox"/> Tetracrip	(Quick release axle for quadriplegic)		03947 177,00
<input type="checkbox"/> Safety pelvic belt			03972 63,00
<input type="checkbox"/> Harness			04103 126,00
<input type="checkbox"/> Lumbar support	(to insert in the backrest upholstery)		00013 40,00
<input type="checkbox"/> Swing away lateral support	<input type="radio"/> Right <input type="radio"/> Left		02097 252,00 02098 252,00
Not available with: Posture backrest PHYSIO - Posture backrest A I R			
<input type="checkbox"/> Spoke guards Black	(22"-24")		01043 148,00
<input type="checkbox"/> Spoke guards Transparent	(22"-24")		00835 148,00
<input type="checkbox"/> Spoke guards Progeo design	(22"-24")		00019 177,00
<input type="checkbox"/> Spoke guards Dragon	(22"-24")		02106 177,00

Additional Kit			
<input type="checkbox"/> 24" Off-road rear wheels	Off-Road tyre - aluminium handrim (black colour)		03378 498,00
<input type="checkbox"/> 24" FAT rear wheels	FAT tyre 3" - aluminium handrim (black colour)		09357 876,00

Permobil Limited Unit 7, Polaris Centre, 41 Brownfields, Welwyn Garden City, Herts, AL7 1AN United Kingdom - Phone: +44 1484 722888

customer_support_uk@permobil.com - https://www.permobil.com/en-gb

Date Order User Address

PHYSIO - Posture backrest
(Std. Backrest upholstery not provided)

Removable with quick release
 Suitable for tubes with diameter 18÷26mm
 Depth adjustment (4cm)
 Angle adjustment (±18°)

- AIR** Carbon shell
 not available for seat width 48

BACKREST HEIGHT	28	34	40
Shell's shape 	Lateral retaining wing A=high - R=regular		
	A	R	A
	<input type="checkbox"/>	<input type="checkbox"/>	<input type="checkbox"/>

1.047,00

- POSTURE** Aluminum shell

BACKREST HEIGHT	34	40	52
Shell's shape 	Lateral retaining wing B=regular		
	R	R	R
	<input type="checkbox"/>	<input type="checkbox"/>	<input type="checkbox"/>

1.013,00

Configuration DEEP with side support PAD (height adjustable)

- Alluminum lateral with padded, breathable upholstery.



Small (h 13cm)



Right
10272

29,00



Left
10272

29,00

Large (h 20cm)



Right
10273

40,00



Left
10273

40,00

SWING AWAY - Lateral support

Fixing and adjustment hardware complete with protection sleeve
 Alluminum lateral with padded, breathable upholstery.

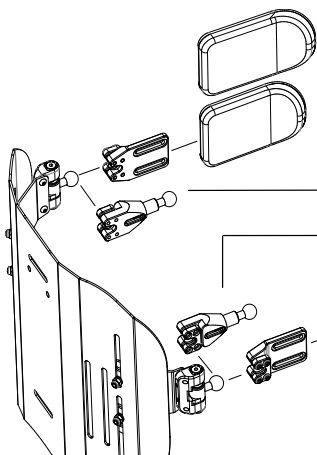

- Large (18x12)

05647 183,00

- Small (14x9)

05643 183,00

- Lateral support extension

Quantity (number pcs)..... 10271 69,00

- Lateral support extension

Quantity (number pcs).....

- Small (14x9)

05642 183,00

- Large (18x12)

05646 183,00

- Headrest adjustable - Double ball mounting system

Available only with backrest Physio
 Not available for backrest Physio AIR carbon shell



- Large (34x14) 05648 252,00
- Small (28x14)

Permobil Limited Unit 7, Polaris Centre, 41 Brownfields, Welwyn Garden City, Herts, AL7 1AN United Kingdom - Phone: +44 1484 722888

customer_support_uk@permobil.com - https://www.permobil.com/en-gb

Date	Order	User	Address
------------	-------------	------------	---------------

1	A Footplate width			
	DP	35+39	40+45	46+50
LS				
33	21	20	19	
36	24	23	22	
39	26	25	24	
42	29	28	27	
45	32	31	30	
48	35	34	33	

2	Setting	C :
	Extremely prudential	7,5
	Prudential	9
	Standard	10,5
	Active	12
	Extreme	13,5

3	Lt Maximum width
Camber	
0°	LS + 18
2°	LS + 21
4°	LS + 24
8°	LS + 30
12°	LS + 36

Maximum width calculated including 3 cm. distance between tyre and handrim

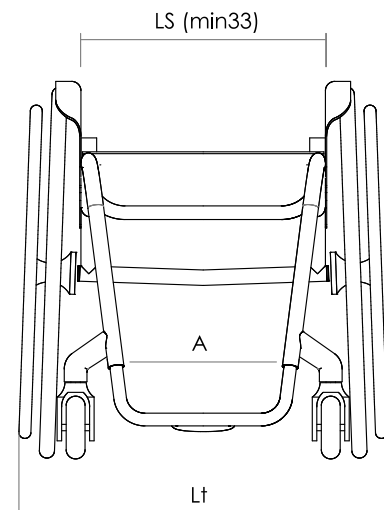
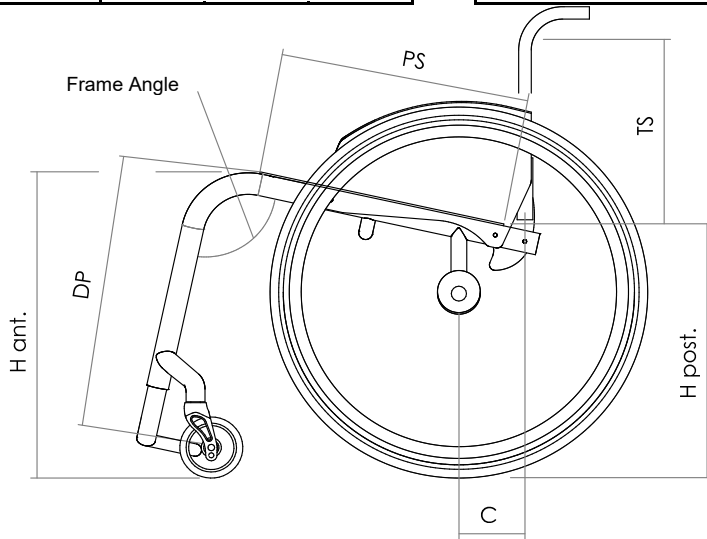

Wheelchair : Progeo JOKER ENERGY - Rev. 2023.1

Prices - VAT excluded
to be added to the price list

Send this page only if any optional have been chosen	
<input checked="" type="checkbox"/>	☆ standard (supplied if no requests are indicated)
<input type="checkbox"/>	□ on request (without extra charge)
<input type="checkbox"/>	○ optional (cost to be added at the basic price)