

| | | |
|----------------------------|-------------------|--|
| Date | UK (English) | |
| User | Company stamp | Rigid frame wheelchair |
| End user weight (kg) | | £ 3205,00 |
| Language user manual | Responsible | Retail price - VAT not included |

| Wheelchair measures | | | | | | |
|---|--|-------------------------------------|---------------------------------|----------------------------------|-----------------------------|---|
| Seat width (LS) | <input type="checkbox"/> 33 | <input type="checkbox"/> 36 | <input type="checkbox"/> 39 | <input type="checkbox"/> 42 | <input type="checkbox"/> 45 | <input type="checkbox"/> 48 |
| <small>The seat width is measured from the outer sides of the frame, while the distance between the two side guards is 1.5 cm wider.</small> | | | | | | |
| Seat depth (PS) | <input type="checkbox"/> 35 | <input type="checkbox"/> 37,5 | <input type="checkbox"/> 40 | <input type="checkbox"/> 42,5 | <input type="checkbox"/> 45 | <input type="checkbox"/> 47,5 <input type="checkbox"/> 50 |
| <small>The real seat depth, from the front part of the seat cloth to the backrest tube will be 1,5 cm more than the declared one.</small> | | | | | | |
| Footplate distance (DP) | (cm) ±0.5cm - adjustment steps 1.5cm | | | | | |
| <small>(Real distance between seat and footplate) - IMPORTANT NOTICE! From the footplate to the floor minimum 4cm !! (Minimum Front height = DP + 4cm.)</small> | | | | | | |
| Setting | <input checked="" type="checkbox"/> Standard | <input type="checkbox"/> Prudential | <input type="checkbox"/> Active | <input type="checkbox"/> Extreme | | |
| Backrest Height (TS) | Std.Value 33,5(min 24.5-max 47) adjustment steps 1.5cm | | | | | |
| Camber | <input checked="" type="checkbox"/> 0° | <input type="checkbox"/> 2° | <input type="checkbox"/> 4° | | | |

★ Standard rear adjustment

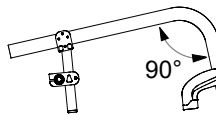

- ★ Carbon fibre mudguard
- Carbon fibre Straight sideguard
- Removable version



08921 **126,00**

FULL CARBON rear adjustment plate with integrated mudguard (Lightest configuration)

07646 **939,00**

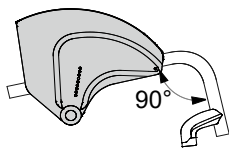

- ★ Version mudguard (AVAILABLE ONLY WITH REAR WHEELS 24")
- Version straight sideguard

Front height - Tick the box with the required height

The possible difference in height between HIGH frame and LOW frame is 3cm (with same fork, caster and assembly hole).

| | SPORT fork (H95) | Small size fork (H115) |
|---|---|---|
| LOW FRAME 90° Front height (min 44,5 - max 50) Footplate distance (min 33) <div style="border: 1px solid black; padding: 2px; margin-top: 5px;"> <i>U-TUBE Aluminium footplate</i> Footplate distance (min 18 + max 35) DPmax = Front height - 10cm </div> | Casters 3" <input type="checkbox"/> ~45 <input type="checkbox"/> ~46 4" <input type="checkbox"/> ~46 <input type="checkbox"/> ~47 5" <input type="checkbox"/> ~48,5 | Casters 3" <input type="checkbox"/> ~45,5 <input type="checkbox"/> ~47 4" <input type="checkbox"/> ~46,5 <input type="checkbox"/> ~48 <input type="checkbox"/> ~49 5" <input type="checkbox"/> ~49 <input type="checkbox"/> ~50 |
| HIGH FRAME 90° Front height (min 47,5 - max 53) Footplate distance (min 36) <div style="border: 1px solid black; padding: 2px; margin-top: 5px;"> <i>U-TUBE Aluminium footplate</i> Footplate distance (min 21 + max 38) DPmax = Front height - 10cm </div> | Casters 3" <input type="checkbox"/> ~48 <input type="checkbox"/> ~49 4" <input type="checkbox"/> ~49 <input type="checkbox"/> ~50 5" <input type="checkbox"/> ~51,5 | Casters 3" <input type="checkbox"/> ~48,5 <input type="checkbox"/> ~50 4" <input type="checkbox"/> ~49,5 <input type="checkbox"/> ~51 <input type="checkbox"/> ~52 5" <input type="checkbox"/> ~52 <input type="checkbox"/> ~53 |

The real front-seat height could be slightly different from the chosen one considering it is affected by seat depth and rear seat height.

Rear height

- Rear wheels 22" (min 36 - max 44)
- Rear wheels 24" (min 38 - max 46)
- Rear wheels 25" (min 39 - max 47)
- Rear wheels 26" (min 41 - max 48)

The difference between Front Height and Rear Height must be in the 3 - 12 cm range.

Permobil Limited Unit 7, Polaris Centre, 41 Brownfields, Welwyn Garden City, Herts, AL7 1AN United Kingdom - Phone: +44 1464 722888

customer_support_uk@permobil.com - https://www.permobil.com/en-gb

Date Order User Address

Seat

☆ Seat cloth with pocket (under seat)

Seat with tension straps 08883 **224,00**

Carbon rigid seat 08336 **475,00**

Pocket (under seat) [25x11x4,5] 08281 **74,00**

CUSTOMIZE COLORS

1 Frame colour

Pearl white Opaque orange

Opaque black 08341 **63,00**

Bright silver

Bright red

Bright blue

2 Fork colour

☆ Opaque black

Bright silver Bright blue

Bright anthracite Bright orange

Pearl white Bright fuchsia

Bright red Bright lime

08342 **63,00**

3 Colour rear wheels

To be matched only with: Rear wheels Ultra-light Progeo - Standard! (22 - 24)

☆ Black

Bright silver Bright orange

Bright anthracite (24") Bright blue

Pearl white Bright fuchsia

Bright red Bright lime

04692 **63,00**

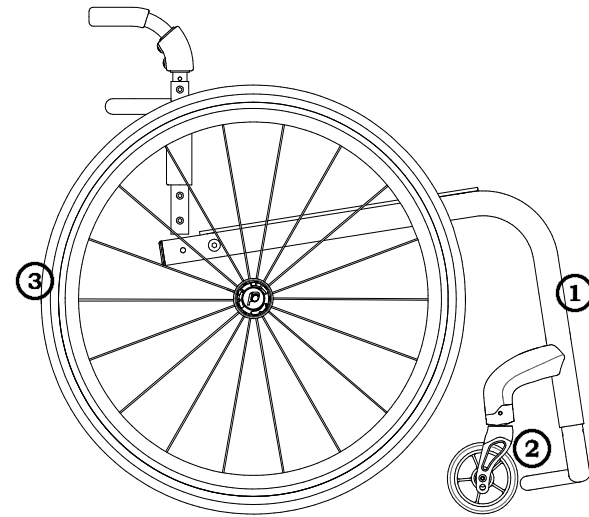

Rear wheels axle

☆ Aluminum rear wheels axle

Carbon fiber rear wheels axle (Lightest configuration) **07647 148,00**

Backrest adjustment and fixing system

☆ Backrest with double locking (upright and folded) with rake adjustable from -4° to +16°

Backrest with upright locking system ONLY (no locking when folded) with rake adjustable from -4° to +16°

Fixed back(non-folding back) with rake adjustable from -4° to +16°

Backrest

☆ Adjustable velcro straps and padded transpiring upholstery

Aluminium backrest

Titanium backrest 06811 **189,00**

Carbon fibre backrest 04389 **749,00**

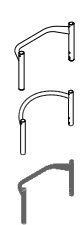

AIR **Integrated posture backrest (NOT REMOVABLE)** **1.047,00**

Carbon shell - Lateral retaining 7,5cm
Depth adjustment ±1cm. - Angle adjustment ±10°
not available for seat width 48

| H 28 | H 34 | H 40 |
|--------------------------------|--------------------------------|--------------------------------|
| Backrest Height (TS) min 34 | Backrest Height (TS) min 38 | Backrest Height (TS) min 44 |
| (.....) | (.....) | (.....) |

Lateral retaining wing A=high - R=regular

| A | R | A | R | A | R |
|--------------------------|--------------------------|--------------------------|--------------------------|--------------------------|--------------------------|
| | | | | | |
| <input type="checkbox"/> | <input type="checkbox"/> | <input type="checkbox"/> | <input type="checkbox"/> | <input type="checkbox"/> | <input type="checkbox"/> |

Installation on:

☆ Backrest tubes

Aluminium backrest

Titanium backrest 06811 **189,00**

Carbon fibre backrest 04389 **749,00**

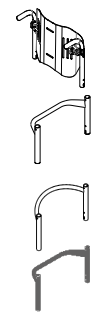

| | | | |
|------------|-------------|------------|---------------|
| Date | Order | User | Address |
|------------|-------------|------------|---------------|

| | | | |
|---|---------------------------------|-------|--------|
| Handle tube | | | |
| ☆ Tubes with standard handle | | | |
| <input type="checkbox"/> Tubes with short handle | | | |
| <input type="checkbox"/> SPORT tubes Without push handles | | | |
| <input type="radio"/> Carbon fibre tubes with short handle | Weight reduction approx. 110gr. | 04390 | 148,00 |
| Not available with: Posture backrest PHYSIO - Posture backrest A I R | | | |
| <input type="radio"/> Folding handles | | 02958 | 252,00 |



| | | | |
|--|-----------------------|-------|--------|
| Casters | | | |
| ☆ 4" Soft | | | |
| <input type="checkbox"/> 3" Sport | | | |
| <input type="checkbox"/> 5" Soft | | | |
| <input type="radio"/> 3" Active Soft (wide) | (Aluminium alloy rim) | 06824 | 126,00 |
| <input type="radio"/> 4" Active Sport (narrow) | (Aluminium alloy rim) | 01398 | 126,00 |
| <input type="radio"/> 4" Active Soft (wide) | (Aluminium alloy rim) | 03943 | 126,00 |
| <input type="radio"/> 5" Active Soft (wide) | (Aluminium alloy rim) | 07518 | 126,00 |
| <input type="radio"/> 5" Pneumatic | | 10844 | 63,00 |

| | | | |
|--|---|-------|----------|
| Rear wheels | | | |
| ☆ 24" Ultra-light Progeo - Standard! | | | |
| <input type="checkbox"/> 22" Ultra-light Progeo - Standard! | | | |
| <input type="checkbox"/> 25" Ultra-light Progeo - Standard! | (colour: black) | | |
| <input type="checkbox"/> 26" Progeo - Standard! | (colour: black) | | |
| <input type="radio"/> 24" ULTRA-LIGHT PROGEO KEY SPORT | Weight reduction approx. 450gr. | 04383 | 876,00 |
| <input type="radio"/> 24" Ultra-light "Spinergy LX" | | 01685 | 876,00 |
| <input type="radio"/> 24" Ultra-light "Spinergy LXL" | <input type="checkbox"/> Black hub and white spokes <input type="checkbox"/> Hub and spokes black | 07846 | 876,00 |
| <input type="radio"/> 24" Ultra-light "Spinergy Flex rim" | Integrated aluminium/rubber handrim | 02270 | 1.374,00 |
| <input type="radio"/> 25" Ultra-light "Spinergy LX" | | 02101 | 876,00 |
| <input type="radio"/> 25" Ultra-light "Spinergy LXL" | <input type="checkbox"/> Black hub and white spokes | 07847 | 876,00 |
| <input type="radio"/> 26" Ultra-light "Spinergy LX" | | 02102 | 876,00 |
| <input type="radio"/> 24" Off-road (aluminium handrim black) | | 01392 | 224,00 |

| | | | |
|---|-------------------|-------------------------------|--------------|
| Rear wheel tyre | | | |
| ☆ High pressure tyre | (22"-24"-25"-26") | | |
| <input type="checkbox"/> High pressure profile tyre | (24") | | |
| <input type="radio"/> Marathon Plus | (24"-25") | with anti-puncture protection | 01669 63,00 |
| <input type="radio"/> Anti-puncture - Colour Grey | (22") | | 04181 98,00 |
| <input type="radio"/> Anti-puncture - Colour Black | (24") | | 11083 126,00 |

| | | | |
|--|-------------------|---|--------------|
| Handrim | | | |
| | | Wheel distance ☆ 3 cm <input type="checkbox"/> 4 cm | |
| ☆ Aluminium | (22"-24"-25"-26") | | |
| <input type="radio"/> Aluminium black SOFT-TOUCH | (24"-25") | (24" handrim, on 25" wheel is installed with spacers) | 09170 126,00 |
| <input type="radio"/> Chromed Steel | (24"-25") | (24" handrim, on 25" wheel is installed with spacers) | 01684 148,00 |
| <input type="radio"/> Titanium | (24"-25") | (24" handrim, on 25" wheel is installed with spacers) | 00016 275,00 |
| <input type="radio"/> Ultra Grepp | (24"-25") | (24" handrim, on 25" wheel is installed with spacers) | 00017 315,00 |
| <input type="radio"/> Max Grepp | (24"-25") | (24" handrim, on 25" wheel is installed with spacers) | 00834 349,00 |
| <input type="radio"/> Ergo Para | (24") | | 00632 349,00 |
| <input type="radio"/> TOP FRICTION | (24"-25") | (24" handrim, on 25" wheel is installed with spacers) | 11023 399,00 |
| Oval countour with a rubber insert | | | |
| <input type="radio"/> NOVA H | (24"-25") | (24" handrim, on 25" wheel is installed with spacers) | 11025 263,00 |
| Ergonomic black profile | | | |
| <input type="radio"/> NOVA D | (24"-25") | (24" handrim, on 25" wheel is installed with spacers) | 11026 286,00 |
| Ergonomic profile with rubber coating (ideal for quadriplegics) | | | |
| <input type="radio"/> SURGE LT | (25") | Oval countour with a rubber insert | 06427 360,00 |
| <input type="radio"/> Quad (24") | (24") | | 00693 200,00 |
| <input type="radio"/> Silicon cover for standard aluminium handrim | | Available for measures (22" - 24" - 26") | 04050 160,00 |

| | | | |
|---|--|--|--|
| Wheel locks | | | |
| ☆ Bent lever push to lock | | | |
| <input type="checkbox"/> Straight lever push to lock | | | |
| <input type="checkbox"/> Straight lever pull to lock | | | |
| <input type="radio"/> Sport brake | | | |
| <input type="radio"/> Brake with extension lever push to lock | | | |
| <input type="radio"/> Brake with extension lever pull to lock | | | |



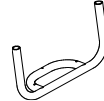

| | | | |
|------------|-------------|------------|---------------|
| Date | Order | User | Address |
|------------|-------------|------------|---------------|

| Footplate | | | |
|---|---|---|--|
| ☆ Aluminium footplate. Rake not adjustable | | | |
| <input type="checkbox"/> Aluminium footplate | <input type="checkbox"/> with plastic plate |  | |
| ○ One piece aluminium footplate - Flip-up! FLIP-BACK! - rake and depth adjustable | | | |
| 09420 189,00 | | | |
| ○ Aluminium footplate - rake and depth adjustable | | | |
| 04456 252,00 | | | |
| ☆ Internal <input type="checkbox"/> 2/3 Internal <input type="checkbox"/> External <input type="checkbox"/> 2/3 External | | | |
| ○ U-TUBE - Aluminium footplate, rake and depth adjustable | | | |
| LOW FRAME: minimum footplate distance 18 - maximum footplate distance 35 HIGH FRAME: minimum footplate distance 21 - maximum footplate distance 38 | | | |
| ○ One piece Carbon fibre footplate. Rake adjustable | | | |
| 04110 372,00 | | | |
| ☆ Internal <input type="checkbox"/> External | | | |

| Armrests | | | |
|--|--|--|--|
| ○ Tubular armrests | | | |
| (Swing away, removable and height adjustable armrest) | | | |
| 00694 252,00 | | | |
| ○ Removable armrest with carbon-fiber straight sideguard | | | |
| Available only with: Standard rear adjustment | | | |
| 09079 224,00 | | | |

| Accessories | | | |
|---|--|--|--|
| ○ Pad for front frame protectors | | | |
| 07058 52,00 | | | |
| ○ Backrest-seat connection cloth | | | |
| 10241 17,00 | | | |
| ○ Removable storage bag (with quick coupling) | | | |
| 09811 126,00 | | | |

| Optional 1 | | | |
|--|--|--|--|
| <u>Only one optional devices for side can be chosen</u> | | | |
| ○ Transit wheels | | | |
| Exclude the installation of Anti-tippers | | | |
| 03290 148,00 | | | |
| ○ Anti-tipper with rapid hookup | | | |
| Exclude the installation of Transit wheels (inside rotation to reduce the encumbrance) | | | |
| <input type="checkbox"/> Right | | | |
| 06821 126,00 | | | |
| <input type="checkbox"/> Left | | | |
| 06822 126,00 | | | |

| Optional 2 | | | |
|--|--|--|--|
| ○ Push handles for companion | | | |
| (Removable and height adjustable) | | | |
| 03645 177,00 | | | |
| ○ Tetracclip | | | |
| (Quick release axle for quadriplegic) | | | |
| 03947 177,00 | | | |
| ○ Safety pelvic belt | | | |
| 03972 63,00 | | | |
| ○ Harness | | | |
| 04103 126,00 | | | |
| ○ Lumbar support | | | |
| (to insert in the backrest upholstery) | | | |
| 00013 40,00 | | | |
| ○ Swing away lateral support | | | |
| Not available with: | | | |
| Posture backrest PHYSIO - Posture backrest A I R | | | |
| <input type="checkbox"/> Right <input type="checkbox"/> Left | | | |
| 02097 252,00 | | | |
| 02098 252,00 | | | |
| ○ Spoke guards Black | | | |
| (22"-24") | | | |
| 01043 148,00 | | | |
| ○ Spoke guards Transparent | | | |
| (22"-24") | | | |
| 00835 148,00 | | | |
| ○ Spoke guards Progeo design | | | |
| (22"-24") | | | |
| 00019 177,00 | | | |
| ○ Spoke guards Dragon | | | |
| (22"-24") | | | |
| 02106 177,00 | | | |

| Additional Kit | | | |
|--|--|--|--|
| ○ 24" Off-road rear wheels | | | |
| Off-Road tyre - aluminium handrim (black colour) | | | |
| 03378 498,00 | | | |
| ○ 24" FAT rear wheels | | | |
| FAT tyre 3" - aluminium handrim (black colour) | | | |
| 09357 876,00 | | | |

Date Order User Address

PHYSIO - Posture backrest (Std. Backrest upholstery not provided)

Removable with quick release
Suitable for tubes with diameter 18±26mm
Depth adjustment (4cm)
Angle adjustment (±18°)

- AIR** Carbon shell
not available for seat width 48

| BACKREST HEIGHT | 28 | 34 | 40 | |
|--|---|------------------------------|------------------------------|------------------------------|
| Shell's shape  7.5 cm | Lateral retaining wing A=high - R=regular | | | |
| | <input type="checkbox"/> | <input type="checkbox"/> | <input type="checkbox"/> | <input type="checkbox"/> |

1.047,00

- POSTURE** Aluminum shell

| BACKREST HEIGHT | 34 | 40 | 52 | |
|--|----------------------------------|------------------------------|------------------------------|--|
| Shell's shape  7.5 cm | Lateral retaining wing B=regular | | | |
| | <input type="checkbox"/> | <input type="checkbox"/> | <input type="checkbox"/> | |

1.013,00

Configuration DEEP with side support PAD (height adjustable)

- Aluminum lateral with padded, breathable upholstery.



Small (h 13cm)



Right
10272

29,00



Left
10272

29,00

Large (h 20cm)



Right
10273

40,00



Left
10273

40,00

SWING AWAY - Lateral support

Fixing and adjustment hardware complete with protection sleeve
Aluminum lateral with padded, breathable upholstery.

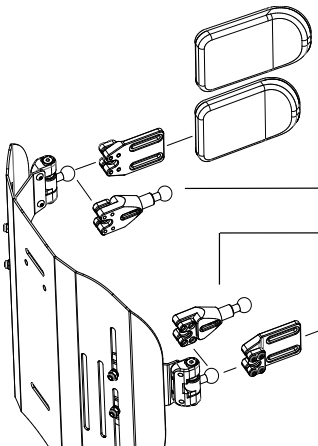

- Large (18x12)

05647 183,00

- Small (14x9)

05643 183,00

- Lateral support extension

Quantity (number pcs).....

- Lateral support extension

Quantity (number pcs).....

- Small (14x9)

05642 183,00

- Large (18x12)

05646 183,00

- Headrest adjustable - Double ball mounting system

Available only with backrest Physio
Not available for backrest Physio AIR carbon shell



- Large (34x14)
- Small (28x14)

05648 252,00

| | | | |
|------------|-------------|------------|---------------|
| Date | Order | User | Address |
|------------|-------------|------------|---------------|

Note

| | | | | | | | | | | |
|--|--|--|--|--|---|--|---|---|---|--|
| Wheelchair : Progeo JOKER R2 - Rev. 2023.2 | Prices - VAT excluded to be added to the price list | <table border="1" style="width: 100%; border-collapse: collapse;"> <tr> <td colspan="2" style="text-align: center; font-weight: bold; font-size: small;">Send this page only if any optional have been chosen</td> </tr> <tr> <td style="width: 10%; text-align: center;">★</td> <td style="font-size: x-small;"> standard <small>(supplied if no requests are indicated)</small> </td> </tr> <tr> <td style="text-align: center;">□</td> <td style="font-size: x-small;"> on request <small>(without extra charge)</small> </td> </tr> <tr> <td style="text-align: center;">○</td> <td style="font-size: x-small;"> optional <small>(cost to be added at the basic price)</small> </td> </tr> </table> | Send this page only if any optional have been chosen | | ★ | standard <small>(supplied if no requests are indicated)</small> | □ | on request <small>(without extra charge)</small> | ○ | optional <small>(cost to be added at the basic price)</small> |
| Send this page only if any optional have been chosen | | | | | | | | | | |
| ★ | standard <small>(supplied if no requests are indicated)</small> | | | | | | | | | |
| □ | on request <small>(without extra charge)</small> | | | | | | | | | |
| ○ | optional <small>(cost to be added at the basic price)</small> | | | | | | | | | |