

# permobil Order Form - Progeo noir 2.0

Permobil Limited Unit 7, Polaris Centre, 41 Brownfields, Welwyn Garden City, Herts, AL7 1AN United Kingdom - Phone: +44 1484 722888

Date .....	UK (English)	
User .....	Company stamp	Rigid frame wheelchair
End user weight (kg) .....		<b>£ 8071,00</b>
Language user manual .....	Responsible .....	<b>Retail price - VAT not included</b>

**Carbon fibre frame made-to-measure.**

**NOIR is a wheelchair without possibilities of adjustments after its manufacturing..**

See reference tables

Take care to write all the requested measures (in centimetres)

**Seat depth (PS)**

<input type="checkbox"/> 35	<input type="checkbox"/> 37,5
<input type="checkbox"/> 40	<input type="checkbox"/> 42,5
<input type="checkbox"/> 45	<input type="checkbox"/> 47,5

**Frame Angle**

85°  90°  95°

**See note ( 1 )**

Backrest rake adjustable from -4° to +16°

**Seat width (LS)**

<input type="checkbox"/> 33	<input type="checkbox"/> 36
<input type="checkbox"/> 39	<input type="checkbox"/> 42
<input type="checkbox"/> 45	

**Setting C**

<input type="checkbox"/> Extremely prudential 7,5
<input type="checkbox"/> Prudential 9
<input checked="" type="checkbox"/> Standard 10,5
<input type="checkbox"/> Active 12
<input type="checkbox"/> Extreme 13,5

**camber**

2°  0°  4°

**Front height (min 44-max 54)**

**Rear height (min 37-max 48)**  
calculated with rear wheels 24"

customer\_support\_uk@permobil.com - https://www.permobil.com/en-gb

**Footplate option**

Carbon fibre frame with integrated footplate, not adjustable  
**(Lightest configuration)**

Aluminium footplate adjustable distance +/- 1,5cm (rake and depth adjustable)  
**Minimum footplate distance 35cm.**

Internal   
  2/3 Internal   
  2/3 External   
  External

11531    **no list**

**Seat**

Seat cloth with pocket (under seat)

Seat with tension straps 08883    **224,00**

Carbon rigid seat 08336    **475,00**

Pocket (under seat) [25x11x4,5] 08281    **74,00**

Date ..... Order ..... User ..... Address .....

*Since that the paint is sensitive to the surface material and texture, the colour selected for the wheelchair frame can also differ considerably from what is displayed on a RAL colour chart or also compared to what is displayed on a monitor.*

### CARBON



- ☆ Polished transparent painting  Opaque transparent painting 08925 **624,00**

### ESSENCE

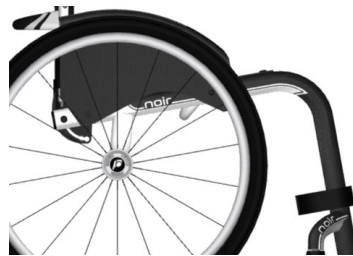

#### Polished transparent painting

- ANTHRACITE Essence 10351 **876,00**
- BLUE Essence 08928 **876,00**
- GREEN Essence 11163 **876,00**
- LIME Essence 08926 **876,00**
- ORANGE Essence 10349 **876,00**
- RED Essence 08927 **876,00**
- SAND Essence 11165 **876,00**
- VIOLET Essence 11167 **876,00**
- WHITE Essence 10350 **876,00**

#### Opaque transparent painting

- ANTHRACITE Opaque Essence 08929 **1.121,00**
- BLUE Opaque Essence 10354 **1.121,00**
- GREEN Opaque Essence 11162 **1.121,00**
- LIME Opaque Essence 10352 **1.121,00**
- ORANGE Opaque Essence 10355 **1.121,00**
- RED Opaque Essence 10353 **1.121,00**
- SAND Opaque Essence 11164 **1.121,00**
- VIOLET Opaque Essence 11166 **1.121,00**
- WHITE Opaque Essence 10356 **1.121,00**

- my ESSENCE colour RAL \_\_\_\_\_  Glossy Note 11186 **1.293,00**
- Opaque

### RACE



#### Polished transparent painting

- ANTHRACITE Race 11168 **876,00**
- BLUE Race 11170 **876,00**
- GREEN Race 11172 **876,00**
- LIME Race 11174 **876,00**
- ORANGE Race 11176 **876,00**
- RED Race 11178 **876,00**
- SAND Race 11180 **876,00**
- VIOLET Race 11182 **876,00**
- WHITE Race 11184 **876,00**

#### Opaque transparent painting

- ANTHRACITE Opaque Race 11169 **1.121,00**
- BLUE Opaque Race 11171 **1.121,00**
- GREEN Opaque Race 11173 **1.121,00**
- LIME Opaque Race 11175 **1.121,00**
- ORANGE Opaque Race 11177 **1.121,00**
- RED Opaque Race 11179 **1.121,00**
- SAND Opaque Race 11181 **1.121,00**
- VIOLET Opaque Race 11183 **1.121,00**
- WHITE Opaque Race 11185 **1.121,00**

- my RACE colour RAL \_\_\_\_\_  Glossy Note 11187 **1.293,00**
- Opaque

### FLASH



#### Polished transparent painting

- BLUE Flash 11190 **876,00**
- WHITE Flash 11192 **876,00**
- RED Flash 11188 **876,00**

#### Polished transparent painting

- BLUE Opaque Flash 11191 **1.121,00**
- WHITE Opaque Flash 11193 **1.121,00**
- RED Opaque Flash 11189 **1.121,00**

#### Fork colour

- ☆ Opaque black
- Bright anthracite
- Bright orange
- Bright silver
- Bright blue
- Pearl white
- Bright fuchsia
- Bright lime
- Bright red

Date .....	Order .....	User .....	Address .....
------------	-------------	------------	---------------

**Backrest adjustment and fixing system**

Backrest with double locking (upright and folded) with rake adjustable from -4° to +16°  
 Backrest with upright locking system ONLY (no locking when folded) with rake adjustable from -4° to +16°  
 Fixed back(non-folding back) with rake adjustable from -4° to +16°

Integrated backrest (Banded, not folding back) 10841 1.248,00  
 Exclude installation of the titanium backrest

(.....) to the ground  (.....) to the ground

**Backrest**

Adjustable velcro straps and padded transpiring upholstery ☆ Carbon fibre backrest   
 Titanium backrest 1.047,00  
 Not available with: Integrated backrest (Banded, not folding back)

**AIR** Integrated posture backrest (NOT REMOVABLE) 1.047,00  
 Carbon shell - Lateral retaining 7,5cm  
 Depth adjustment ±1cm. - Angle adjustment ±10°  
 not available for seat width 48

<b>H 28</b> Backrest Height (TS) min 34 (.....)	<b>H 34</b> Backrest Height (TS) min 38 (.....)	<b>H 40</b> Backrest Height (TS) min 44 (.....)
Lateral retaining wing A=high - R=regular		
<b>A</b>  <input type="checkbox"/>	<b>R</b>  <input type="checkbox"/>	<b>A</b>  <input type="checkbox"/>
<b>R</b>  <input type="checkbox"/>	<b>A</b>  <input type="checkbox"/>	<b>R</b>  <input type="checkbox"/>

**Installation on:**  
 Backrest tubes (Carbon tubes with integrated backrest)   
 Carbon fibre backrest   
 Titanium backrest 1.047,00  
 Not available with: Integrated backrest (Banded, not folding back)

**Handle tube**









Tubes with short handle  
 SPORT tubes Without push handles (Lightest configuration)  
 Folding handles 02958 252,00

**Castors**

3" Sport (Lightest configuration)  
 4" Soft  
 3" Active Soft (wide) (Aluminium alloy rim)  
 4" Active Sport (narrow) (Aluminium alloy rim)  
 4" Active Soft (wide) (Aluminium alloy rim)  
 5" Active Soft (wide) (Aluminium alloy rim)  
 5" Pneumatic

**Rear wheels - See chart N°3**

24" ULTRA-LIGHT PROGEO KEY SPORT (Lightest configuration)  
 24" Ultra-light "Spinergy LX"  
 24" Ultra-light "Spinergy LXL" 04353 527,00  
 24" Ultra-light "Spinergy Flex rim" Integrated aluminium/rubber handrim  
 25" Ultra-light "Spinergy LX" Black hub and white spokes  Hub and spokes black  
 25" Ultra-light "Spinergy LXL" Black hub and white spokes  
 26" Ultra-light "Spinergy LX"

Date	Order	User	Address
<b>Rear wheel tyre</b>			
<input checked="" type="radio"/> High pressure tyre	(24"-25"-26")	(Lightest configuration)	
<input type="checkbox"/> High pressure profile tyre	(24")		
<input type="checkbox"/> Marathon Plus	(24"-25")	with anti-puncture protection	01669 <b>63,00</b>
<input type="checkbox"/> Anti-puncture - Colour Black	(24")		11083 <b>126,00</b>
<b>Handrim</b>			
	<b>Wheel distance</b>	<input checked="" type="checkbox"/> <b>3 cm</b>	<input type="checkbox"/> <b>4 cm</b>
<input checked="" type="radio"/> Aluminium	(24"-25"-26")	(Lightest configuration)	
<input type="checkbox"/> Aluminium black SOFT-TOUCH	(24"-25")	(24" handrim, on 25" wheel is installed with spacers)	09170 <b>126,00</b>
<input type="checkbox"/> Chromed Steel	(24"-25")	(24" handrim, on 25" wheel is installed with spacers)	01684 <b>148,00</b>
<input type="checkbox"/> Titanium	(24"-25")	(24" handrim, on 25" wheel is installed with spacers)	00016 <b>275,00</b>
<input type="checkbox"/> Ultra Grepp	(24"-25")	(24" handrim, on 25" wheel is installed with spacers)	00017 <b>315,00</b>
<input type="checkbox"/> Max Grepp	(24"-25")	(24" handrim, on 25" wheel is installed with spacers)	00834 <b>349,00</b>
<input type="checkbox"/> Ergo Para	(24")		00632 <b>349,00</b>
<input type="checkbox"/> TOP FRICTION	(24"-25")	(24" handrim, on 25" wheel is installed with spacers)	11023 <b>399,00</b>
Oval countour with a rubber insert			
<input type="checkbox"/> NOVA H	(24"-25")	(24" handrim, on 25" wheel is installed with spacers)	11025 <b>263,00</b>
Ergonomic black profile			
<input type="checkbox"/> NOVA D	(24"-25")	(24" handrim, on 25" wheel is installed with spacers)	11026 <b>286,00</b>
Ergonomic profile with rubber coating (ideal for quadriplegics)			
<input type="checkbox"/> SURGE LT	(25")	Oval countour with a rubber insert	06427 <b>360,00</b>
<input type="checkbox"/> Quad	(24")		00693 <b>200,00</b>
<input type="checkbox"/> Silicon cover for standard aluminium handrim		Available for measures (22" - 24" - 26")	04050 <b>160,00</b>
<b>Wheel locks</b>			
<input checked="" type="checkbox"/> Sport brake			
<input type="checkbox"/> Bent lever push to lock			
<input type="checkbox"/> Straight lever push to lock			
<input type="checkbox"/> Straight lever pull to lock			
<input type="checkbox"/> Brake with extension lever push to lock			
<input type="checkbox"/> Brake with extension lever pull to lock			
<b>Mudguard</b>			
<input checked="" type="checkbox"/> Carbon fibre mudguard			
<input type="checkbox"/> Carbon fibre Straight sideguard	<input checked="" type="checkbox"/> Aligned wheel	<input type="checkbox"/> Under wheel ..... cm	<input type="checkbox"/> Above wheel ..... cm
<input type="checkbox"/> Removable carbon fibre mudguard			04109 <b>252,00</b>
<input type="checkbox"/> Removable Carbon fibre straight sideguard	<input checked="" type="checkbox"/> Aligned wheel	<input type="checkbox"/> Under wheel ..... cm	<input type="checkbox"/> Above wheel ..... cm
			04109 <b>252,00</b>
<b>Armrests</b>			
<input type="checkbox"/> Tubular armrests	(Swing away, removable and height adjustable armrest)		 00694 <b>252,00</b>
<b>Accessories</b>			
<input type="checkbox"/> Pad for front frame protectors			07058 <b>52,00</b>
<input type="checkbox"/> Backrest-seat connection cloth			10241 <b>17,00</b>
<input type="checkbox"/> Removable storage bag (with quick coupling)			09811 <b>126,00</b>
<b>Optional 1</b>			
<input type="checkbox"/> Transit wheels			 03290 <b>148,00</b>
<input type="checkbox"/> Anti-tipper with rapid hookup	(inside rotation to reduce the encumbrance)		
	<input type="checkbox"/> Right		06821 <b>126,00</b>
	<input type="checkbox"/> Left		06822 <b>126,00</b>
<b>Optional 2</b>			
<input checked="" type="checkbox"/> Safety pelvic belt			03972 <b>63,00</b>
<input checked="" type="checkbox"/> Harness			04103 <b>126,00</b>
<input type="checkbox"/> Lumbar support	(to insert in the backrest upholstery)		00013 <b>40,00</b>
<input type="checkbox"/> Tetraclip	(Quick release axle for quadriplegic)		03947 <b>177,00</b>
<b>Additional Kit</b>			
<input type="checkbox"/> 24" Off-road rear wheels	Off-Road tyre - aluminium handrim (black colour)		03378 <b>498,00</b>
<input type="checkbox"/> 24" FAT rear wheels	FAT tyre 3" - aluminium handrim (black colour)		09357 <b>876,00</b>

Date ..... Order ..... User ..... Address .....

**PHYSIO - Posture backrest**  
**(Std. Backrest upholstery not provided)**

Removable with quick release  
 Suitable for tubes with diameter 18+26mm  
 Depth adjustment (4cm)  
 Angle adjustment (±18°)

- AIR** Carbon shell  
 not available for seat width 48

BACKREST HEIGHT	28	34	40	
Shell's shape 	Lateral retaining wing A=high - R=regular			
	A	R	A	R
	<input type="checkbox"/>	<input type="checkbox"/>	<input type="checkbox"/>	<input type="checkbox"/>

1.047,00

- POSTURE** Aluminum shell

BACKREST HEIGHT	34	40	52	
Shell's shape 	Lateral retaining wing B=regular			
	R	R	R	
	<input type="checkbox"/>	<input type="checkbox"/>	<input type="checkbox"/>	

1.013,00

**Configuration DEEP with side support PAD (height adjustable)**

- Aluminum lateral with padded, breathable upholstery.



Small (h 13cm)	Large (h 20cm)
<input type="checkbox"/> Right 10272	<input type="checkbox"/> Right 10273
29,00	40,00
<input type="checkbox"/> Left 10272	<input type="checkbox"/> Left 10273
29,00	40,00

**SWING AWAY - Lateral support**

Fixing and adjustment hardware complete with protection sleeve  
 Aluminum lateral with padded, breathable upholstery.

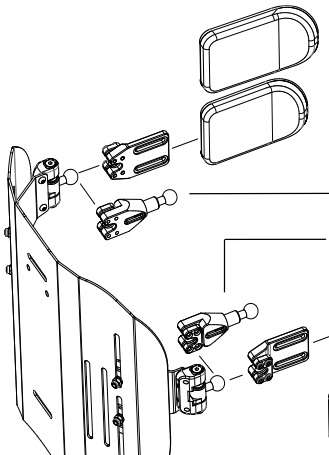

<input type="radio"/> Large (18x12)	05647	183,00
<input type="radio"/> Small (14x9)	05643	183,00
<input type="radio"/> Lateral support extension	Quantity (number pcs).....	
<input type="radio"/> Lateral support extension	10271	69,00
<input type="radio"/> Small (14x9)	05642	183,00
<input type="radio"/> Large (18x12)	05646	183,00

- Headrest adjustable - Double ball mounting system  
 Available only with backrest Physio  
 Not available for backrest Physio AIR carbon shell



<input type="checkbox"/> Large (34x14)	05648	252,00
<input type="checkbox"/> Small (28x14)		

Date	Order	User	Address
------	-------	------	---------

### REFERENCE TABLES

**Progeo (Español)** NOIR is a wheelchair without possibilities of adjustments after its manufacturing.  
 (1) The real seat depth, from the front part of the seat cloth to the backrest tube will be 1,5 cm more than the declared one.

1	A Footplate width			
	DP	35÷39	40÷45	46÷50
LS				
33		21,5	21	20,5
36		24,5	24	23,5
39		27,5	27	26,5
42		30,5	30	29,5
45		33,5	33	32,5
48		36,5	36	35,5

2	Setting	C :
	Extremely prudential	7,5
	Prudential	9
	Standard	10,5
	Active	12
	Extreme	13,5

3	Maximum width
Camber	
0°	LS + 18
2°	LS + 21
4°	LS + 24

Maximum width calculated including 3 cm. distance between tyre and handrim

Wheelchair : Progeo noir 2.0 - Rev. 2023.2	Prices - VAT excluded to be added to the price list	<div style="border: 1px solid black; padding: 2px;"> <p style="text-align: center; margin: 0;">Send this page only if any optional have been chosen</p> <p>☆ standard (supplied if no requests are indicated)</p> <p><input type="checkbox"/> on request (without extra charge)</p> <p><input type="checkbox"/> optional (cost to be added at the basic price)</p> </div>
--	--	---