

Date

UK (English)

User

Company stamp

End user weight (kg)

Folding frame wheelchair

Language user manual

Responsible

£ 2690,00

Retail price - VAT not included

Wheelchair measures	
Seat width (LS)	<input type="checkbox"/> 36 <input type="checkbox"/> 39 <input type="checkbox"/> 42 <input type="checkbox"/> 45 <input type="checkbox"/> 48
Seat depth (PS)	<input type="checkbox"/> 37,5 <input type="checkbox"/> 40 <input type="checkbox"/> 42,5 <input type="checkbox"/> 45 <input type="checkbox"/> 47,5
The real seat depth, from the front part of the seat cloth to the backrest tube will be 1 cm more than the declared one. - calculated with angle backrest 90° to the seat	
Footplate distance (DP) (cm) ±0.5cm - adjustment steps 1.5cm
(Real distance between seat and footplate) - IMPORTANT NOTICE! From the footplate to the floor minimum 4cm !! (Minimum Front height = DP + 4cm.)	
Setting	☆ Standard <input type="checkbox"/> Prudential <input type="checkbox"/> Active
camber	☆ 2° <input type="checkbox"/> 0° <input type="checkbox"/> 4°
Backrest Height (TS)	Std.Value 33,5(min 24.5-max 47) adjustment steps 1.5cm
Backrest angle (to the seat)	☆ 90° <input type="checkbox"/> -6° <input type="checkbox"/> 6°
Front height (STD 49) - Rear height (STD 43)	

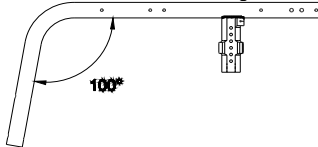
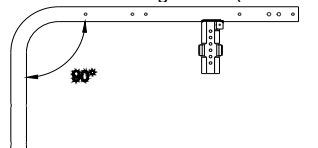
Front frame		Frame colour
<input checked="" type="checkbox"/> Aluminium standard frame Angle 100° 	<input type="checkbox"/> Short frame - Ideal with Seat depth (PS)37,5 - 40 <input type="checkbox"/> Long frame - Ideal with Seat depth (PS)42,5 - 45 - 47,5	<input type="checkbox"/> Bright silver <input type="checkbox"/> Opaque black <input type="checkbox"/> Pearl white <input checked="" type="radio"/> Opaque orange 08341 63,00
<input type="checkbox"/> Aluminium frame Angle 90° - (max 5" caster) 	<input type="checkbox"/> Short frame - Ideal with Seat depth (PS)37,5 - 40 <input type="checkbox"/> Long frame - Ideal with Seat depth (PS)42,5 - 45 - 47,5	

Backrest
 ☆ Adjustable velcro straps and padded transpiring upholstery

Handle tube
 ☆ Tubes with standard handle

Folding handles



02958 **252,00**

Casters

☆ 4" Soft

3" Sport

5" Soft

6" Soft (Available only with 100° angle)

6" Pneumatic (Available only with 100° angle)

3" Active Soft (wide) (Aluminium alloy rim) 06824 **126,00**

4" Active Sport (narrow) (Aluminium alloy rim) 01398 **126,00**

4" Active Soft (wide) (Aluminium alloy rim) 03943 **126,00**

5" Active Soft (wide) (Aluminium alloy rim) 07518 **126,00**

5" Pneumatic 10844 **63,00**

Support front fork

☆ Standard support front fork



Front fork support V Design 2.0
 Exclude the installation of QUICK RELEASE FRONT FORKS



06850 **148,00**

Date Order User Address

Colour set: Rear wheels and forks - To be matched only with: Rear wheels Ultra-light Progeo - Standard! (22 - 24)

<input checked="" type="radio"/> Polished black	22" 24" 25" 26"		
<input type="radio"/> Bright silver	22" 24"	00833	126,00
<input type="radio"/> Bright anthracite	24"	00833	126,00
<input type="radio"/> Bright orange	22" 24"	00833	126,00
<input type="radio"/> Bright fuchsia	22" 24"	00833	126,00
<input type="radio"/> Bright blue	22" 24"	00833	126,00
<input type="radio"/> Bright red	22" 24"	00833	126,00
<input type="radio"/> Bright lime	22" 24"	00833	126,00
<input type="radio"/> Pearl white	22" 24"	00833	126,00

Rear wheels

<input checked="" type="radio"/> 24" Ultra-light Progeo - Standard!			
<input type="radio"/> 22" Ultra-light Progeo - Standard!			
<input type="radio"/> 25" Ultra-light Progeo - Standard!	(colour: black)		
<input type="radio"/> 26" Progeo - Standard!	(colour: black)		
<input type="radio"/> 24" ULTRA-LIGHT PROGEO KEY SPORT	Weight reduction approx. 450gr.	04383	876,00
<input type="radio"/> 24" Ultra-light "Spinergy LX"		01685	876,00
<input type="radio"/> 24" Ultra-light "Spinergy LXL"	<input type="checkbox"/> Black hub and white spokes <input type="checkbox"/> Hub and spokes black	07846	876,00
<input type="radio"/> 24" Ultra-light "Spinergy Flex rim"	Integrated aluminium/rubber handrim	02270	1.374,00
<input type="radio"/> 25" Ultra-light "Spinergy LX"		02101	876,00
<input type="radio"/> 25" Ultra-light "Spinergy LXL"	<input type="checkbox"/> Black hub and white spokes	07847	876,00
<input type="radio"/> 26" Ultra-light "Spinergy LX"		02102	876,00
<input type="radio"/> 24" Off-road (aluminium handrim black)		01392	224,00
<input type="radio"/> 22" with brake handles for companion (drum brake) (aluminium handrim) Available only with: camber 0° and Setting Standard		03385	360,00
<input type="radio"/> 24" with brake handles for companion (drum brake) (aluminium handrim) Available only with: camber 0° and Setting Standard		03384	360,00
<input type="radio"/> One arm drive - (24" rear wheels Aluminium handrim High pressure Tyre) - camber 0° <input type="radio"/> Right <input type="radio"/> Left		02103	401,00

Rear wheel tyre

<input checked="" type="radio"/> High pressure tyre	(22"-24"-25"-26")		
<input type="radio"/> High pressure profile tyre	(24")		
<input type="radio"/> Marathon Plus	(24"-25")	with anti-puncture protection	01669 63,00
<input type="radio"/> Anti-puncture - Colour Black	(24")		11083 126,00
<input type="radio"/> Anti-puncture - Colour Grey	(22")		04181 98,00

Handrim **Wheel distance** 3 cm 4 cm

<input checked="" type="radio"/> Aluminium	(22"-24"-25"-26")		
<input type="radio"/> Aluminium black SOFT-TOUCH	(24"-25")	(24" handrim, on 25" wheel is installed with spacers)	09170 126,00
<input type="radio"/> Chromed Steel	(24"-25")	(24" handrim, on 25" wheel is installed with spacers)	01684 148,00
<input type="radio"/> Titanium	(24"-25")	(24" handrim, on 25" wheel is installed with spacers)	00016 275,00
<input type="radio"/> Ultra Grepp	(24"-25")	(24" handrim, on 25" wheel is installed with spacers)	00017 315,00
<input type="radio"/> Max Grepp	(24"-25")	(24" handrim, on 25" wheel is installed with spacers)	00834 349,00
<input type="radio"/> Ergo Para	(24")		00632 349,00
<input type="radio"/> TOP FRICTION	(24"-25")	(24" handrim, on 25" wheel is installed with spacers)	11023 399,00
<input type="radio"/> Oval countour with a rubber insert			
<input type="radio"/> NOVA H Ergonomic black profile	(24"-25")	(24" handrim, on 25" wheel is installed with spacers)	11025 263,00
<input type="radio"/> NOVA D Ergonomic profile with rubber coating (ideal for quadriplegics)	(24"-25")	(24" handrim, on 25" wheel is installed with spacers)	11026 286,00
<input type="radio"/> SURGE LT	(25")	Oval countour with a rubber insert	06427 360,00
<input type="radio"/> Quad	(24")		00693 200,00
<input type="radio"/> Silicon cover for standard aluminium handrim		Available for measures (22"- 24" - 26")	04050 160,00

Wheel locks

<input checked="" type="radio"/> Bent lever push to lock			
<input type="radio"/> Straight lever push to lock			
<input type="radio"/> Straight lever pull to lock			
<input type="radio"/> Sport brake		06428	126,00
<input type="radio"/> Brake with extension lever push to lock		01949	63,00
<input type="radio"/> Brake with extension lever pull to lock		03372	63,00

Date Order User Address

Footplate - See reference tables N°3

- Automatic Closure footplate rake and depth adjustable
 Minimum footplate distance 35cm. Internal 2/3 Internal External  11526 no list
 Minimum footplate distance 30cm. Available only with Multi-function and rotative system - 03945 189,00

- One piece footplate - Flip-up! rake and depth adjustable
 Minimum footplate distance 35cm. Internal 2/3 Internal External  11527 no list
 Minimum footplate distance 30cm. Available only with Multi-function and rotative system - 03945 189,00

- One piece aluminium footplate - Flip-up! rake and depth adjustable
 Minimum footplate distance 35cm. Internal 2/3 Internal 2/3 External External  11528 no list

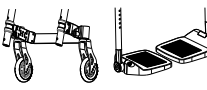
- Plastic footrest rake adjustable
 Minimum footplate distance 35cm. 2/3 Internal 2/3 External  06861 86,00
 Need a stretch calf band.
NOT AVAILABLE WITH FRONT FORK SUPPORT V DESIGN 2.0

- One piece Carbon fibre footplate rake adjustable, swing away, flip-up.
 Minimum footplate distance 35cm. Internal External  03291 275,00

- Footplate COMPACT, automatic Closure, rake and depth adjustable
 Minimum footplate distance 35cm. Internal External  09957 252,00

Mudguard

- Mudguard**
- ABS mudguard
 - ABS Straight sideguard
 - Carbon fibre mudguard
 - Carbon fibre Straight sideguard
- 
- 03946 315,00
-
- 08918 315,00
-
-
- Removable version**
- Removable ABS mudguard
 - Removable ABS fibre straight sideguard
 - Removable carbon fibre mudguard
 - Removable Carbon fibre straight sideguard
- 
- 08921 126,00
-
- 08921 126,00
-
- 08919 435,00
-
- 08920 435,00

Armrests

- Tubular armrests - Steel support with safety locking system
 (Swing away, removable and height adjustable armrest)  00694 252,00

- Removable armrest with ABS mudguard**

 Desk armrests PROGEO (Removable and height adjustable)  09956 224,00

- Removable armrest with ABS straight sideguard  08881 224,00
 Removable armrest with carbon-fiber straight sideguard 08882 453,00





Accessories

- Pad for front frame protectors 07058 52,00
- Backrest-seat connection cloth 10241 17,00
- Removable storage bag (with quick coupling) 09811 126,00



Date Order User Address

Optional 1

Only one optional devices for side can be chosen

<input type="radio"/> Transit wheels	Exclude the installation of : Anti-tippers - Tipping aid - Crutches support		00836	148,00
<input type="radio"/> Anti-tipper with rapid hookup	(inside rotation to reduce the encumbrance) <input type="radio"/> Right <input type="radio"/> Left		00023 00024	126,00 126,00
<input type="radio"/> Tipping aid	<input type="radio"/> Right <input type="radio"/> Left		00025 01046	74,00 74,00
<input type="radio"/> Crutches support	<input type="radio"/> Right <input type="radio"/> Left		00838 00837	74,00 74,00

Optional 2

<input type="radio"/> Tetracrip	(Quick release axle for quadriplegic)		03947	177,00
<input type="radio"/> Quick release front forks	To be matched only with: Standard support front fork		00030	148,00
<input type="radio"/> Push handles for companion	(Removable and height adjustable)		01048	189,00
<input type="radio"/> Safety pelvic belt			03972	63,00
<input type="radio"/> Harness			04103	126,00
<input type="radio"/> Lumbar support	(to insert in the backrest upholstery)		00013	40,00
<input type="radio"/> Swing away lateral support Not available with Posture backrest PHYSIO	<input type="radio"/> Right <input type="radio"/> Left		02097 02098	252,00 252,00
<input type="radio"/> Spoke guards Black	(22"-24")		01043	148,00
<input type="radio"/> Spoke guards Transparent	(22"-24")		00835	148,00
<input type="radio"/> Spoke guards Progeo design	(22"-24")		00019	177,00
<input type="radio"/> Spoke guards Dragon	(22"-24")		02106	177,00

Additional Kit

<input type="radio"/> 24" Off-road rear wheels	Off-Road tyre - aluminium handrim (black colour)		03378	498,00
<input type="radio"/> 24" FAT rear wheels	FAT tyre 3" - aluminium handrim (black colour)		09357	876,00

Date Order User Address

PHYSIO - Posture backrest (Std. Backrest upholstery not provided)

Removable with quick release
Suitable for tubes with diameter 18±26mm
Depth adjustment (4cm)
Angle adjustment (±18°)

- AIR** Carbon shell
not available for seat width 48

BACKREST HEIGHT	28	34	40			
Shell's shape  7,5 cm	Lateral retaining wing A=high - R=regular					
	A	R	A	R	A	R
	<input type="checkbox"/>	<input type="checkbox"/>	<input type="checkbox"/>	<input type="checkbox"/>	<input type="checkbox"/>	<input type="checkbox"/>

1.047,00

- POSTURE** Aluminum shell

BACKREST HEIGHT	34	40	52			
Shell's shape  7,5 cm	Lateral retaining wing B=regular					
	R	R	R			
	<input type="checkbox"/>	<input type="checkbox"/>	<input type="checkbox"/>			

1.013,00

Configuration DEEP with side support PAD (height adjustable)

- Alluminum lateral with padded, breathable upholstery.



Small (h 13cm)



Right
10272

29,00



Left
10272

29,00

Large (h 20cm)



Right
10273

40,00



Left
10273

40,00

SWING AWAY - Lateral support

Fixing and adjustment hardware complete with protection sleeve
Alluminum lateral with padded, breathable upholstery.

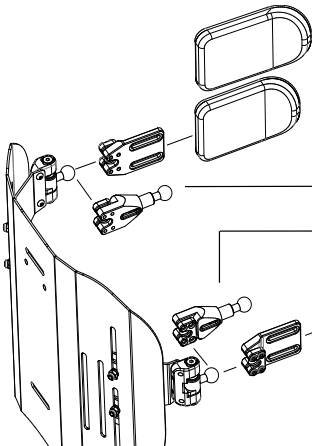

- Large (18x12)

05647 183,00

- Small (14x9)

05643 183,00

- Lateral support extension

Quantity (number pcs).....
10271 69,00

- Lateral support extension

Quantity (number pcs).....

- Small (14x9)

05642 183,00

- Large (18x12)

05646 183,00

- Headrest adjustable - Double ball mounting system

Available only with backrest Physio
Not available for backrest Physio AIR carbon shell



Large (34x14) 05648 252,00
 Small (28x14)

customer_support_uk@permobil.com - https://www.permobil.com/en-gb

Permobil Limited Unit 7, Polaris Centre, 41 Brownfields, Welwyn Garden City, Herts, AL7 1AN United Kingdom - Phone: +44 1484 722888

customer_support_uk@permobil.com - https://www.permobil.com/en-gb

Date	Order	User	Address
------------	-------------	------------	---------------



Note

Wheelchair : Progeo TEKNA ADVANCE - Rev. 2023.1

Prices - VAT excluded
to be added to the price list

Send this page only if any optional have been chosen	
<input checked="" type="checkbox"/> ☆	standard <small>(supplied if no requests are indicated)</small>
<input type="checkbox"/>	on request <small>(without extra charge)</small>
<input type="checkbox"/> ○	optional <small>(cost to be added at the basic price)</small>

REFERENCE TABLES

1		Front height			
		With closed frame (95°) max 5" caster			
		With closed frame (90°) max 5" caster			
		With closed frame (85°) max 4" caster			
		Casters			
FORK		3"	4"	5"	6"
SMALL 		max 49	max 50	max 51	
MEDIUM 		max 53	max 54	max 55	max 57
The size of the fork will be defined only by Progeo in accordance with wheelchair final configuration.					

2		Rear height			
		Rear wheels			
		22"	24"	25"	26"
H min		min. 36	min. 38	min. 39	min. 40
H max		max 44	max 48	max 49	max 51

3	Footplate option	Footplate distance
	Automatic Closure footplate	min. 36
	Automatic Closure footplate , with multifunction rotative system	min. 31
	One piece footplate - Flip-up!	min. 36
	One piece footplate - Flip-up!, with multifunction rotative system	min. 31
	One piece aluminium footplate - Flip-up!	min. 36
	Plastic footrest	min. 36
	One piece Carbon fibre footplate	min. 36
Calculated with the best configuration and with the footplates positioned on inside.		
IMPORTANT NOTICE! From the footplate to the floor minimum 4cm !! (Minimum Front height = DP + 4cm.)		

4		Rear wheels
Model	Features	
22" Ultra-light Progeo - Standard!	(not available in anthracite color)	
24" Ultra-light Progeo - Standard!	(available for all colors)	
24" ULTRA-LIGHT PROGEO KEY SPORT	(silver hub, black rim and 16 spokes)	
24" Ultra-light "Spinergy LX"	(silver hub, black rim and spokes)	
24" Ultra-light "Spinergy LXL"	(black hub and rim, 18 white spokes) - (black hub, rim and 18 spokes)	
24" Ultra-light "Spinergy Flex rim"	(silver hub, black rim and spokes) - (integrated aluminium/rubber handrim - encumbrance reduction up to 3cm. - all tyre)	
24" Off-road	(colour: black) - (aluminium handrim - tyre Off-road)	
25" Ultra-light "Spinergy LX"	(silver hub, black rim and spokes)	
25" Ultra-light "Spinergy LXL"	(black hub and rim, 18 white spokes)	
26" Progeo - Standard!	(colour: black)	
26" Ultra-light "Spinergy LX"	(silver hub, black rim and 18 spokes)	