

Folding frame wheelchair

Date .....

User name .....

Company stamp

Responsible .....

### Wheelchair measures

Seat width (LS)                    33   36   39   42   45   48

Seat depth (PS)                    35   37,5   40   42,5   45   47,5

The real seat depth, from the front part of the seat cloth to the backrest tube will be 1 cm more than the declared one.

Footplate distance (DP) .....

(Real distance between seat and footplate)

**IMPORTANT NOTICE! From the footplate to the floor minimum 4cm.!! (Minimum Front height = DP + 4cm.)**

Setting                                ☆ Standard                     Prudential                     Active                     Extreme

Backrest Height (TS)                Std.Value 36 .....(min 30-max 54)

Crossbrace (black)                ☆ Single                     Double (Not seat width 33-36)

Rear wheel camber                ☆ 0°                     2°                     4°

Front height ..... (STD 49) - Rear height ..... (STD 44)

### Carbon fibre frame - Opaque transparent painting

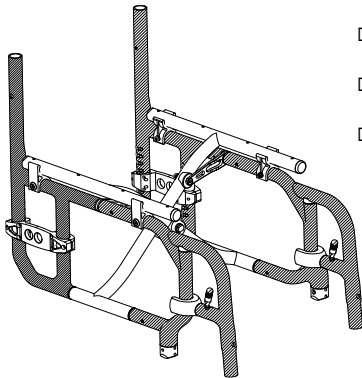

Short frame - Ideal with Seat depth (PS) 35 - 37,5

Medium frame - Ideal with Seat depth (PS) 40 - 42,5

Long frame - Ideal with Seat depth (PS) 45 - 47,5

### Front frame angle

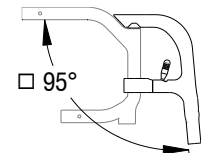
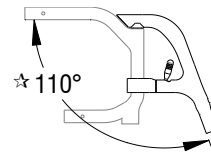

### Colour set: Rear wheels, wheel plates and forks - To be matched only with: Rear wheels Ultra-light Progeo - Standard!

☆ Black	22" 24" 25" 26"		
○ Bright silver	22" 24"	00833	£ 109
○ Bright anthracite	24"	00833	£ 109
○ Bright orange	22" 24"	00833	£ 109
○ Bright fuchsia	22" 24"	00833	£ 109
○ Bright blue	22" 24"	00833	£ 109
○ Bright red	22" 24"	00833	£ 109
○ Bright lime	22" 24"	00833	£ 109
○ Pearl white	24"	00833	£ 109

### Handle tube

- ☆ Handle tube STD
- Handle tube with short tubes
- Folding handles aluminium



02958                    £ 218

### Casters

- ☆ 5" Soft
- 4" Soft
- 3" Sport
- 6" Soft
- 6" Pneumatic
- 3" Active Soft (wide)                    (Aluminium alloy rim)                    06824                    £ 109
- 4" Active Sport (narrow)                    (Aluminium alloy rim)                    01398                    £ 109
- 4" Active Soft (wide)                    (Aluminium alloy rim)                    03943                    £ 109
- 5" Active Soft (wide)                    (Aluminium alloy rim)                    07518                    £ 109
- 5" Pneumatic                    10844                    £ 55

English

Date ..... Order ..... User name ..... Address .....

**Rear wheels**

- ☆ 24" Ultra-light Progeo - Standard!
- 22" Ultra-light Progeo - Standard!
- 25" Ultra-light Progeo - Standard! (colour: black)
- 26" Progeo - Standard! (colour: black)
- 24" ULTRA-LIGHT PROGEO KEY SPORT **Weight reduction approx. 450gr.** 04383 **£ 764**
- 24" Ultra-light "Spinergy LX" 01685 **£ 764**
- 24" Ultra-light "Spinergy LXL"  Black hub and white spokes  Hub and spokes black 07846 **£ 764**
- 25" Ultra-light "Spinergy LX" 02101 **£ 764**
- 25" Ultra-light "Spinergy LXL"  Black hub and white spokes 07847 **£ 764**
- 26" Ultra-light "Spinergy LX" 02102 **£ 764**
- 24" Off-road (aluminium handrim black) 01392 **£ 196**
- 22" with brake handles for companion (drum brake) (aluminium handrim black) **Available only with camber 0°** 03385 **£ 316**
- 24" with brake handles for companion (drum brake) (aluminium handrim black) **Available only with camber 0°** 03384 **£ 316**
- One arm drive - (24" rear wheels Aluminium handrim High pressure Tyre) - camber 0°  
 Right  Left 02103 **£ 349**

**Rear wheel tyre**

- ☆ High pressure tyre (22"-24"-25"-26")
- High pressure profile tyre (24")
- Marathon Plus (24"-25") with anti-puncture protection 01669 **£ 55**
- Solid tyre Kik Mako - Colour Black (24") 01041 **£ 109**
- Solid tyre Kik Mako - Colour Grey (24") 01751 **£ 109**
- Anti-puncture - Colour Grey (22") 04181 **£ 87**

**Handrim - Wheel distance**

☆ 3 cm  4 cm



- ☆ Aluminium (22"-24"-25"-26")
- Aluminium black SOFT-TOUCH (24"-25") (24" handrim, on 25" wheel is installed with spacers) 09170 **£ 109**
- Chromed Steel (24"-25") (24" handrim, on 25" wheel is installed with spacers) 01684 **£ 131**
- Titanium (24"-25") (24" handrim, on 25" wheel is installed with spacers) 00016 **£ 240**
- Ultra Grepp (24"-25") (24" handrim, on 25" wheel is installed with spacers) 00017 **£ 273**
- Max Grepp (24"-25") (24" handrim, on 25" wheel is installed with spacers) 00834 **£ 305**
- Ergo Para (24") 00632 **£ 305**
- SURGE LT (24"-25") Oval countour with a rubber insert 06427 **£ 316**
- Quad (24") (24") 00693 **£ 175**
- Silicon cover for standard aluminium handrim Available for measures (22"- 24" - 26") 04050 **£ 142**

**Wheel locks**

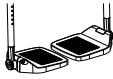
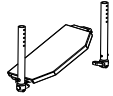
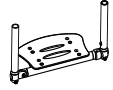

- ☆ Bent lever push to lock 
- Straight lever Push to lock 
- Straight lever Pull to lock 
- Sport brake  06428 **£ 109**
- Brake with extension lever push to lock  01949 **£ 55**
- Brake with extension lever pull to lock  03372 **£ 55**

English  
Date ..... Order ..... User name ..... Address .....

**Footplate - See reference tables N°3**





- ☆ Plastic footrest, rake adjustable  
Not available with Elevating front frame, swing away and removable  
Minimum footplate distance 31cm      ☆2/3 Internal    □ 2/3 External 
- One piece footplate - Flip-up! rake and depth adjustable  
Not available with Elevating front frame, swing away and removable  
Minimum footplate distance 29cm      □ Internal    ☆2/3 Internal    □ External 
- Minimum footplate distance 24cm. Available only with Multi-function and rotative system - 03945    £ 164,00
- One piece aluminium footplate - Flip-up! rake and depth adjustable  
Not available with Elevating front frame, swing away and removable  
Minimum footplate distance 29cm.      □ Internal    ☆2/3 Internal    □ 2/3 External    □ External 
- One piece Carbon fibre footplate rake adjustable, swing away, flip-up.  
Not available with Elevating front frame, swing away and removable  
Minimum footplate distance 29cm.      ☆ Internal    □ External       03291    £ 240

**Mudguard**

- Mudguard - FIXED**
- ☆ ABS mudguard       03946    £ 273
  - ABS Straight sideguard      08918    £ 273
  - Carbon fibre mudguard
  - Carbon fibre Straight sideguard
- Mudguard - REMOVABLE**
- Removable ABS mudguard      08921    £ 109
  - Removable ABS fibre straight sideguard      08921    £ 109
  - Removable carbon fibre mudguard      08919    £ 382
  - Removable Carbon fibre straight sideguard      08920    £ 382
- Removable armrest with ABS mudguard**
- Desk armrests PROGEO (Removable and height adjustable)       09956    £ 196
  - Removable armrest with ABS straight sideguard      08881    £ 196
  - Removable armrest with carbon-fiber straight sideguard       08882    £ 393
- Kind of pad to be mounted on chosen armrest**
- ☆ Pad STANDARD
  - Ergonomic pad (30x6 cm.)      04104    £ 55

**Optional 1**

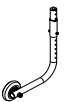
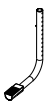
**Only two optional devices for side can be chosen**

- Swing away armrests - Steel support with safety locking system  
(Swing away, removable and height adjustable armrest)       00694    £ 218
- ☆ Pad STANDARD      04104    £ 55
- Ergonomic pad (30x6 cm.)
- Transit wheels       00836    £ 131
- Anti-tipper with rapid hookup (inside rotation to reduce the encumbrance)       00023    £ 109
- Right      00024    £ 109
- Left
- Tipping aid       00025    £ 65
- Right      01046    £ 65
- Left
- Crutches support       00838    £ 65
- Right      00837    £ 65
- Left

Rehateam s.r.l. Vicolo Negrelli, 5 - 31040 Castagnole di Paese (TV) - Tel. +39.0422.484657 / +39.0422.480387 - Fax +39.0422.484661 / +39.0422.484684  
P.IVA IT 03182520266 - C.C.I.A.A. TV n.225867 - Iscr.Trib. TV n.41690 Capitale Sociale I.V. Euro 100.000,00

Email: info@rehateamprogeo.com - web: http://www.rehateamprogeo.com



English

Date ..... Order ..... User name ..... Address .....

**Accessories**

- |   |  |       |       |
|---|--|-------|-------|
| <input type="radio"/> Pad for front frame protectors              |  | 07058 | £ 44  |
| <input type="radio"/> Backrest-seat connection cloth              |  | 10241 | £ 16  |
| <input type="radio"/> Removable storage bag (with quick coupling) |  | 09811 | £ 109 |

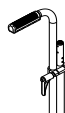
**Optional 2**

- |  |   |   |                |                |
|--|---|---|----------------|----------------|
| <input type="radio"/> Tetraclic                  | (Quick release axle for quadriplegic)                     |   | 03947          | £ 153          |
| <input type="radio"/> Push handles for companion | (Removable and height adjustable)                         |   | 01048          | £ 164          |
| <input type="radio"/> Harness                    |   |   | 04103          | £ 109          |
| <input type="radio"/> Safety pelvic belt         |   |   | 03972          | £ 55           |
| <input type="radio"/> Tray table (removable)     |   |   | 00508          | £ 240          |
| <input type="radio"/> Lumbar support             | (to insert in the backrest upholstery)                    |   | 00013          | £ 33           |
| <input type="radio"/> Super Head rest            | (Folding with the wheelchair)                             |  | 04049          | £ 393          |
| <input type="radio"/> Swing away lateral support | <input type="radio"/> Right<br><input type="radio"/> Left |  | 02097<br>02098 | £ 218<br>£ 218 |
| Not available with Posture backrest PHYSIO       |   |   |                |                |
| <input type="radio"/> Spoke guards Black         | (22"-24")   |   | 01043          | £ 131          |
| <input type="radio"/> Spoke guards Transparent   | (22"-24")   |   | 00835          | £ 131          |
| <input type="radio"/> Spoke guards Progeo design | (22"-24")   |   | 00019          | £ 153          |
| <input type="radio"/> Spoke guards Dragon        | (22"-24")   |   | 02106          | £ 153          |

**Additional Kit**

- |  |  |       |       |
|--|--|-------|-------|
| <input type="radio"/> 24" Off-road rear wheels | Off-Road tyre - aluminium handrim (black colour) | 03378 | £ 436 |
| <input type="radio"/> 24" FAT rear wheels      | FAT tyre 3" - aluminium handrim (black colour)   | 09357 | £ 764 |

Date ..... Order ..... English User name ..... Address .....

**PHYSIO - Posture backrest - Std. Backrest upholstery not provided**

Removable with quick release  
Suitable for tubes with diameter 18÷26mm  
Depth adjustment (4cm)  
Angle adjustment ( $\pm 18^\circ$ )

**AIR** Carbon shell  
not available for seat width 48

BACKREST HEIGHT	28	34	40	£ 916		
Shell's shape	Lateral retaining wing A=high - R=regular					
	A	R	A	R	A	R
	<input type="checkbox"/>	<input type="checkbox"/>	<input type="checkbox"/>	<input type="checkbox"/>	<input type="checkbox"/>	<input type="checkbox"/>

**POSTURE** Aluminum shell

BACKREST HEIGHT	34	40	52	£ 884
Shell's shape	Lateral retaining wing B=regular			
	R	R	R	
	<input type="checkbox"/>	<input type="checkbox"/>	<input type="checkbox"/>	

**Configuration DEEP with side support PAD (height adjustable)**

Aluminum lateral with padded, breathable upholstery.



Small (h 13cm)



Right 10272

£ 27

Left 10272

£ 27

Large (h 20cm)



Right 10273

£ 33

Left 10273

£ 33

**SWING AWAY - Lateral support**

Fixing and adjustment hardware complete with protection sleeve  
Alluminum lateral with padded, breathable upholstery.

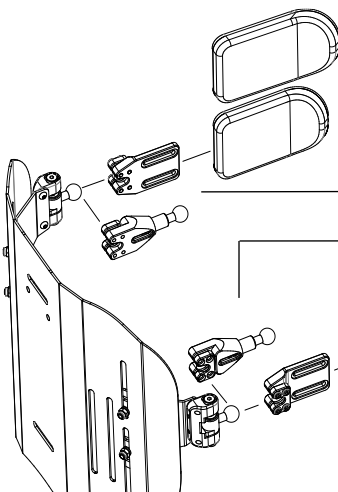

Large (18x12)

05647 £ 164

Small (14x9)

05643 £ 164

Lateral support extension

Quantity (number pcs).....

10271 £ 60

Lateral support extension

Quantity (number pcs).....

Small (14x9)

05642 £ 164

Large (18x12)

05646 £ 164

Headrest adjustable - Double ball mounting system  
Available only with backrest Physio  
Not available for backrest Physio AIR carbon shell

Large (34x14)  
 Small (28x14)



05648 £ 218

English

Date ..... Order ..... User name ..... Address .....

Empty form field for additional information.

Large empty form field for detailed order information.

Empty form field for additional information.

**Note**

Large empty form field for notes.

Italia Certified company normative UNI EN ISO 9001

Important notices page only if any optional have been chosen

- standard** (supplied if no requests are indicated)
- on request** (without extra charge)
- optional** (cost to be added at the basic price)

## Enclosure to wheelchair order form Vario Carbon

### REFERENCE TABLES

1	Front height	
<b>With closed frame (95°) max 5" caster</b>		
Casters	Front height	
	min.	max
3"	41	49
4"	42	50
5"	44	51
6"	48	52
<b>The size of the fork will be defined only by Rehateam Progeo in accordance with wheelchair final configuration.</b>		

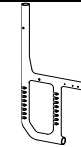
2		Rear height			
Rear frame		Rear wheels			
		22"	24"	25"	26"
CARBON		min. 37 max 46	min. 39 max 48	min. 40 max 49	min 41 max 50

3	Footplate option	Footplate distance	
		Frame Angle 110°	Frame Angle 95°
	Plastic footrest	min. 30	min. 31
	One piece footplate - Flip-up!	min. 28	min. 29
	One piece footplate - Flip-up! , with multifunction rotative system	min. 23	min. 24
	One piece aluminium footplate - Flip-up!	min. 28	min. 29
	One piece Carbon fibre footplate	min. 28	min. 29
<b>Calculated with the best configuration and with the footplates positioned on inside.</b>			
<b>IMPORTANT NOTICE! From the footplate to the floor minimum 4cm.!! (Minimum Front height = DP + 4cm.)</b>			

4	Rear wheels	
	Model	Features
	22" Ultra-light Progeo - Standard!	(not available in anthracite color)
	24" Ultra-light Progeo - Standard!	(available for all couloers)
	24" ULTRA-LIGHT PROGEO KEY SPORT	(silver hub, black rim and 16 spokes)
	24" Ultra-light "Spinergy LX"	(silver hub, black rim and spokes)
	24" Ultra-light "Spinergy LXL"	(black hub and rim, 18 white spokes) - (black hub, rim and 18 spokes)
	24" Off-road	(colour: black) - (aluminium handrim - tyre Off-road)
	25" Ultra-light "Spinergy LX"	(silver hub, black rim and spokes)
	25" Ultra-light "Spinergy LXL"	(black hub and rim, 18 white spokes)
	26" Progeo - Standard!	(colour: black)
	26" Ultra-light "Spinergy LX"	(silver hub, black rim and 18 spokes)