



Customer Contact Details

Customer Name: _____

Advisor: _____

Address: _____

Phone: _____

Email: _____

Ship to Customer Address:

Shipping Name: _____

Shipping Address: _____

Phone: _____

Email: _____

Additional Information

Notes: _____

Current Wheelchair: _____

Customer Weight: _____

Customer Height: _____

Customer Disability: _____

Other

VAT Exemption Declaration (UK Only):
I declare that I am chronically sick or disabled by reason of:

and that I am receiving from RGK Wheelchairs Ltd, the wheelchair specified herein and I claim relief from Value Added Tax under group 12 of schedule 8 to Value Added Tax Act 1994.
Signature: _____ Date: _____

RGK Contact Authorisation:
From time to time, RGK would like to send you exclusive information, news and offers on everything RGK, by email or post. We will not pass any of your details to any third party.
I would like to be contacted by RGK:
Signature: _____ Date: _____

SERIAL NO: _____

Guide:

- Base product
- Required option
- Optional Extra
- Critical Information
- Information Needed

PRODUCT STYLE

TMLXZ010 MAXLITE
£3,423.00

XA080 Closed design

Max User Weight 100kg (220lbs)



PLEASE NOTE: ALL RGK CHAIRS ARE HAND BUILT AND HAVE A MANUFACTURING MEASUREMENT TOLERANCE OF +/- 5MM

CAD APPROVAL

XW009 QUOTE ONLY (NO CAD FOR APPROVAL)
£0.00

XW011 ORDER (NO CAD FOR APPROVAL)
£0.00

XW012 QUOTE CAD drawing for approval
£312.00 (2 customer amendments ONLY)

XW010 ORDER CAD drawing for approval
£192.00 (2 customer amendments ONLY)

KEY MEASUREMENTS

XY010 Seat width (*Inside of sideguards*)

 mm

(Max - 440mm)
(Min - 250mm)

XY020 Seat length

 mm

(Max - 440mm)
(Min - 250mm)

XY030 Extra seat length (*Provides additional leg support & hand grip*)

 mm

XY050 Front frame height

 mm

(Max - 550mm)
(Min - 380mm)

XY060 Rear frame height

 mm

(Max - 550mm)
(Min - 360mm)

XY070 Frame length

 mm

(Max - 650mm)
(Min XY020 + XY030 + 110mm)

XY072 Castor position

 mm

Optimise measurements

XA020 Frame ergonomic seat
£59.00



Specify length
 mm

(Standard = 120mm)

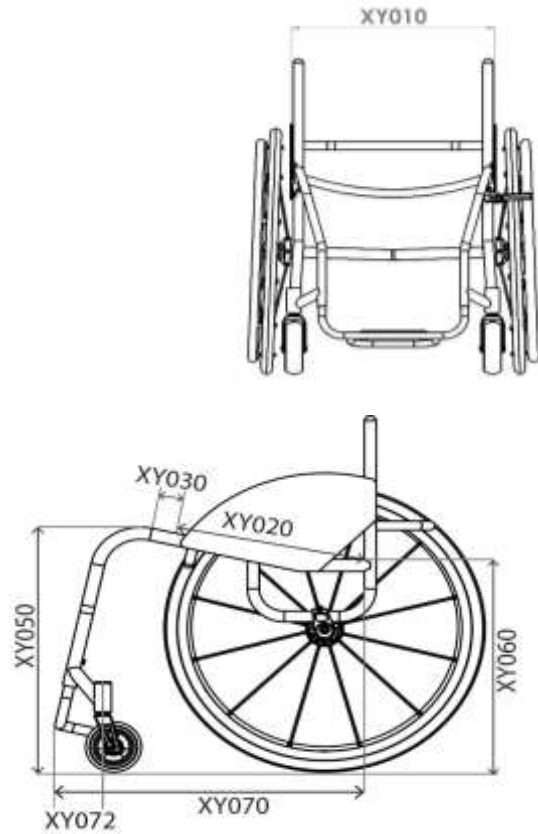

FRONT FRAME AND FOOTREST

Front Frame Options

XY080 Seat taper design

i Specify width mm

(When combined with XY091, dimension is inbetween the centre of the main bends)

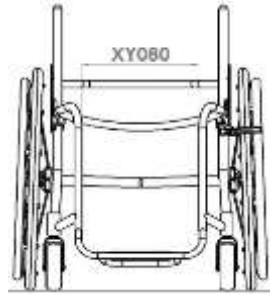

XY091 Parallel taper design

i Specify width mm

(When combined with XY080, Dimensions must be smaller)

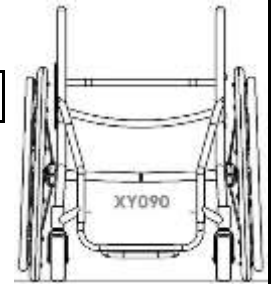

Footrest Design (Choose One)

XY100 Round design

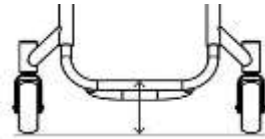

XY105 Square design

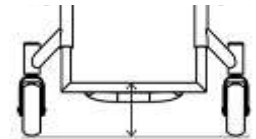

XB200 High level footrest (Only with XB010, XB080 & XB150)
£104.00

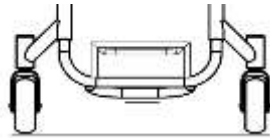

XB200 High level footrest (Only with XB010, XB080 & XB150)
£104.00

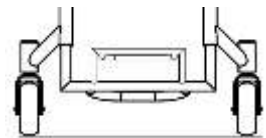

Footrest Individual Measurements

XY115 Front footrest height

! mm

XY120 Rear footrest height

i mm (Std = 20 lower than front height)

XY125 Footrest length

i mm (Std = 100mm) (160mm and over requires heavy duty upgrade XB150)

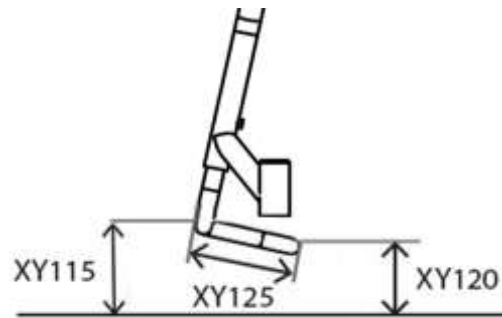

Footrest Style

XB020 Tubular titanium footrest (Height adjustable)

XB030 Flip up plastic footrest (Angle/height adjustable)
£198.00

XB070 Angle adjust aluminium footrest (Angle/height adjustable)
£83.00

XB150 Heavy duty tubular footrest (Height adjustable)
£104.00

TMLXB080 Tubular footrest welded into frame (No height adjustment)
£93.00

Footrest Cover

XB050 Carbon fibre cover (Not XB070 & XB030)
£98.00

XB170 Aluminium cover (Not XB070 & XB030)
£50.00

XB040 Plastic Cover (Not XB070 & XB030)
£50.00

XB165 Rubber grip tape (not with XB030) (3M Safety walk)
£27.00

CASTOR WHEELS, FORKS & WHEEL LOCKS

Castor Wheels 100mm (4")

- XC060 Soft roll 4"x1.3"
(Black only)
- XC110 Aluminium centre 4"x1"
£94.00 *(Silver hub and black urethane tyre only)*
- XC130 Aluminium centre 4"x1.4"
£94.00 *(choose colour below)*



- | | | |
|--|---|--|
| <input type="checkbox"/> Silver hub & black tyre | <input type="checkbox"/> Gold hub & black tyre | <input type="checkbox"/> Purple hub & black tyre |
| <input type="checkbox"/> Black hub & black tyre | <input type="checkbox"/> Green hub & black tyre | |
| <input type="checkbox"/> Red hub & black tyre | <input type="checkbox"/> Blue hub & black tyre | |

125mm (5")

- | | |
|---|--|
| <input type="checkbox"/> XC070 Soft roll 5"x1.3"
<i>(Black only)</i> | <input type="checkbox"/> XC120 Aluminium centre 5"x1"
£94.00 <i>(Silver hub and black urethane tyre only)</i> |
| <input type="checkbox"/> XC100 Pneumatic Aluminium centre 5"x1"
£105.00 <i>(Grey only)</i> | <input type="checkbox"/> XC140 Aluminium centre 5"x1.4"
£94.00 <i>(Silver hub and black urethane tyre only)</i> |

150mm (6")

- | | |
|--|--|
| <input type="checkbox"/> XC080 Soft roll 6"x1.3" | <input type="checkbox"/> XC145 Aluminium centre 6"x1.4"
£94.00 <i>(Silver hub and black urethane tyre only)</i> |
|--|--|

Castor Forks

- | | | |
|--|---|---|
| <input type="checkbox"/> XC190 Performance castor fork | <i>(Standard when no option selected)</i> | <input type="checkbox"/> XC210 Froglegs suspension castor fork
£342.00 |
| <input type="checkbox"/> XC192 High trail castor fork | <i>Note: Greater distance between contact patch and steering axis reduces flutter at higher speeds. Colour follows the accent</i> | <input type="checkbox"/> Black <input type="checkbox"/> Silver |

Castor Pin Width

- XY330 Castor pin width
- mm
- Optimise measurements
(Minimum width for clear castor rotation and maximum wheelbase length)

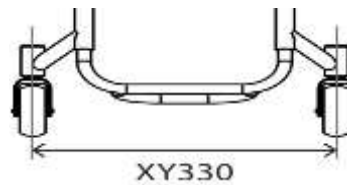

Wheel Lock Options

- | | |
|---|---|
| <input type="checkbox"/> XD020 Underseat Scissor | <input type="checkbox"/> XD050 Push to lock |
| <input type="checkbox"/> XD030 Compact scissor
£74.00 | <input type="checkbox"/> XD046 Out Front push to lock
£127.00 |
| <input type="checkbox"/> XD035 Compact scissor with lightweight fixing
£87.00 <i>(Only with fixed centre of gravity)</i> | <input type="checkbox"/> XD085 Eagle wheel locks (Indicate colour)
£160.00 |
| <input type="checkbox"/> XD010 Omit wheel locks | <input type="checkbox"/> XD086 Eagle WL with L/W fixing (Indicate colour)
£174.00 <i>(Only with fixed centre of gravity)</i> |
- BLACK
 PURPLE
 RED
 BLUE
- Black Std if no option selected**

SIDEGUARDS AND ARMRESTS

Sideguard

Aluminium Options

- XE030 Screw on aluminium
£130.00
- XE080 Lift out aluminium
£300.00
- XE180 Flip back aluminium
£156.00

Carbon Fibre Options

- XE050 Screw on carbon fibre
£291.00
- XE100 Lift out carbon fibre
£406.00
- XE200 Flip back carbon fibre
£315.00

ABS Plastic Options



- XE070 Screw on ABS plastic
£130.00
- XE120 Lift out ABS plastic
£194.00

Welded Options

- TMLXE220 Welded with 6mm bead
£277.00

Sideguard Measurements

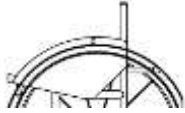
Optimised measurements

- 25mm above tyre (*Follow tyre*) 
- Individual above tyre (*Follow tyre*) 
- Level with tyre (*Follow tyre*) 

Individual measurements

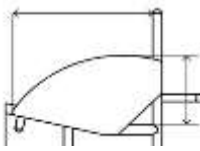
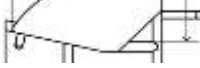
- Sideguard length 
- Sideguard height 

Sideguard with Fender

Aluminium Options



- XE040 Screw on aluminium with fender
£156.00
- XE090 Lift out aluminium with fender
£325.00
- XE190 Flip back aluminium with fender
£181.00

Carbon Fibre Options

- XE060 Screw on carbon fibre with fender
£382.00
- XE110 Lift out carbon fibre with fender
£473.00
- XE210 Flip back carbon fibre with fender
£382.00

Sideguard Measurements

Fender height

- 10mm above tyre
(*Standard*)
 - Individual above tyre
(*Min = 10mm*)
-  

Fender position

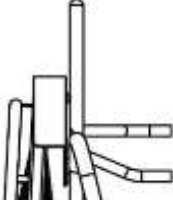
- Centre of tyre
(*Standard if no option selected*) 
- Outside of tyre 

Armrest Options

- XF010 Lift out armrest with plastic sideguard
£334.00 (*Indicate fixed height*)
- XF020 Lift out armrest with Aluminium sideguard
£334.00 (*Indicate fixed height*)

Height (*Top of seatrail to top of armrest*)

-  mm

BACKREST

Backrest Height

XY230 Backrest height fixed

i Specify height
 mm

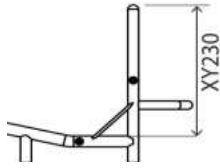

XY245 Backrest height adjustable
 £98.00 (+/-25mm)

i Specify height
 mm

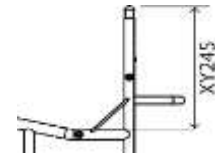

Backrest Design

XG010 Fixed backrest (Non-folding)

TMLXG020 Folding backrest with 2 position snap lock and angle adjust (± 5 Deg)

Ergonomic Options

XY360 Backrest angle

i -5 -3 0 +3 +5
 Individual Deg
 (Max -10/+20 Deg)

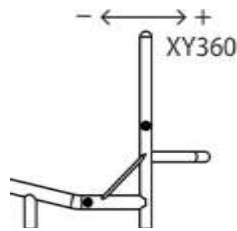

XG100 Ergonomic backrest
 £59.00

i Vertical height
 mm

i Rearward position
 mm



XG110 Inward taper
 £59.00 (inside of backrest posts)

i Specify width or per side
 mm

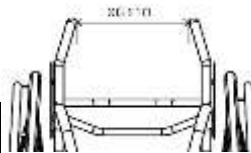

XG120 Outward flare
 £59.00 (inside of backrest posts)

i Specify width or per side
 mm

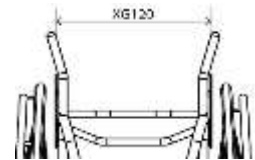

Push handle Options

XG070 Screw in push handles
 £115.00 (N/A with XY245)

XG080 Flip down push handles
 £176.00 (N/A with XY245)

XG085 Flip down push handles height adjustable
 £194.00 (N/A with XY245)

XG090 Stroller push handles height adjustable
 £203.00

i Height from floor mm Optimise (1000mm from floor)

XG097 Integrated push handle
 £194.00 (Quickie design)

Backrest Options

XG040 Heavy duty backrest upgrade
 £105.00 (Recommended for hand cycling) (Not with XY245)

XG130 Extra deep brace bar
 £59.00 (Recommended for JAY backs) (Std - 90mm)

i Depth mm

CAMBER BAR

Adjustable Centre of Gravity

- XH110 Square back adjustable centre of gravity
(25-150mm)
(Open or closed frame)

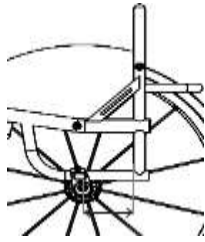

- XH120 Round back adjustable centre of gravity
(60-150mm)
(Open or closed frame)

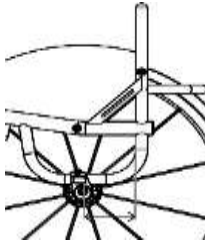
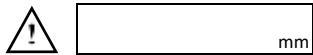

- TMLXH090 V-style fixed centre of gravity
£245.00
(25-125mm)
(Open or closed frame)

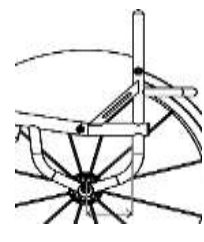

Specify Camber Angle

- XY390 Camber angle

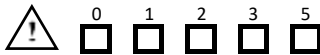

- XY390 Camber angle



Camber Bar Options

- XH030 Frog Legs suspension camber bar
£494.00

- XH040 Handbike camber bar fixed
£206.00

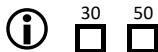
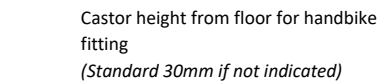
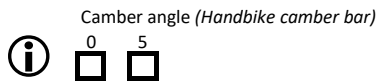

- XH040 Handbike camber bar fixed
£206.00

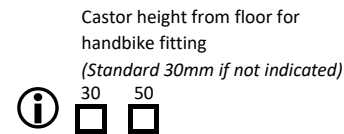
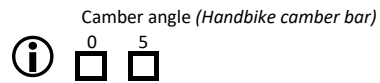

Anti-Tip Options

- XJ010 Swingaway anti tip LEFT side (Only with square back frame. Not with XH040)
£105.00

- XJ020 Swingaway anti tip RIGHT side (Only with square back frame. Not with XH040)
£105.00

- XJ100 Single sport anti tip (centre mounted)
£325.00

REAR WHEELS			
Rear Wheel Size			
<input type="checkbox"/> XY420 24" Wheels	<input type="checkbox"/> XY430 25" Wheels		
Rear Wheel Gap			
<input checked="" type="checkbox"/> XY460 Rear wheel gap <div style="display: flex; justify-content: space-around; align-items: center;"> <div style="text-align: center;"> <input type="checkbox"/> 15 </div> <div style="text-align: center;"> <input type="checkbox"/> 20 </div> <div style="text-align: center;"> <input type="checkbox"/> 25 </div> </div> <div style="margin-left: 20px;"> </div>			
Individual <input style="width: 100px;" type="text"/> mm			
Wheel Options (Choose one)			
<input type="checkbox"/> XK010 Fusion 16 spoke <i>(Silver Hub, black spokes)</i>	<input type="checkbox"/> XK320 Spinergy XLX 12 spoke £585.00		
<input type="checkbox"/> XK050 Spinergy LX 12 spoke £555.00	<input type="checkbox"/> XK060 Spinergy SPOX 18 spoke £418.00		
<input type="checkbox"/> XK150 Spinergy CLX 18 carbon blade spoke £1,104.00 <i>N/A IN SILVER HUB</i>	<input type="checkbox"/> XK070 Spinergy BLXL 18 blade spoke £585.00 <i>N/A IN SILVER HUB</i>		
Spinergy Colour Options:			
<input type="checkbox"/> Black spokes	<input type="checkbox"/> White spokes	<input type="checkbox"/> Yellow spokes	<input type="checkbox"/> XK180 Individual spoke design £130.00 <i>(Specify colour)</i> Inside: _____ Outside: _____
<input type="checkbox"/> Red spokes	<input type="checkbox"/> Blue spokes	<input type="checkbox"/> Pink spokes	
<input type="checkbox"/> Purple spokes	<input type="checkbox"/> Orange spokes	<input type="checkbox"/> Green spokes	
Spinergy Anodise Options			
<input type="checkbox"/> XK190 Black hub <i>(std option)</i>	<input type="checkbox"/> XK200 Silver hub £68.00 <i>(n/a with BLXL/CLX)</i>	<input type="checkbox"/> XK201 Red hub/ribs £203.00 <i>(LX, XLX & BLXL only)</i>	<input type="checkbox"/> XK205 Individual hub/ribs £234.00 Select colour:
<input type="checkbox"/> XK202 Purple hub/ribs £203.00 <i>(LX, XLX & BLXL only)</i>	<input type="checkbox"/> XK203 Blue hub/ribs £203.00 <i>(LX, XLX & BLXL only)</i>	<input type="checkbox"/> XK204 Gold hub/ribs £203.00 <i>(LX, XLX & BLXL only)</i>	
Supply Without Wheels			
<input type="checkbox"/> XK040 Supply without Wheels -£136.00	<input type="checkbox"/> Wheel Type: <input style="width: 150px;" type="text"/> Tyre Type: <input style="width: 150px;" type="text"/>		
Handrim Position / Options			
<input type="checkbox"/> XY480 Narrow set handrim	<input type="checkbox"/> XY485 Wide set handrim		
<input type="checkbox"/> XL090 Remove excess mounting tabs £75.00 <i>(recommended for small wheel gaps)</i>			
Handrim Styles			
<input type="checkbox"/> XL010 Aluminium hard anodised 6 tab	<input type="checkbox"/> XL040 Titanium 6 tab £178.00		
<input type="checkbox"/> XL160 Elipse 6 tab £250.00 <i>(replacement for Surge)</i>	<input type="checkbox"/> XL035 Natural Fit LT £223.00		
<input type="checkbox"/> XL020 Tetra grip 6 tab £210.00	<input type="checkbox"/> XL150 Carbolife Gekko £442.00	<input type="checkbox"/> Black	<input type="checkbox"/> Silver
<input type="checkbox"/> XL100 Para grip 6 tab £210.00	<input type="checkbox"/> XL170 Carbolife Curve L (Black) £473.00		
Tyre Options			
<input type="checkbox"/> XM010 Kenda <input type="checkbox"/> Grey <input type="checkbox"/> Blue <input type="checkbox"/> Red <i>(Std)</i>	<input type="checkbox"/> XM060 Schwalbe One £70.00 <i>(24", 25" only)</i>		
<input type="checkbox"/> XM130 Kenda black £26.00	<input type="checkbox"/> XM050 Kenda K885 mountain bike tyre £20.00 <i>(24", 25" only)</i>		
<input type="checkbox"/> XM020 Schwalbe Marathon Plus £50.00			
<input type="checkbox"/> XM040 Shox solid airless (Black) £83.00			
Inner Tube Valve Options			
<input type="checkbox"/> XY500 Schraeder inner tube valve <i>(Standard if no option selected)</i>	<input type="checkbox"/> XY490 Presta inner tube valve		
Wheel Accessories			
<input type="checkbox"/> XK220 Titanium 130mm quick release axle pins (pair) £84.00 <i>(N/A with XK010 & XK070)</i>	<input type="checkbox"/> XK300 Offroad wheel set 22" rim with handrim, MTB tyre and axle pins £478.00 <i>(Replaces 24" wheel with XM010)</i>		
<input type="checkbox"/> XK240 Quad release axle nuts (pair) £115.00	<input type="checkbox"/> XK310 Offroad wheel set 24" rim with handrim, MTB tyre and axle pins £478.00 <i>(Replaces 25" wheel with XM010)</i>		

FINISH OPTIONS

Frame & Component Finish

- XN010 Powder coated frame XN150 Powder coated components (Frame colour if not specified)

Frame Comp. **Gloss**

- Black gloss 103
- White gloss 100
- Grey gloss 132
- Cream gloss 135
- Red gloss 108
- Yellow gloss 120
- Forest green gloss 143
- Green gloss 107
- Dark blue gloss 151
- Royal blue gloss 154
- Blue gloss 174
- Duckegg blue gloss 141
- Pink gloss 188
- Orange gloss 180
- Purple gloss 157

Frame Comp. **Matt**

- Black matt 105
- White matt 101
- Grey matt 131
- Light grey matt 133
- Navy blue matt 152

Frame Comp. **Special**

- Chrome Mirror 300
- Sparkle silver 170
- Metallic black matt 104
- Metallic grey matt 130
- Black sandpaper 201
- Grey sandpaper 202
- White sandpaper 200

- XN200 Individual paint colour -State Colour/RAL code
£127.00

- Frame Comp

- TMLXN030 Bead blast frame
£176.00 (All parts black unless XN165 chosen)
- TMLXN050 Polished frame
£486.00 (All parts black unless XN170 chosen)

- XN165 Bead blast components
£97.00
- XN170 Polished components
£143.00

Accent Colour

Note: Accent colour includes, forks, castor caps, decals.

- Black accent Silver accent
- Red accent Blue accent
- Purple accent

- XN250 Individual Accent Colour
£127.00

UPHOLSTERY

Seat Upholstery

- XP040 Seat sling adjustable tension with straps XR050 Carbon fibre seat plate
£250.00

Backrest Upholstery

- XP050 Airtech backrest strap adjustable XP070 Backrest upgrade to leather corners (Black)
£89.00 (not with flip down push handles)

Backrest Stitching Options

- Silver Black Blue Individual:
- Red Orange Purple

RGK Logo Colour

- White (Std) Green Blue Individual:
- Red Orange Purple

Model Logo Colour

- White (Std) Green Blue Individual:
- Red Orange Purple

Backrest Accessories

- XP110 Backrest with zip pocket
£66.00 XP170 Individual backrest embroidery
£101.00 PLEASE COMPLETE PAGE 11

CUSHION

Cushion foam options

- XP080 Cushion foam
£62.00
(select density and size below)
- Soft (CMS040) Medium (CMS050)
- 50mm 75mm 100mm

Cushion Cover Upgrades

- XP085 Nylon cushion cover
(Black)
- XP090 Air Lite cushion cover
£48.00
(Black)
- XP100 Leather cushion cover
£157.00
(Black)

Jay Products - PLEASE SUPPLY JAY ORDER FORM

- JAY Cushion
(Price dependant on size / option) Jay Order form attached
- JAY Backrest
(Price dependant on size / option) Jay Order form attached
- JAY Whitmyer Headrest
(Price dependant on size / option) Jay Order form attached

FRAME OPTIONS

- XR060 Welded calf strap mounting loops
£75.00
(To locate calf strap on front frame)
- Specify height from floor
-
- Optimise measurements

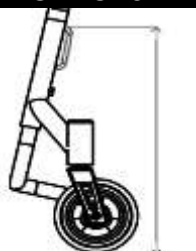

ACCESSORIES

- XR080 Frontwheel assembly
£539.00
(Only with Tubular style footrest)
- XP120 Frame protectors Neoprene zip fasten
£53.00
(Black)
- XP420 Frame protectors Nylon velcro fasten
£35.00
(Black)
- XR010 Seat pouch velcro attach
£28.00
(Black)
- XR200 Rucksack with RGK logo
£47.00
(Black)
- XR090 Tool kit
- XS060 Calf strap

DONATE / PART EXCHANGE

Donate your old chair for up to £250 off this order*

*Participating RGK resellers only. Any donation chair must include a functional frame and wheels. RGK will replace the upholstery and arrange delivery to a worthy cause.

Chair Make/Model: _____

Chair Serial/Ref No: _____

Agreed Value: _____

Part Exchange your old chair for up to £750 off this order*

*Participating RGK resellers only. Any Part Exchange chair must be less than 5 years old and include a functional frame, componentry and wheels.

Chair Make/Model: _____

Chair Serial/Ref No: _____

Agreed Value: _____

ADDITIONAL NOTES

INDIVIDUAL BACKREST EMBROIDERY

PLEASE PROVIDE JPEG IMAGE AT TIME OF ORDER AND NOTE POSITION BELOW



BRACE BAR

SPEC NOTES:

OFF SPEC REQUEST* *(please specify below the page number(s) and details to which the off spec request applies.*

OFF SPEC REQUEST APPROVED *(for internal RGK office only)*

X
RGK Internal Sign-off

Off spec requests require a feasibility study which may increase order price and lead time. Any dimension/ option/ frame request not listed on the order form will be treated as an off spec request.*