

SERIAL NO: _____



Customer Contact Details

Customer Name: _____

Advisor: _____

Address: _____

Phone: _____

Email: _____

Ship to Customer Address:

Shipping Name: _____

Shipping Address: _____

Phone: _____

Email: _____

Additional Information

Notes: _____

Current Wheelchair: _____

Customer Weight: _____

Customer Height: _____

Customer Disability: _____

Other

VAT Exemption Declaration (UK Only):
I declare that I am chronically sick or disabled by reason of:

and that I am receiving from RGK Wheelchairs Ltd, the wheelchair specified herein and I claim relief from Value Added Tax under group 12 of schedule 8 to Value Added Tax Act 1994.
Signature: _____ Date: _____

RGK Contact Authorisation:
From time to time, RGK would like to send you exclusive information, news and offers on everything RGK, by email or post. We will not pass any of your details to any third party.
I would like to be contacted by RGK:
Signature: _____ Date: _____

Guide:

Base product

Required option

Optional Extra



Critical Information



Information Needed



Non certified
Sub4 weight
option

PRODUCT STYLE

SBTX2010 OCTANE SUB4
£6,663.00

XA070 Open design

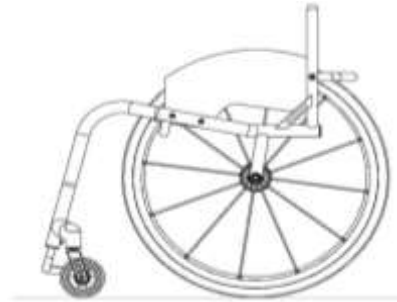

Max User Weight 110kg (242lbs)

PLEASE NOTE: ALL RGK CHAIRS ARE HAND BUILT AND HAVE A MANUFACTURING MEASUREMENT TOLERANCE OF +/- 5MM

CAD APPROVAL

XW010 ORDER CAD drawing for approval
£192.00 (2 customer amendments ONLY)

XW009 QUOTE ONLY (NO CAD FOR APPROVAL)
£0.00

XW012 QUOTE / CAD drawing for approval
£312.00 (2 customer amendments ONLY)

XW011 ORDER (NO CAD FOR APPROVAL)
£0.00

KEY MEASUREMENTS

XY010 Seat width (*Inside of sideguards*)

 mm

(Max - 440mm)
(Min - 250mm)

XY020 Seat length

 mm

(Max - 440mm)
(Min - 250mm)

XY030 Extra seat length (*Provides additional leg support & hand grip*)

 mm

(Max - 440mm total seat)

XY050 Front frame height

 mm

(Max - 520mm)
(Min - 380mm)

XY060 Rear frame height

 mm

(Max - 500mm)
(Min - 360mm)

XY070 Frame length

 mm

(Max - 625mm)
(Min = XY020 + XY030 + 140mm)

XY072 Castor position

 mm

Optimise measurements

XA020 Ergonomic seat
£59.00



Specify length

 mm

(Standard = 120mm)

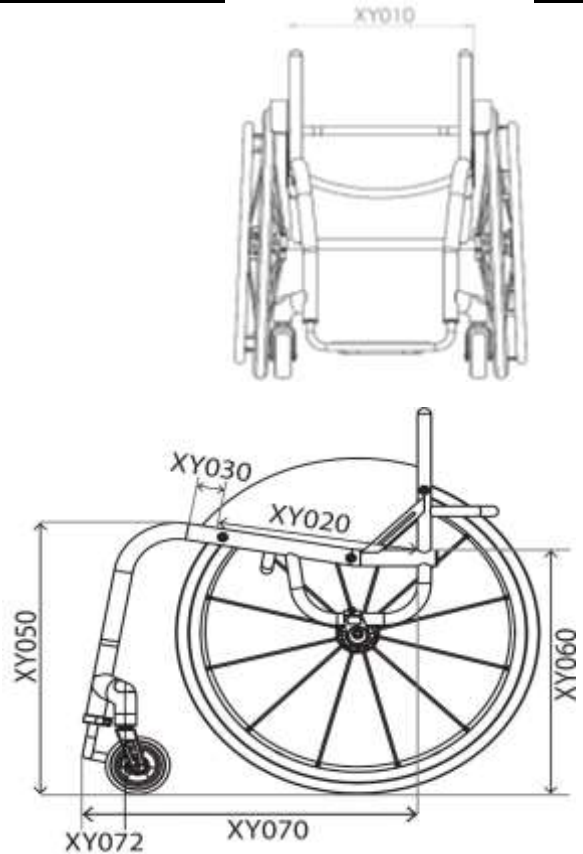

FRONT FRAME AND FOOTREST

Front Frame Options

XY080 Seat taper design

i Specify width mm

(When combined with XY091, dimension is inbetween the centre of the main bends)



XY091 Parallel taper design

i Specify width mm

(When combined with XY080, dimensions must be smaller by 20mm)

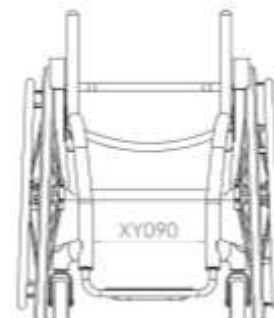

Footrest Design Choose One)

XY100 Round design

Castor Wheel Size	Max Height Achievable
4"	110mm

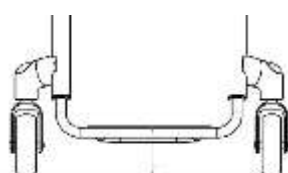

A XY105 Square design

Castor Wheel Size	Max Height Achievable
4"	130mm



Footrest Measurements

XY115 Front footrest height

! mm

XY120 Rear footrest height

i mm

Std = 20 lower than front height

XY125 Footrest length

i mm

Maximum length 140mm (Certified weight)
(160mm and over requires heavy duty upgrade XB150)

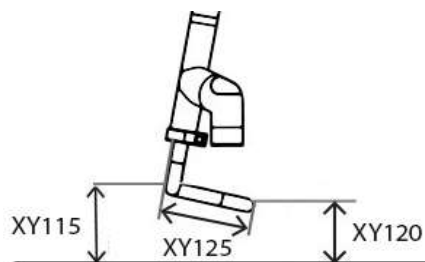

A XB200 High level footrest (Non-certified Sub4 option)
£104.00

Indicate front footrest height:
 mm

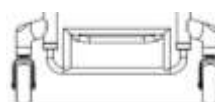

Footrest Style

XB025 Tubular Titanium footrest Sub4 (Height adjustable)

A XB020 Tubular titanium footrest (Height adjustable)
(Non Certified Sub4 option)

Footrest Cover

XB045 Lightweight carbon fibre cover
(With weight saving cut-out)

Footplate width Sub4 certified
(Std if no option selected)

A No Cut-Out
(Non Certified Sub4 option)

A Footplate width Standard (optimised plate width)
(Non Certified Sub4 option)

CASTOR WHEELS, FORKS & WHEEL LOCKS

Castor Wheels

XC135 Aluminium centre 4"x1.25"
Choose colour below:

- | | |
|--|---|
| <input type="checkbox"/> Silver hub & black tyre (Std) | <input type="checkbox"/> Green hub & black tyre |
| <input type="checkbox"/> Black hub & black tyre | <input type="checkbox"/> Red hub & black tyre |
| <input type="checkbox"/> Purple hub & black tyre | <input type="checkbox"/> Blue hub & black tyre |

SBTXC155 Forged carbon centre 4"x1.4" (Non certified Sub4 option)

XC140 Aluminium centre 5"x1.4" (Non certified Sub4 option)
£94.00 (Silver hub and black tyre only)

XC145 Aluminium centre 6"x1.4" (Non certified Sub4 option)
£94.00 (Silver hub and black tyre only)

Castor Forks

XC190 Performance castor fork (Std)
Note: Colour follows accent

XC192 High trail castor fork
Note: Greater distance between contact patch and steering axis reduces flutter at higher speeds. Colour follows accent

Castor Pin Width

XY330 Castor pin width
Optimise measurements (Minimum width for clear castor rotation and maximum wheelbase length)

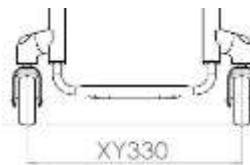

Wheel Lock Options

SBTXD036 Compact scissor with lightweight fixing

XD020 Underseat scissor (Non certified Sub4 option)

XD050 Push to lock (Non certified Sub4 option)

XD010 Omit wheel locks

SBTXD085 Eagle wheel locks (Indicate colour) (Non Certified Sub4 option)
£73.00

SBTXD086 Eagle WL with L/W fixing (Indicate colour) (Only with fixed centre of gravity) (Non Certified Sub4 option)
£83.00

- | | | | |
|--------------------------------|---------------------------------|------------------------------|-------------------------------|
| <input type="checkbox"/> BLACK | <input type="checkbox"/> PURPLE | <input type="checkbox"/> RED | <input type="checkbox"/> BLUE |
|--------------------------------|---------------------------------|------------------------------|-------------------------------|

Black Std if no option selected

SIDEGUARDS

Sideguard

XE055 Screw on lightweight carbon fibre

Sideguard with Fender

XE065 Screw on lightweight carbon fibre w/fender

Sideguard Measurements

Individual above tyre (Follow tyre - max. 25mm)

mm

Level with tyre (Follow tyre)

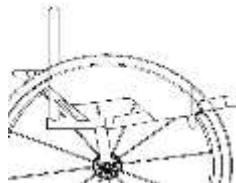

Sideguard Measurements

10mm above tyre (Standard)

Individual above tyre (Min = 10mm)

mm

Centre of tyre

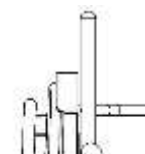
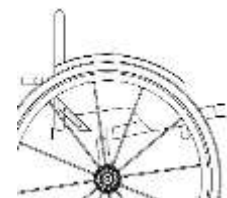

BACKREST

Backrest Measurements

XY230 Backrest height

Specify height
 mm



XG010 Fixed Backrest (non-folding)

SBTXG020 Folding backrest with 2 position snap lock and angle adjust **(Non certified Sub4 option)**
 £245.00

Ergonomic Options

XY360 Backrest angle

-5 -3 0 +3 +5
 Individual Deg
 (Max -10/+20 Deg)

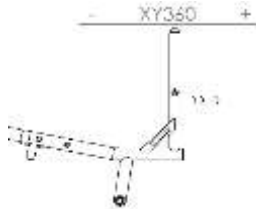

XG100 Ergonomic backrest
 £59.00

Vertical height
 mm

Rearward position
 mm

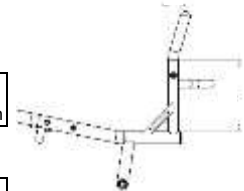

XG110 Inward taper
 £59.00
 (inside of backrest posts)

Specify width or per side
 mm

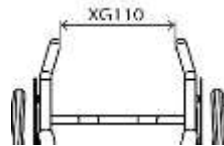

XG120 Outward flare
 £59.00
 (inside of backrest posts)

Specify width or per side
 mm



CAMBER BAR

Specify Camber Angle

XY390 Camber angle

! 1 2 3

Centre of Gravity

SBTXH100 Single post fixed centre of gravity
 (25-125mm)

mm



SBTXH130 Square back adjustable centre of gravity
 (25-125mm) **(Non Certified Sub4 option)**
 £272.00

mm

SBTXH140 Round back adjustable centre of gravity
 (60-125mm) **(Non Certified Sub4 option)**
 £272.00

mm

XG070 Screw in push handles
 £115.00 **(Non Certified Sub4 option)**

XG080 Flip down push handles
 £176.00 **(Non Certified Sub4 option)**

XJ100 Single sport anti tip
 £325.00 **(Non Certified Sub4 option)**

FRAME FINISH OPTIONS

Frame and Footrest (Choose One)

SBTXN030 Bead Blast frame



XN010 Powder coat frame

SBTXN050 Polished frame

Paint code

Accent Colour (Choose One)

Note: Accent colour includes, forks & castor caps.



Black accent

Silver accent

XN250

£127.00

Individual Accent Colour

Red accent

Blue accent

Purple accent

Carbon accent

(Castor caps only, black for rest)

UPHOLSTERY

Seat Upholstery

XP045 Sub4 Seat sling strap adjustable



XR050
£250.00

Carbon fibre seat plate
(Non certified Sub4 option)

Backrest Upholstery

XP035 Airtech Sub4 backrest strap adjustable



XP050

Airtech backrest strap adjustable
(Non certified Sub4 option)



XP070
£89.00

Backrest upgrade to leather corners (Black)
(only with Airtech upholstery XP050)
(Non certified Sub4 option)



XP110
£66.00

Backrest with zip pocket
(only with Airtech upholstery XP050)
(Non certified Sub4 option)



XP170
£101.00

Individual backrest embroidery
Please complete page 9
(only with Airtech upholstery XP050)

Backrest Upholstery Stitching Options

Silver

Black

Blue

Individual:

Red

Orange

Purple

RGK Logo Colour

White (Std)

Black

Blue

Individual:

Red

Orange

Purple

REAR WHEELS (* non certified weight options)	
Rear Wheel Size	
<input type="checkbox"/> XY420 24" Wheels	<input type="checkbox"/> XY430 25" Wheels
Rear Wheel Gap	
<input checked="" type="checkbox"/> XY460 Rear wheel gap <input type="checkbox"/> 15 <input type="checkbox"/> 20 <input type="checkbox"/> 25	
Rear Wheel Options	
<input type="checkbox"/> XK075 Spinergy BLXL 18 blade spoke <i>N/A IN SILVER HUB</i>	<input type="checkbox"/> SBTXK150 Spinergy CLX 18 carbon blade spoke £519.00 <i>N/A IN SILVER HUB</i>
<input checked="" type="checkbox"/> XK226 Titanium 100mm quick release axle pins	
Spinergy Colour Options:	
<input type="checkbox"/> Black spokes <input type="checkbox"/> White spokes <input type="checkbox"/> Yellow spokes <input type="checkbox"/> Red spokes <input type="checkbox"/> Blue spokes <input type="checkbox"/> Pink spokes <input type="checkbox"/> Purple spokes <input type="checkbox"/> Orange spokes <input type="checkbox"/> Green spokes	<input type="checkbox"/> XK180 Individual spoke design £130.00 <i>(Specify colour)</i> Inside: _____ Outside: _____
Spinergy Anodise Options	
<input type="checkbox"/> XK190 Black hub <i>(std option)</i>	<input type="checkbox"/> XK200 Silver hub £68.00 <i>(n/a with BLXL/CLX)</i>
<input type="checkbox"/> XK202 Purple hub/rims £203.00 <i>(LX, XLX & BLXL only)</i>	<input type="checkbox"/> XK201 Red hub/rims £203.00 <i>(LX, XLX & BLXL only)</i>
<input type="checkbox"/> XK203 Blue hub/rims £203.00 <i>(LX, XLX & BLXL only)</i>	<input type="checkbox"/> XK204 Gold hub/rims £203.00 <i>(LX, XLX & BLXL only)</i>
<input type="checkbox"/> XK205 Individual hub/rims £234.00 Select colour: _____	
Supply Without Wheels	
<input type="checkbox"/> SBTXK040 Supply without Wheels -£350.00	<div style="display: flex; justify-content: space-between; margin-top: 5px;"> <div style="border: 1px solid black; padding: 2px;">Wheel Type:</div> <div style="border: 1px solid black; padding: 2px;">Tyre Type:</div> </div>
Handrim Position / Options	
<input type="checkbox"/> XY480 Narrow set handrim	<input type="checkbox"/> XY485 Wide set handrim
<input type="checkbox"/> XL090 Remove excess mounting tabs £75.00 <i>(recommended for small wheel gaps)</i>	
Handrim Styles	
<input type="checkbox"/> XL010 Aluminium hard anodised 6 tab <i>(Standard if no option selected)</i>	<input type="checkbox"/> XL040 Titanium 6 tab £178.00
<input type="checkbox"/> XL160 Elipse 6 tab £250.00 <i>(replacement for Surge)</i>	<input type="checkbox"/> XL035 Natural Fit LT £223.00
<input type="checkbox"/> XL020 Tetra grip 6 tab £210.00	<input type="checkbox"/> XL150 Carbolife Gekko <input type="checkbox"/> Black <input type="checkbox"/> Silver £442.00
<input type="checkbox"/> XL100 Para grip 6 tab £210.00	<input type="checkbox"/> XL170 Carbolife Curve L (Black) £473.00
Tyre Options	
<input type="checkbox"/> XM060 Schwalbe One (Lightest option) £70.00	<input type="checkbox"/> XM130 Kenda black £26.00
<input type="checkbox"/> XM010 Kenda <input type="checkbox"/> Grey <input type="checkbox"/> Blue <input type="checkbox"/> Red	<input type="checkbox"/> XM050 Kenda K885 mountain bike tyre (24",25" only) £20.00 <i>(24",25" only)</i>
<input type="checkbox"/> XM020 Schwalbe Marathon Plus £50.00	
<input type="checkbox"/> XM040 Shox solid airless £83.00	
Inner Tube Valve Options	
<input type="checkbox"/> XY500 Schraeder inner tube valve <i>(Standard if no option selected)</i>	<input type="checkbox"/> XY490 Presta inner tube valve

* Indicates items that are not part of the certified weight of the Tiga Sub4

CUSHION (** non certified weight options)	
Cushion foam options	
<input type="checkbox"/> XP080 £62.00	Cushion foam <i>(select density and size below)</i>
<input type="checkbox"/> Soft (CMS040)	<input type="checkbox"/> Medium (CMS050)
<input type="checkbox"/> 50mm	<input type="checkbox"/> 75mm
	<input type="checkbox"/> 100mm
Cushion cover upgrades	
<input type="checkbox"/> XP085	Nylon cushion cover <i>(Black)</i>
<input type="checkbox"/> XP090 £48.00	Airlite cushion cover <i>(Black)</i>
<input type="checkbox"/> XP100 £157.00	Leather cushion cover <i>(Black)</i>
Jay Products - PLEASE PROVIDE JAY ORDER FORM	
<input type="checkbox"/> JAY Cushion <i>(Price dependant on size / option)</i>	<input type="text" value="Refer to Jay Order Form"/>
<input type="checkbox"/> JAY Backrest <i>(Price dependant on size / option)</i>	<input type="text" value="Refer to Jay Order Form"/>
<input type="checkbox"/> JAY Whitmyer Headrest <i>(Price dependant on size / option)</i>	<input type="text" value="Refer to Jay Order Form"/>
FRAME OPTIONS (** non certified weight options)	
<input type="checkbox"/> XR060 £75.00	Welded calf strap mounting loops <i>(To locate calf strap on front frame)</i>
	Specify height from floor <input type="text"/>
<input type="checkbox"/> <i>Optimise measurements</i>	
ACCESSORIES (** non certified weight options)	
<input type="checkbox"/> XR080 £539.00	Frontwheel assembly <i>(Only with XB010, TGAXB080, XB150)</i>
<input type="checkbox"/> XP120 £53.00	Frame protectors Neoprene zip fasten (Black)
<input type="checkbox"/> XP420 £35.00	Frame protectors Nylon velcro fasten (Black)
<input type="checkbox"/> XR010 £28.00	Seat pouch velcro attach <i>(Black)</i>
<input type="checkbox"/> XR200 £47.00	Rucksack with RGK logo (Black)
<input checked="" type="checkbox"/> XR090	Tool kit
<input checked="" type="checkbox"/> XS065	Sub4 Calf Strap
** indicates options that, when chosen, will not enable RGK to guarantee a Sub4kg product weight	

DONATE / PART EXCHANGE

Donate your old chair for up to £250 off this order*

*Participating RGK resellers only. Any donation chair must include a functional frame and wheels. RGK will replace the upholstery and arrange delivery to a worthy cause.

Chair Make/Model: _____

Chair Serial/Ref No: _____

Agreed Value: _____

Part Exchange your old chair for up to £750 off this order*

*Participating RGK resellers only. Any Part Exchange chair must be less than 5 years old and include a functional frame, componentry and wheels.

Chair Make/Model: _____

Chair Serial/Ref No: _____

Agreed Value: _____

ADDITIONAL NOTES

INDIVIDUAL BACKREST EMBROIDERY

PLEASE PROVIDE JPEG IMAGE AT TIME OF ORDER AND NOTE POSITION BELOW



BRACE BAR

SPEC NOTES:

OFF SPEC REQUEST* *(please specify below the page number(s) and details to which the off spec request applies.*

OFF SPEC REQUEST APPROVED *(for internal RGK office only)*

x
RGK Internal Sign-off

Off spec requests require a feasibility study which may increase order price and lead time. Any dimension/ option/ frame request not listed on the order form will be treated as an off spec request.*