

AI

ALUMINIUM 7020



CE

Customer Contact Details

Customer Name: _____

Advisor: _____

Address: _____

Phone: _____

Email: _____

Ship to Customer Address:

Shipping Name: _____

Shipping Address: _____

Phone: _____

Email: _____

Additional Information

Notes: _____

Current Wheelchair: _____

Customer Weight: _____

Customer Height: _____

Customer Disability: _____

Other**VAT Exemption Declaration (UK Only):**

I declare that I am chronically sick or disabled by reason of:

and that I am receiving from RGK Wheelchairs Ltd, the wheelchair specified herein and I claim relief from Value Added Tax under group 12 of schedule 8 to Value Added Tax Act 1994.

Signature: _____ Date: _____

RGK Contact Authorisation:

From time to time, RGK would like to send you exclusive information, news and offers on everything RGK, by email or post. We will not pass any of your details to any third party.

I would like to be contacted by RGK:

Signature: _____ Date: _____

Guide:

- Base product
- Required option
- Optional Extra
- Critical Information
- Information Needed

PRODUCT STYLE

TGAXZ010 TIGA
£3,423.00

- XA070 Open design
- XA080 Closed design
- TGAXA085 Crash tested upgrade
£130.00
- XA170 Heavy duty frame *(Spinergy SLX 24 spoke wheels also required)*

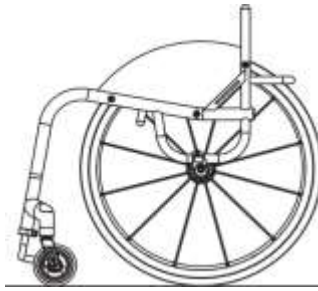

XA070 - Open design

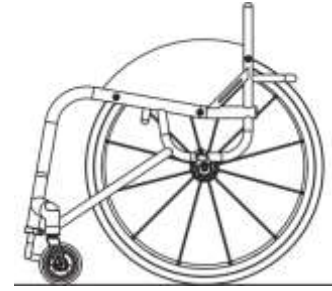

XA080 - Closed design

Max User Weight 125kg (275lbs)
Max User Weight XA170 Heavy Duty Frame 158kg (348lbs)

PLEASE NOTE: ALL RGK CHAIRS ARE HAND BUILT AND HAVE A MANUFACTURING MEASUREMENT TOLERANCE OF +/- 5MM

CAD APPROVAL

- XW009 QUOTE ONLY (NO CAD FOR APPROVAL)
£0.00
- XW011 ORDER (NO CAD FOR APPROVAL)
£0.00
- XW012 QUOTE / CAD drawing for approval
£312.00 (2 customer amendments ONLY)
- XW010 ORDER CAD drawing for approval
£192.00 (2 customer amendments ONLY)

KEY MEASUREMENTS

- XY010 Seat width *(Inside to inside of sideguards)*
 mm *(Max - 500mm)*
- XY020 Seat length
 mm *(Max - 500mm)*
- XY030 Extra Seat Length *(Provides additional leg support & hand grip)*
 mm
- XY050 Front frame height
 mm *(Max - 550mm)
(Min - 380mm)*
- XY060 Rear frame height
 mm *(Max - 550mm)
(Min - 360mm)*
- XY070 Frame length
 mm *(Min = XY020 + XY030 + 140mm)*
- XY072 Castor position
 mm
 Optimise measurements TX Forward Castor Position
- XA020 Ergonomic seat
£59.00
Specify length
 mm *(Standard = 120mm)*

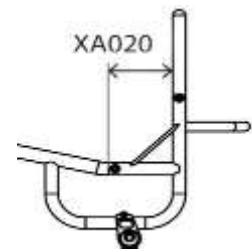
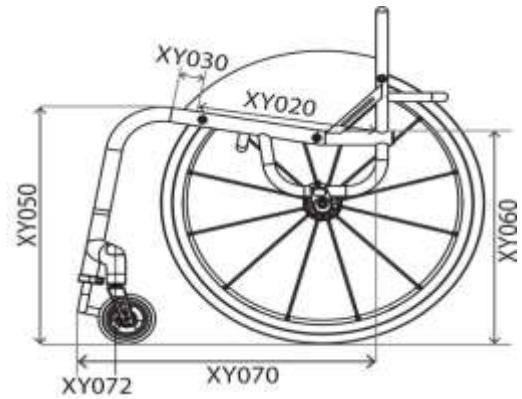
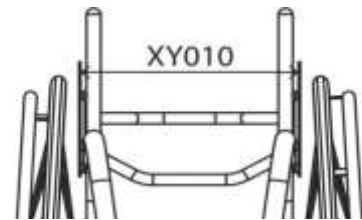

FRONT FRAME AND FOOTREST

Front Frame Options

- XY080 Seat taper design

i Specify width mm

(When combined with XY091, dimension is inbetween the centre of the main bends)

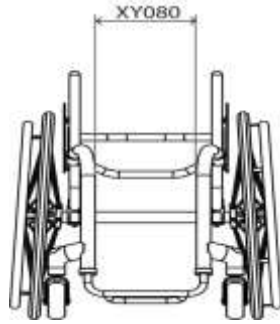

- XY091 Parallel taper design

i Specify width mm

(When combined with XY080, dimensions must be smaller by 20mm)

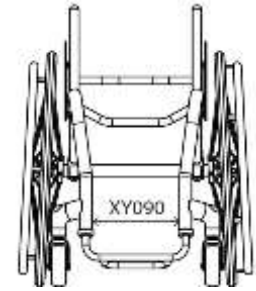

Footrest Design (Choose One)

- XY100 Round design

Castor Size	Max Height	With XB200
3"	115mm	165mm
4"	125mm	175mm
5"	135mm	185mm

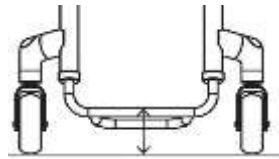

- XY105 Square design

Castor Size	Max Height	With XB200
3"	135mm	185mm
4"	145mm	195mm
5"	155mm	205mm

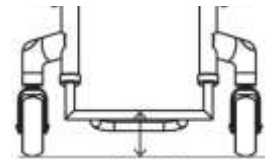

- XB200 High level footrest (Only with £104.00 XB010, XB080 & XB150)

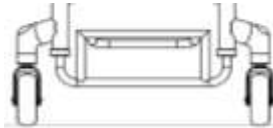

- XB200 High level footrest (Only with XB010, XB080 & XB150) £104.00

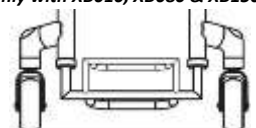

Footrest Individual Measurements

- XY115 Front footrest height

! mm

- XY120 Rear footrest height

i mm (Std = 20 lower than front height)

- XY125 Footrest length

i mm (Std = 100mm) (160mm and over requires heavy duty upgrade XB150)

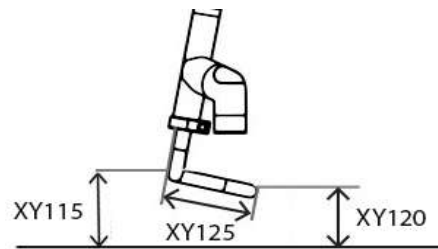

Footrest Style (Choose One)

- XB010 Tubular aluminium footrest (Height adjustable)

- XB030 Flip up plastic footrest £198.00 (Angle/height adjustable, with closed frame only)

- XB070 Angle adjustable aluminium footrest £83.00 (Angle/height adjustable)

- XB150 Heavy duty tubular footrest £104.00 (Height adjustable, for Freewheel use)

- TGAXB080 Tubular footrest welded into frame £93.00 (No height adjustment)

Footrest Cover

- XB050 Carbon fibre cover £98.00 (Not with XB070 & XB030)

- XB170 Aluminium cover £50.00 (Not with XB070 & XB030)

- XB040 Plastic Cover £50.00 (Not with XB070 & XB030)

- XB165 Rubber grip tape £27.00 (3M Safety walk) - (not with XB030)

CASTOR WHEELS, FORKS & WHEEL LOCKS

Castor Wheels 100mm (4")

- XC060 Soft roll 4"x1.3"
(Black only)
- XC110 Aluminium centre 4"x1"
£94.00 *(Silver hub and black urethane tyre only)*
- XC130 Aluminium centre 4"x1.4"
£94.00 *(choose colour below)*



- Silver hub & black tyre (Std)
- Gold hub & black tyre
- Purple hub & black tyre
- Black hub & black tyre
- Green hub & black tyre
- Red hub & black tyre
- Blue hub & black tyre

125mm (5")

- XC070 Soft roll 5"x1.3"
(Black only)
- XC120 Aluminium centre 5"x1"
£94.00 *(Silver hub and black urethane tyre only)*
- XC100 Pneumatic Aluminium centre 5"x1"
£105.00 *(Grey only)*
- XC140 Aluminium centre 5"x1.4"
£94.00 *(Silver hub and black urethane tyre only)*

150mm (6")

- XC080 Soft roll 6"x1.3"
(Black hub / grey tyre only)
- XC145 Aluminium centre 6"x1.4"
£94.00 *(Silver hub and black urethane tyre only)*

200mm (8")

- XC185 Pneumatic offroad 8"x2"
£94.00 *(only with TX Forward castor position)*

Castor Forks

- XC190 Performance castor fork
(Std when no option selected)
Note: Colour follows accent
- XC210 Froglegs suspension castor fork
£342.00
- XC192 High trail castor fork
Note: Greater distance between contact patch and steering axis reduces flutter at higher speeds. Colour follows accent



- Black
- Silver

Castor Pin Width

- XY330 Castor pin width
- mm
- Optimise measurements

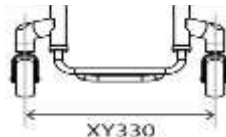

Wheel Lock Options (choose one)

- XD020 Underseat Scissor
 - XD050 Push to lock
 - XD030 Compact scissor
£74.00
 - XD046 Out Front push to lock
£127.00
 - XD035 Compact scissor with lightweight fixing
£87.00 *(Only with fixed centre of gravity)*
 - XD085 Eagle wheel locks (Indicate colour)
£160.00
 - XD086 Eagle WL with L/W fixing (Indicate colour)
£174.00 *(Only with fixed centre of gravity)*
- BLACK

PURPLE

RED

BLUE
- Black Std if no option selected**
- XD010 Omit wheel locks

SIDEGUARDS AND ARMRESTS

Sideguard Aluminium Options

- XE030 Screw on aluminium
£130.00
- XE080 Lift out aluminium
£300.00
- TGAXE130 Fold flat aluminium
£260.00
- XE180 Flip back aluminium
£156.00
- TGAXE220 Welded with 6mm bead
£198.00
- TGAXE230 Welded aluminium sport
(Extra strong)
£277.00

Carbon Fibre Options

- XE050 Screw on carbon fibre
£291.00
- XE100 Lift out carbon fibre
£406.00
- TGAXE150 Fold flat carbon fibre
£421.00
- XE200 Flip back carbon fibre
£315.00

ABS Plastic Options

- XE070 Screw on ABS plastic
£130.00
- XE120 Lift out ABS plastic
£194.00
- TGAXE170 Fold flat ABS plastic
£260.00

Sideguard Measurements Optimised measurements

- 25mm above tyre
(Follow tyre)
- Individual above tyre
(Follow tyre)
- mm
- Level with tyre
(Follow tyre)

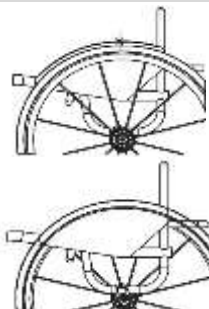

Individual measurements

- Sideguard length
- mm
- Sideguard height
- mm

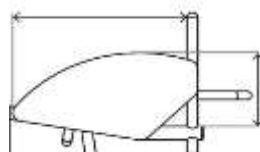

Sideguard with Fender Aluminium Options

- XE040 Screw on aluminium with fender
£156.00
- XE090 Lift out aluminium with fender
£325.00
- TGAXE140 Fold flat aluminium with fender
£285.00
- XE190 Flip back aluminium with fender
£181.00

Carbon Fibre Options

- XE060 Screw on carbon fibre with fender
£382.00
- XE110 Lift out carbon fibre with fender
£473.00
- TGAXE160 Fold flat carbon fibre with fender
£512.00
- XE210 Flip back carbon fibre with fender
£382.00

Sideguard Measurements Fender Height

- 10mm above tyre
(Standard)
- Individual above tyre
(Min = 10mm)
- mm

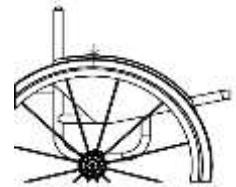

Fender position

- Centre of tyre
(Standard if no option selected)
- Outside of tyre

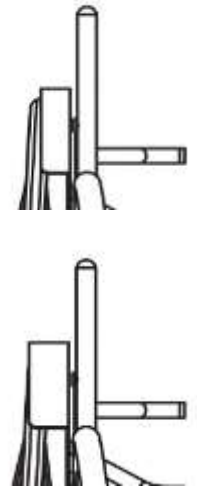

Armrest Options

- XF010 Lift out armrest with plastic sideguard
(Indicate fixed height)
£334.00
- XF020 Lift out armrest with Aluminium sideguard
(Indicate fixed height)
£334.00

- mm
Height (Top of seatrail to top of armrest)

BACKREST

Backrest Height

XY230 Fixed height backrest

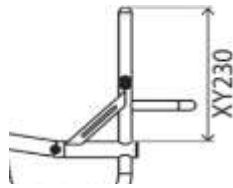

Specify height

 mm

XY245 Adjustable height backrest
£98.00 (+/-25mm)

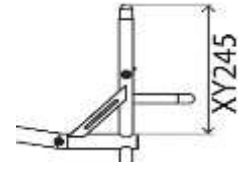

Specify height

 mm

Backrest Design

XG010 Fixed backrest
(Non-folding)

TGAXG020 Folding backrest
£245.00 (with 2 position snap lock and angle adjust ± 5 Deg)

Ergonomic Options

XY360 Backrest angle



-5 -3 0 +3 +5

Individual

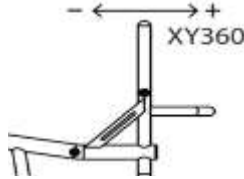
 mm
(Max -10/+20 Deg)

XG100 Ergonomic backrest
£59.00



Vertical height

 mm



Rearward position

 mm

XG110 Inward taper
£59.00 (inside of backrest posts)

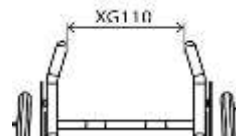

Specify width or per side

 mm

XG120 Outward flare
£59.00 (inside of backrest posts)

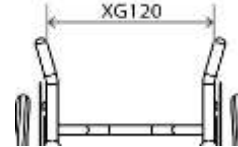

Specify width or per side

 mm

Push handle Options

XG070 Screw in push handles
£115.00 (N/A with XY245)

XG080 Flip down push handles
£176.00 (N/A with XY245)

XG085 Flip down push handles height adjustable
£194.00 (N/A with XY245)

XG090 Stroller push handles height adjustable
£203.00



Height from floor to top of handles

 mm

Optimise
(1000mm from floor)

XG097 Integrated push handle
£194.00 (Quickie design)

Backrest Options

XG040 Heavy duty backrest upgrade
£105.00 (Recommended for hand cycling) (Not with XY245)

XG130 Extra deep Square brace bar
£59.00 (Recommended for JAY backs) (Std - 90mm)



Depth

 mm

ILSA Backrest Options

XG140 Integrated lateral support
£308.00

A - Left

 mm

A - Right

 mm

B - Left

 mm

B - Right

 mm

C - Left

 mm

C - Right

 mm

D - Left

 mm

D - Right

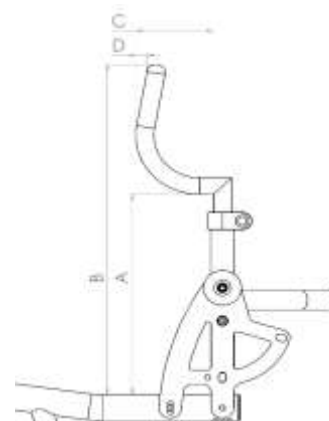
 mm

CAMBER BAR

Adjustable Centre of Gravity

- XH110 Square back adjustable centre of gravity (25-150mm)

Specify measurement mm

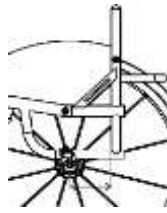

- XH120 Round back adjustable centre of gravity (60-150mm)

Specify measurement mm

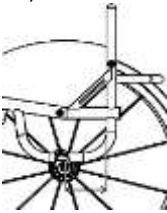

Fixed Centre of Gravity

- TGAXH100 Single post fixed centre of gravity (25-125mm) **£245.00**
(Open frame only)
(Not with Crash test option)

Specify measurement mm

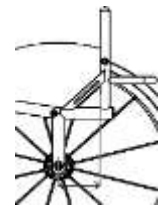

- TGAXH090 V-style fixed centre of gravity (25-125mm) **£245.00**

Specify measurement mm



Specify Camber Angle

- XY390 Camber angle
- 0 1 2 3 5

Specify Camber Angle

- XY390 Camber angle
- 0 1 2 3 5

Camber Bar Options

- XH040 Handbike camber bar fixed **£206.00**
- Camber angle (*Handbike camber bar*)
 0 5
- Castor height from floor for handbike fitting (*Standard 30mm if not indicated*)
 30 50

Camber Bar Options

- XH040 Handbike camber bar fixed **£206.00**
- Camber angle (*Handbike camber bar*)
 0 5
- Castor height from floor for handbike fitting (*Standard 30mm if not indicated*)
 30 50

- XH030 Froglegs suspension camber bar **£494.00**

Anti-Tip Options

- XJ010 Swingaway anti tip LEFT side (*Only with square back frame. Not with XH040*) **£105.00**
- XJ020 Swingaway anti tip RIGHT side (*Only with square back frame. Not with XH040*) **£105.00**

- XJ100 Single sport anti tip (centre mounted) **£325.00**

REAR WHEELS

Rear Wheel Size

- XY420 24" Wheels
 XY430 25" Wheels
 XY440 26" Wheels

Rear Wheel Gap

- XY460 Rear wheel gap



- 15
 20
 25

Individual mm

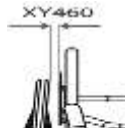

Rear Wheel Options

- | | |
|--|--|
| <input type="checkbox"/> XK010 Fusion 16 spoke
<i>(Silver Hub, black spokes)</i> | <input type="checkbox"/> XK320 Spinergy XLX 12 spoke
£585.00
<i>(cross/radial spoked)</i> |
| <input type="checkbox"/> XK050 Spinergy LX 12 spoke
£555.00 | <input type="checkbox"/> XK060 Spinergy SPOX 18 spoke
£418.00 |
| <input type="checkbox"/> XK150 Spinergy CLX 18 carbon blade spoke
£1,104.00
<i>N/A IN SILVER HUB</i> | <input type="checkbox"/> XK070 Spinergy BLXL 18 blade spoke
£585.00
<i>N/A IN SILVER HUB</i> |
| | <input type="checkbox"/> XK080 Spinergy SLX 24 spoke |

Spinergy Colour Options:

- | | | |
|--|--|--|
| <input type="checkbox"/> Black spokes | <input type="checkbox"/> White spokes | <input type="checkbox"/> Yellow spokes |
| <input type="checkbox"/> Red spokes | <input type="checkbox"/> Blue spokes | <input type="checkbox"/> Pink spokes |
| <input type="checkbox"/> Purple spokes | <input type="checkbox"/> Orange spokes | <input type="checkbox"/> Green spokes |

- XK180 Individual spoke design
£130.00
(Specify colour)
- Inside:
- Outside:

Spinergy Anodise Options

- | | | | |
|--|--|--|--|
| <input type="checkbox"/> XK190 Black hub
<i>(std option)</i> | <input type="checkbox"/> XK200 Silver hub
£68.00
<i>(N/A with BLXL/CLX)</i> | <input type="checkbox"/> XK201 Red hub/rims
£203.00
<i>(LX, XLX & BLXL only)</i> | <input type="checkbox"/> XK205 Individual:
£235.00 Select colour: <input style="width: 100px;" type="text"/> |
| <input type="checkbox"/> XK202 Purple hub/rims
£203.00
<i>(LX, XLX & BLXL only)</i> | <input type="checkbox"/> XK203 Blue hub/rims
£203.00
<i>(LX, XLX & BLXL only)</i> | <input type="checkbox"/> XK204 Gold hub/rims
£203.00
<i>(LX, XLX & BLXL only)</i> | |

Supply Without Wheels

- XK040 Supply without Wheels
-£136.00
- Wheel Type: Tyre Type:

Handrim Position / Options

- | | |
|--|---|
| <input type="checkbox"/> XY480 Narrow set handrim | <input type="checkbox"/> XY485 Wide set handrim |
| <input type="checkbox"/> XL090 Remove excess mounting tabs
£75.00
<i>(recommended for small wheel gaps)</i> | |

Handrim Styles

- | | |
|---|--|
| <input type="checkbox"/> XL010 Aluminium hard anodised 6 tab | <input type="checkbox"/> XL040 Titanium 6 tab
£178.00 |
| <input type="checkbox"/> XL160 Elipse 6 tab
£250.00
<i>(replacement for Surge)</i> | <input type="checkbox"/> XL035 Natural Fit LT
£223.00 |
| <input type="checkbox"/> XL020 Tetra grip 6 tab
£210.00 | <input type="checkbox"/> XL150 Carbolife Gekko
£442.00 |
| <input type="checkbox"/> XL100 Para grip 6 tab
£210.00 | <input type="checkbox"/> XL170 Carbolife Curve L (Black)
£473.00 |
- Black Silver

Tyre Options

- | | |
|---|---|
| <input type="checkbox"/> XM010 Kenda <input type="checkbox"/> Grey <input type="checkbox"/> Blue <input type="checkbox"/> Red
<i>(Std)</i> | <input type="checkbox"/> XM060 Schwalbe One
£70.00
<i>(24", 25" only)</i> |
| <input type="checkbox"/> XM130 Kenda black
£26.00 | <input type="checkbox"/> XM050 Kenda K885 mountain bike tyre
£20.00
<i>(24", 25" only)</i> |
| <input type="checkbox"/> XM020 Schwalbe Marathon Plus
£50.00 | |
| <input type="checkbox"/> XM040 Shox solid airless
£83.00
<i>(Black only)</i> | |

Inner Tube Valve Options

- | | |
|--|--|
| <input type="checkbox"/> XY500 Schraeder inner tube valve
<i>(Standard if no option selected)</i> | <input type="checkbox"/> XY490 Presta inner tube valve |
|--|--|

Wheel Accessories

- | | |
|--|---|
| <input type="checkbox"/> XK220 Titanium 130mm quick release axle pins (pair)
£84.00
<i>(N/A with XK010 & XK070)</i> | <input type="checkbox"/> XK300 Offroad wheel set 22" with handrim, MTB tyre and axle pins
£478.00
<i>(Replaces 24" wheel with XM010)</i> |
| <input type="checkbox"/> XK240 Quad release axle nuts (pair)
£115.00 | <input type="checkbox"/> XK310 Offroad wheel set 24" with handrim, MTB tyre and axle pins
£478.00
<i>(Replaces 25" wheel with XM010)</i> |

FINISH OPTIONS

Frame & Component Finish

- XN010 Powder coated frame XN150 Powder coated components (Frame colour if not specified)

Frame Comp. Gloss Frame Comp. Matt Frame Comp. Special

- | | | |
|--|---|---|
| <input type="checkbox"/> <input type="checkbox"/> Black gloss 103 | <input type="checkbox"/> <input type="checkbox"/> Black matt 105 | <input type="checkbox"/> <input type="checkbox"/> Chrome Mirror 300 |
| <input type="checkbox"/> <input type="checkbox"/> White gloss 100 | <input type="checkbox"/> <input type="checkbox"/> White matt 101 | <input type="checkbox"/> <input type="checkbox"/> Sparkle silver 170 |
| <input type="checkbox"/> <input type="checkbox"/> Grey gloss 132 | <input type="checkbox"/> <input type="checkbox"/> Grey matt 131 | <input type="checkbox"/> <input type="checkbox"/> Metallic black matt 104 |
| <input type="checkbox"/> <input type="checkbox"/> Cream gloss 135 | <input type="checkbox"/> <input type="checkbox"/> Light grey matt 133 | <input type="checkbox"/> <input type="checkbox"/> Metallic grey matt 130 |
| <input type="checkbox"/> <input type="checkbox"/> Red gloss 108 | <input type="checkbox"/> <input type="checkbox"/> Navy blue matt 152 | <input type="checkbox"/> <input type="checkbox"/> Black sandpaper 201 |
| <input type="checkbox"/> <input type="checkbox"/> Yellow gloss 120 | | <input type="checkbox"/> <input type="checkbox"/> Grey sandpaper 202 |
| <input type="checkbox"/> <input type="checkbox"/> Forest green gloss 143 | | <input type="checkbox"/> <input type="checkbox"/> White sandpaper 200 |
| <input type="checkbox"/> <input type="checkbox"/> Green gloss 107 | | |
| <input type="checkbox"/> <input type="checkbox"/> Dark blue gloss 151 | | |
| <input type="checkbox"/> <input type="checkbox"/> Royal blue gloss 154 | | |
| <input type="checkbox"/> <input type="checkbox"/> Blue gloss 174 | | |
| <input type="checkbox"/> <input type="checkbox"/> Duckegg blue gloss 141 | | |
| <input type="checkbox"/> <input type="checkbox"/> Pink gloss 188 | | |
| <input type="checkbox"/> <input type="checkbox"/> Orange gloss 180 | | |
| <input type="checkbox"/> <input type="checkbox"/> Purple gloss 157 | | |

- XN200 Individual paint colour (State Colour/RAL code)
£127.00

Frame Comp

-

- TGAXN030 Brushed frame
£176.00 (All parts black unless XN160 chosen)

- XN160 Brushed components
£97.00

- TGAXN050 Polished frame
£486.00 (All parts black unless XN170 chosen)

- XN170 Polished components
£143.00

Accent Colour

Note: Accent colour includes, forks, clamps & castor caps.

- | | | |
|--|--|--|
| <input type="checkbox"/> Black accent | <input type="checkbox"/> Silver accent | <input type="checkbox"/> XN250 Individual Accent Colour
£127.00 |
| <input type="checkbox"/> Red accent | <input type="checkbox"/> Blue accent | |
| <input type="checkbox"/> Purple accent | <input type="checkbox"/> Carbon accent
(Castor caps only, black for rest) | |

UPHOLSTERY

Seat Upholstery

- XP040 Seat sling adjustable tension with straps XR050 Carbon fibre seat plate
£250.00

Backrest Upholstery

- XP050 Airtech backrest strap adjustable XP070 Backrest upgrade to leather corners
£89.00 (Black)

Backrest Stitching Colour

- | | | | |
|---------------------------------|---------------------------------|---------------------------------|--------------------------------------|
| <input type="checkbox"/> Silver | <input type="checkbox"/> Black | <input type="checkbox"/> Blue | <input type="checkbox"/> Individual: |
| <input type="checkbox"/> Red | <input type="checkbox"/> Orange | <input type="checkbox"/> Purple | _____ |

RGK Logo Colour

- | | | | |
|--------------------------------------|---------------------------------|---------------------------------|--------------------------------------|
| <input type="checkbox"/> White (Std) | <input type="checkbox"/> Green | <input type="checkbox"/> Blue | <input type="checkbox"/> Individual: |
| <input type="checkbox"/> Red | <input type="checkbox"/> Orange | <input type="checkbox"/> Purple | _____ |

Model Logo Colour

- | | | | |
|--------------------------------------|---------------------------------|---------------------------------|--------------------------------------|
| <input type="checkbox"/> White (Std) | <input type="checkbox"/> Green | <input type="checkbox"/> Blue | <input type="checkbox"/> Individual: |
| <input type="checkbox"/> Red | <input type="checkbox"/> Orange | <input type="checkbox"/> Purple | _____ |

Backrest Accessories

- XP110 Backrest with zip pocket
£66.00 XP170 Individual backrest embroidery
£101.00 PLEASE COMPLETE PAGE 11

CUSHION

Cushion foam options

- XP080** Cushion foam
£62.00 *(select density and size below)*
- i** Soft (CMS040) Medium (CMS050)
- 50mm 75mm 100mm

Cushion Cover Upgrades

- XP085** Nylon cushion cover
(Black)
- XP090** Air Lite cushion cover
£48.00 *(Black)*
- XP100** Leather cushion cover
£157.00 *(Black)*

Jay Products - PLEASE PROVIDE JAY ORDER FORM

- JAY Cushion
(Price dependant on size / option) Jay Order form attached
- JAY Backrest
(Price dependant on size / option) Jay Order form attached
- JAY Whitmyer Headrest
(Price dependant on size / option) Jay Order form attached

FRAME OPTIONS

- XR060** Welded calf strap mounting loops
£75.00 *(To locate calf strap on front frame)*

Specify height from floor

- Optimise measurements



ACCESSORIES

- XR080** Frontwheel assembly
£539.00 *(Only with Tubular style footrest)*
- XP120** Frame protectors Neoprene zip fasten
£53.00 *(Black)*
- XP420** Frame protectors Nylon velcro fasten
£35.00 *(Black)*
- XR010** Seat pouch velcro attach
£28.00 *(Black)*
- XR200** Rucksack with RGK logo
£47.00 *(Black)*
- XR090** Tool kit
- XS060** Calf strap

DONATE / PART EXCHANGE

Donate your old chair for up to £250 off this order*

*Participating RGK resellers only. Any donation chair must include a functional frame and wheels. RGK will replace the upholstery and arrange delivery to a worthy cause.

Chair Make/Model: _____

Chair Serial/Ref No: _____

Agreed Value: _____

Part Exchange your old chair for up to £750 off this order*

*Participating RGK resellers only. Any Part Exchange chair must be less than 5 years old and include a functional frame, componentry and wheels.

Chair Make/Model: _____

Chair Serial/Ref No: _____

Agreed Value: _____

ADDITIONAL NOTES

INDIVIDUAL BACKREST EMBROIDERY

PLEASE PROVIDE JPEG IMAGE AT TIME OF ORDER AND NOTE POSITION BELOW



BRACE BAR

SPEC NOTES:

OFF SPEC REQUEST* *(please specify below the page number(s) and details to which the off spec request applies.*

OFF SPEC REQUEST APPROVED *(for internal RGK office only)*

x
RGK Internal Sign-off

Off spec requests require a feasibility study which may increase order price and lead time. Any dimension/ option/ frame request not listed on the order form will be treated as an off spec request.*