

SERIAL NO: _____

AI
ALUMINIUM 7020



CE

Customer Contact Details

Customer Name: _____

Advisor: _____

Address: _____

Phone: _____

Email: _____

Ship to Customer Address:

Shipping Name: _____

Shipping Address: _____

Phone: _____

Email: _____

Additional Information

Notes: _____

Current Wheelchair: _____

Customer Weight: _____

Customer Height: _____

Customer Disability: _____

Other

VAT Exemption Declaration (UK Only):
 I declare that I am chronically sick or disabled by reason of:

 and that I am receiving from RGK Wheelchairs Ltd, the wheelchair specified herein and I claim relief from Value Added Tax under group 12 of schedule 8 to Value Added Tax Act 1994.
 Signature: _____ Date: _____

RGK Contact Authorisation:
 From time to time, RGK would like to send you exclusive information, news and offers on everything RGK, by email or post. We will not pass any of your details to any third party.
 I would like to be contacted by RGK:
 Signature: _____ Date: _____

Guide:

Base product

Required option

Optional Extra



Critical Information



Information Needed



Non certified
Sub4 weight
option

PRODUCT STYLE

SBAXZ010 TIGA SUB4
£6,009.00

XA070 Open design

Max User Weight 110kg (242lbs)

PLEASE NOTE: ALL RGK CHAIRS ARE HAND BUILT AND HAVE A MANUFACTURING MEASUREMENT TOLERANCE OF +/- 5MM

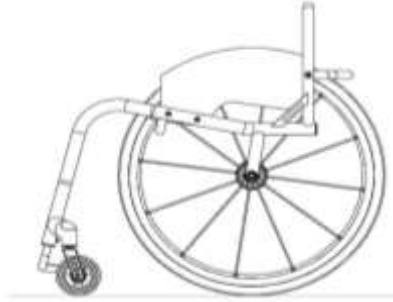

CAD APPROVAL

XW009 QUOTE ONLY (NO CAD FOR APPROVAL)
£0.00

XW011 ORDER (NO CAD FOR APPROVAL)
£0.00

XW012 QUOTE CAD drawing for approval
£312.00 (2 customer amendments ONLY)

XW010 ORDER CAD drawing for approval
£192.00 (2 customer amendments ONLY)

KEY MEASUREMENTS

XY010 Seat width (*Inside of sideguards*)

 mm

(Max - 440mm)
(Min - 250mm)

XY020 Seat length

 mm

(Max - 440mm)
(Min - 250mm)

XY030 Extra seat length (*Provides additional leg support & hand grip*)

 mm

(Max - 440mm total seat)

XY050 Front frame height

 mm

(Max - 520mm)
(Min - 380mm)

XY060 Rear frame height

 mm

(Max - 500mm)
(Min - 360mm)

XY070 Frame length

 mm

(Max - 625mm)
(Min = XY020 + XY030 + 140mm)

XY072 Castor position

 mm

Optimise measurements

XA020 Ergonomic seat
£59.00



Specify length

 mm

(Standard = 120mm)

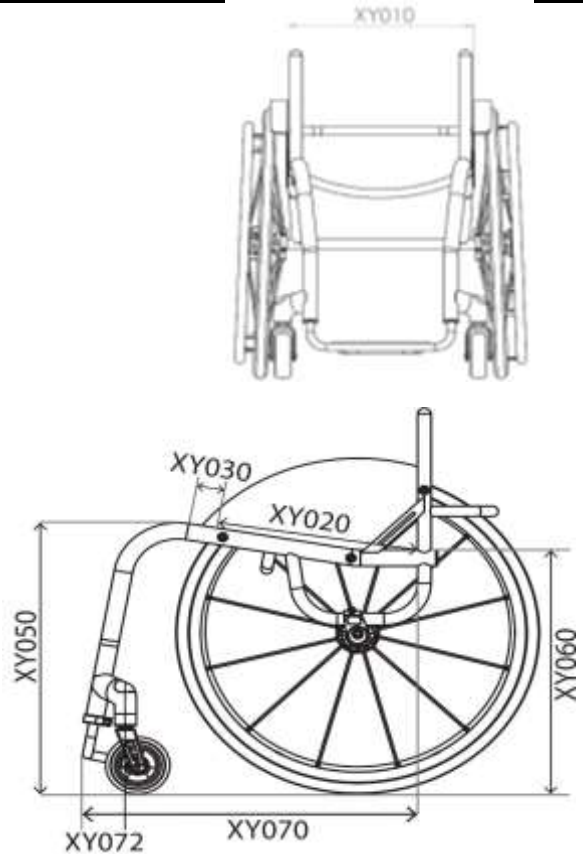

FRONT FRAME AND FOOTREST

Front Frame Options

XY080 Seat taper design

i Specify width mm

(When combined with XY091, dimension is inbetween the centre of the main bends)

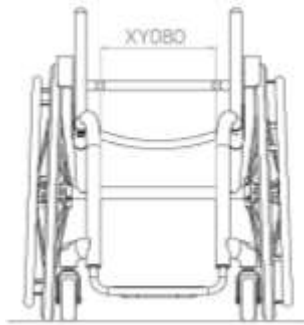

XY091 Parallel taper design

i Specify width mm

(When combined with XY080, dimensions must be smaller by 20mm)

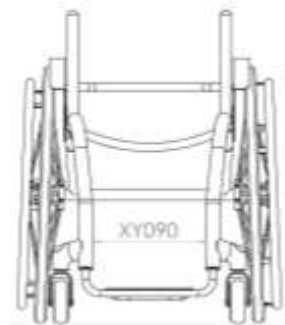

Footrest Design Choose One)

XY100 Round design

Castor Wheel Size	Max Height Achievable
4"	110mm



XY105 Square design

Castor Wheel Size	Max Height Achievable
4"	130mm

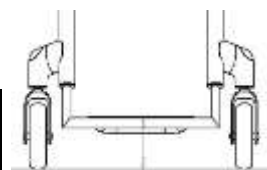

4 XB200 High level footrest (Non-certified Sub4 option) £104.00

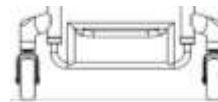

Footrest Measurements

XY115 Front footrest height mm

XY120 Rear footrest height mm

Std = 20 lower than front height

XY125 Footrest length mm

Maximum length 140mm (Certified weight) (160mm and over requires heavy duty upgrade XB150)

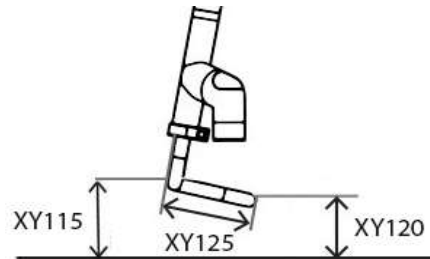

Footrest Style

XB015 Tubular aluminium footrest Sub4 (Height adjustable)

4 XB010 Tubular aluminium footrest (Non Certified Sub4 option) (Height adjustable)

Footrest Cover

XB045 Lightweight carbon fibre cover (With weight saving cut-out)

4 No Cut-Out (Non Certified Sub4 option)

Footplate width Sub4 certified (Std if no option selected)

4 Footplate width Standard (optimised plate width) (Non Certified Sub4 option)

CASTOR WHEELS, FORKS & WHEEL LOCKS

Castor Wheels

XC135 Aluminium centre 4"x1.25"
Choose colour below:

- | | |
|--|---|
| <input type="checkbox"/> Silver hub & black tyre (Std) | <input type="checkbox"/> Green hub & black tyre |
| <input type="checkbox"/> Black hub & black tyre | <input type="checkbox"/> Red hub & black tyre |
| <input type="checkbox"/> Purple hub & black tyre | <input type="checkbox"/> Blue hub & black tyre |

SBAXC155 Forged carbon centre 4"x1.4"
(Non Certified Sub4 option)

XC140 Aluminium centre 5"x1.4" **(Non certified Sub4 option)**
£94.00 **(Silver hub and black tyre only)**

XC145 Aluminium centre 6"x1.4" **(Non certified Sub4 option)**
£94.00 **(Silver hub and black tyre only)**

Castor Forks

XC190 Performance castor fork (Std)
Note: Colour follows accent

XC192 High trail castor fork

Note: Greater distance between contact patch and steering axis reduces flutter at higher speeds. Colour follows accent

Castor Pin Width

XY330 Castor pin width
Optimise measurements
(Minimum width for clear castor rotation and maximum wheelbase length)

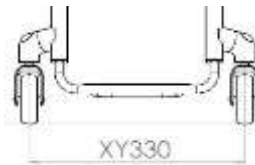

Wheel Lock Options

SBAXD036 Compact scissor with lightweight fixing

XD020 Underseat scissor **(Non certified Sub4 option)**

XD050 Push to lock **(Non certified Sub4 option)**

XD010 Omit wheel locks

SBAXD085 Eagle wheel locks (Indicate colour)
£73.00 **(Non Certified Sub4 option)**

SBAXD086 Eagle WL with L/W fixing (Indicate colour)
£83.00 **(Non Certified Sub4 option)**
(Only with fixed centre of gravity)

- | | | | |
|--------------------------------|---------------------------------|------------------------------|-------------------------------|
| <input type="checkbox"/> BLACK | <input type="checkbox"/> PURPLE | <input type="checkbox"/> RED | <input type="checkbox"/> BLUE |
|--------------------------------|---------------------------------|------------------------------|-------------------------------|

Black Std if no option selected

SIDEGUARDS

Sideguard

XE055 Screw on lightweight carbon fibre

Sideguard with Fender

XE065 Screw on lightweight carbon fibre w/fender

Sideguard Measurements

Individual above tyre (Follow tyre - max. 25mm)

mm

Level with tyre (Follow tyre)

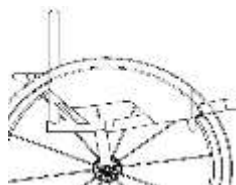

Sideguard Measurements

10mm above tyre (Standard)

Individual above tyre (Min = 10mm)

mm

Centre of tyre

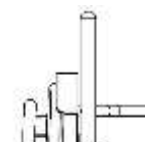
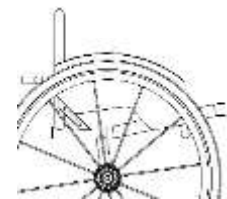

BACKREST

Backrest Measurements



XY230

Backrest height

Specify height

 mm

XG010

Fixed Backrest (non-folding)



SBAXG020
£245.00

Folding backrest with 2 position snap lock and angle adjust **(Non certified Sub4 option)**

Ergonomic Options



XY360

Backrest angle

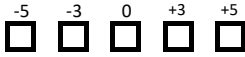

Individual

 Deg

(Max -10/+20 Deg)

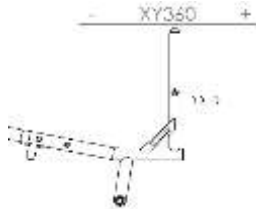

XG100

Ergonomic backrest

£59.00



Vertical height

 mm

Rearward position

 mm

XG110

Inward taper

(inside of backrest posts)

£59.00

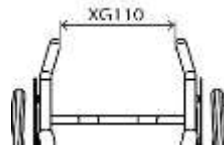

Specify width or per side

 mm

XG120

Outward flare

(inside of backrest posts)

£59.00

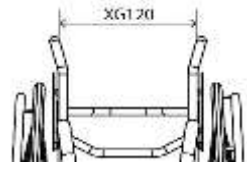

Specify width or per side

 mm

CAMBER BAR

Specify Camber Angle



XY390

Camber angle



SBAXH100

Single post fixed centre of gravity

(25-125mm)

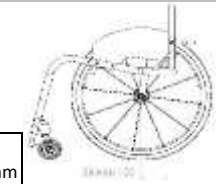
 mm

SBAXH130
£272.00

Square back adjustable centre of gravity (25-125mm) **(Non Certified Sub4 option)**

 mm

SBAXH140
£272.00

Round back adjustable centre of gravity (60-125mm) **(Non Certified Sub4 option)**

 mm

PUSH HANDLES



XG070
£115.00

Screw in push handles **(Non Certified Sub4 option)**



XG080
£176.00

Flip down push handles **(Non Certified Sub4 option)**







ANTI-TIP

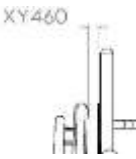

XJ100
£325.00

Single sport anti tip **(Non Certified Sub4 option)**

FRAME FINISH OPTIONS			
Frame and Footrest			
<input type="checkbox"/> SBAXN030 Brushed frame	<input checked="" type="checkbox"/> XN010 Powder coat frame		
<input type="checkbox"/> SBAXN050 Polished frame	Paint code		
Accent Colour (Choose One)			
<i>Note: Accent colour includes, forks & castor caps.</i>			
<input type="checkbox"/> Black accent	<input type="checkbox"/> Silver accent	<input type="checkbox"/> XN250 Individual Accent Colour	
<input checked="" type="checkbox"/> Red accent	<input type="checkbox"/> Blue accent	£127.00	
<input type="checkbox"/> Purple accent	<input type="checkbox"/> Carbon accent <i>(Castor caps only, black for rest)</i>		
UPHOLSTERY			
Seat Upholstery			
<input type="checkbox"/> XP045 Sub4 Seat sling strap adjustable	<input checked="" type="checkbox"/> XR050 Carbon fibre seat plate	£250.00 (Non certified Sub4 option)	
Backrest Upholstery			
<input type="checkbox"/> XP035 Airtech Sub4 backrest strap adjustable	<input checked="" type="checkbox"/> XP050 Airtech backrest strap adjustable	(Non certified Sub4 option)	
	<input checked="" type="checkbox"/> XP070 Backrest upgrade to leather corners (Black)	£89.00 (only with Airtech upholstery XP050) (Non certified Sub4 option)	
	<input checked="" type="checkbox"/> XP110 Backrest with zip pocket	£66.00 (only with Airtech upholstery XP050) (Non certified Sub4 option)	
	<input checked="" type="checkbox"/> XP170 Individual backrest embroidery	£101.00 (only with Airtech upholstery XP050) <i>Please complete page 9</i>	
Backrest Upholstery Stitching Options			
<input type="checkbox"/> Silver	<input type="checkbox"/> Black	<input type="checkbox"/> Blue	<input type="checkbox"/> Individual: _____
<input type="checkbox"/> Red	<input type="checkbox"/> Orange	<input type="checkbox"/> Purple	_____
RGK Logo Colour			
<input type="checkbox"/> White (Std)	<input type="checkbox"/> Black	<input type="checkbox"/> Blue	<input type="checkbox"/> Individual: _____
<input type="checkbox"/> Red	<input type="checkbox"/> Orange	<input type="checkbox"/> Purple	_____

REAR WHEELS (* non certified weight options)	
Rear Wheel Size	
<input type="checkbox"/> XY420 24" Wheels	<input type="checkbox"/> XY430 25" Wheels
Rear Wheel Gap	
<input checked="" type="checkbox"/> XY460 Rear wheel gap	
 <input type="checkbox"/> 15 <input type="checkbox"/> 20 <input type="checkbox"/> 25	
Rear Wheel Options	
<input type="checkbox"/> XK075 Spinergy BLXL 18 blade spoke <i>N/A IN SILVER HUB</i>	<input type="checkbox"/> SBAXK150 Spinergy CLX 18 carbon blade spoke £519.00 <i>N/A IN SILVER HUB</i>
<input checked="" type="checkbox"/> XK226 Titanium 100mm quick release axle pins	
Spinergy Colour Options: 	
<input type="checkbox"/> Black spokes <input type="checkbox"/> White spokes <input type="checkbox"/> Yellow spokes <input type="checkbox"/> Red spokes <input type="checkbox"/> Blue spokes <input type="checkbox"/> Pink spokes <input type="checkbox"/> Purple spokes <input type="checkbox"/> Orange spokes <input type="checkbox"/> Green spokes	<input type="checkbox"/> XK180 Individual spoke design £130.00 <i>(Specify colour)</i> Inside: _____ Outside: _____
Spinergy Anodise Options	
<input type="checkbox"/> XK190 Black hub <i>(std option)</i> <input type="checkbox"/> XK200 Silver hub £68.00 <i>(n/a with BLXL/CLX)</i> <input type="checkbox"/> XK201 Red hub/rims £203.00 <i>(LX, XLX & BLXL only)</i> <input type="checkbox"/> XK205 Individual hub/rims £234.00 Select colour: _____	<input type="checkbox"/> XK202 Purple hub/rims £203.00 <i>(LX, XLX & BLXL only)</i> <input type="checkbox"/> XK203 Blue hub/rims £203.00 <i>(LX, XLX & BLXL only)</i> <input type="checkbox"/> XK204 Gold hub/rims £203.00 <i>(LX, XLX & BLXL only)</i>
Supply Without Wheels	
<input type="checkbox"/> SBAXK040 Supply without Wheels -£350.00	 Wheel Type: <input style="width: 200px;" type="text"/> Tyre Type: <input style="width: 200px;" type="text"/>
Handrim Position / Options	
<input type="checkbox"/> XY480 Narrow set handrim	<input type="checkbox"/> XY485 Wide set handrim
<input type="checkbox"/> XL090 Remove excess mounting tabs £75.00 <i>(recommended for small wheel gaps)</i>	
Handrim Styles	
<input type="checkbox"/> XL010 Aluminium hard anodised 6 tab <i>(Standard if no option selected)</i>	<input type="checkbox"/> XL040 Titanium 6 tab £178.00
<input type="checkbox"/> XL160 Elipse 6 tab £250.00 <i>(replacement for Surge)</i>	<input type="checkbox"/> XL035 Natural Fit LT £223.00
<input type="checkbox"/> XL020 Tetra grip 6 tab £210.00	<input type="checkbox"/> XL150 Carbolife Gekko <input type="checkbox"/> Black <input type="checkbox"/> Silver £442.00
<input type="checkbox"/> XL100 Para grip 6 tab £210.00	<input type="checkbox"/> XL170 Carbolife Curve L (Black) £473.00
Tyre Options	
<input type="checkbox"/> XM060 Schwalbe One (Lightest option) £70.00	<input type="checkbox"/> XM130 Kenda black £26.00
<input type="checkbox"/> XM010 Kenda <input type="checkbox"/> Grey <input type="checkbox"/> Blue <input type="checkbox"/> Red	<input type="checkbox"/> XM050 Kenda K885 mountain bike tyre (24",25" only) £20.00
<input type="checkbox"/> XM020 Schwalbe Marathon Plus £50.00	
<input type="checkbox"/> XM040 Shox solid airless £83.00	
Inner Tube Valve Options	
<input type="checkbox"/> XY500 Schraeder inner tube valve <i>(Standard if no option selected)</i>	<input type="checkbox"/> XY490 Presta inner tube valve
	
* Indicates items that are not part of the certified weight of the Tiga Sub4	

CUSHION (non certified weight options)**

Cushion foam options

- XP080 **£62.00** Cushion foam
(select density and size below)
- Soft (CMS040) Medium (CMS050)
- 50mm 75mm 100mm

Cushion cover upgrades

- XP085 Nylon cushion cover
(Black)
- XP090 **£48.00** Airlite cushion cover
(Black)
- XP100 **£157.00** Leather cushion cover
(Black)

Jay Products - **PLEASE PROVIDE JAY ORDER FORM**

- JAY Cushion
(Price dependant on size / option)
- JAY Backrest
(Price dependant on size / option)
- JAY Whitmyer Headrest
(Price dependant on size / option)

FRAME OPTIONS (non certified weight options)**

- XR060 **£75.00** Welded calf strap mounting loops
(To locate calf strap on front frame)

Specify height from floor

- Optimise measurements

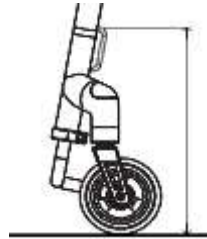

ACCESSORIES (non certified weight options)**

- XR080 **£539.00** Frontwheel assembly
(Only with XB010, TGAXB080, XB150)
- XP120 **£53.00** Frame protectors Neoprene zip fasten (Black)
- XP420 **£35.00** Frame protectors Nylon velcro fasten (Black)
- XR010 **£28.00** Seat pouch velcro attach *(Black)*
- XR200 **£47.00** Rucksack with RGK logo (Black)
- XR090 Tool kit
- XS065 Sub4 Calf Strap

** indicates options that, when chosen, will not enable RGK to guarantee a Sub4kg product weight

DONATE / PART EXCHANGE

Donate your old chair for up to £250 off this order*

*Participating RGK resellers only. Any donation chair must include a functional frame and wheels. RGK will replace the upholstery and arrange delivery to a worthy cause.

Chair Make/Model: _____

Chair Serial/Ref No: _____

Agreed Value: _____

Part Exchange your old chair for up to £750 off this order*

*Participating RGK resellers only. Any Part Exchange chair must be less than 5 years old and include a functional frame, componentry and wheels.

Chair Make/Model: _____

Chair Serial/Ref No: _____

Agreed Value: _____

ADDITIONAL NOTES

INDIVIDUAL BACKREST EMBROIDERY

PLEASE PROVIDE JPEG IMAGE AT TIME OF ORDER AND NOTE POSITION BELOW



BRACE BAR

SPEC NOTES:



OFF SPEC REQUEST*

(please specify below the page number(s) and details to which the off spec request applies.



OFF SPEC REQUEST APPROVED *(for internal RGK office only)*

X

RGK Internal Sign-off

Off spec requests require a feasibility study which may increase order price and lead time. Any dimension/ option/ frame request not listed on the order form will be treated as an off spec request.*