



Elite<sup>2</sup> Plus  
Elite<sup>2</sup> XS  
Elite<sup>2</sup> RS

Instructions for Use



[www.sunrisemedical.com](http://www.sunrisemedical.com)

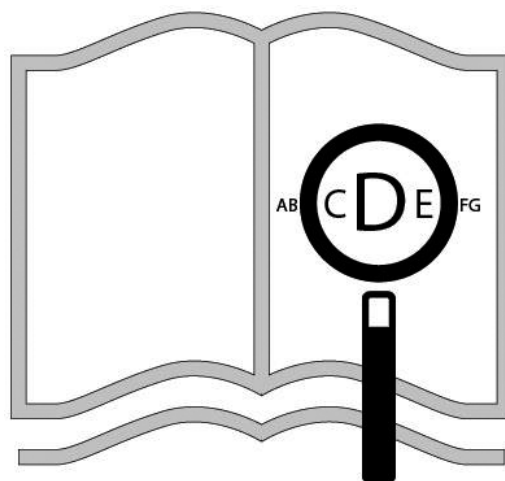

If you are visually impaired, this document can be viewed in PDF format at: [www.Sunrise Medical.co.uk](http://www.Sunrise Medical.co.uk)

For further information on the full specification and options and accessories, please refer to the order form.

All information is subject to change without notification.

Please consult Sunrise Medical with any queries you may have.

 **DANGER!**

**IF YOU REQUIRE LARGE TEXT, SUNRISE MEDICAL STRONGLY RECOMMEND THAT YOU SEEK A CLINICAL EYESIGHT ASSESMENT BEFORE USING THIS PRODUCT.**

Sunrise Medical strongly recommends that in order to ensure that your B4Me product operates, and performs as intended by the manufacturer; all the user information supplied with your B4Me product is read and understood, before the product is first used.

Sunrise Medical also recommends that the user information is not discarded after reading it, but it is kept safely stored for future reference.

It may be possible to combine this Medical device with one or more other Medical Device or other product. Information on which combinations are possible can be found at [www.Sunrisemedical.co.uk](http://www.Sunrisemedical.co.uk). All combinations listed have been validated to meet the General Safety and Performance Requirements, Annex I Nr. 14.1 of the Medical Device Regulation 2017/745.

Guidance on the combination, such as mounting, can be found at [www.SunriseMedical.co.uk](http://www.SunriseMedical.co.uk)

## Foreword

Dear Customer,

We are very happy that you have decided in favour of a high-quality SUNRISE MEDICAL product.

This user's manual will provide numerous tips and ideas so that your new scooter can become a trustworthy and reliable partner in your life.

We want you to be satisfied with our products and service. Sunrise Medical has been consistently working at continuously developing its products, for this reason, changes can occur in our palette of products with regard to form, technology and equipment. Consequently, no claims can be construed from the data or pictures contained in this user's manual.

The management system of SUNRISE MEDICAL is certified to ISO 9001, ISO 13485 and ISO 14001.

 **As the manufacturer, SUNRISE MEDICAL, declares that the scooters conform to the Medical Device Regulation (2017/745).**

NOTE: General user advice.

Not following these instructions may result in physical injury, damage to the product or damage to the environment!

A notice to the user and/or patient that any serious incident that has occurred in relation to the device should be reported to the manufacturer and the competent authority of the Member State in which the user and/or patient is established.

Please contact your local, authorised SUNRISE MEDICAL dealer if you have any questions regarding the use, maintenance or safety of your scooter.

In case there is no authorised dealer in your area or you have any questions, contact Sunrise Medical either in writing or by telephone (contact addresses can also be found on the back page).

Sunrise Medical  
Thorns Road  
Brierley Hill  
West Midlands  
DY5 2LD  
Phone: 0845 605 66 88  
Fax: 0845 605 66 89  
www.SunriseMedical.co.uk

## Use

Intended Use of Scooter's.

Class C Scooter's are usually large in size, not necessarily intended for indoor use but capable of travelling longer distances and negotiating outdoor obstacles.

They are intended for use in public places and similar locations where there are pavements, pedestrian paths or floors that have hard and firm surfaces. The safe limit for slopes and obstacles shall be observed.

They may be used on the roads in compliance with local country traffic law. They are intended for a user who has difficulty in walking or limited mobility and is for their own personal use.

The maximum user weight limit, includes both the user and any weight of accessories fitted to the scooter), is marked on the serial number label, which is affixed to the seat post or rear frame.

Warranty can only be taken on if the product is used under the specified conditions and for the intended purposes. No unauthorised modifications should be made to the Scooter. Only approved parts and accessories shall be fitted.

### Lifetime:

The intended lifetime of the scooter is 5 years. Please DO NOT use or fit any 3rd party components to the scooter unless they are officially approved by Sunrise Medical.

## Area of application

### Indications

The varieties of fitting variants, as well as the modular design, mean that it can be used by those who cannot walk or have limited mobility because of:

- Paralysis
- Loss of extremity (leg amputation)
- Extremity defect deformity
- Joint contractures/joint injuries
- Strokes and brain injuries
- Neurological disabilities
- Illnesses such as heart and circulation deficiencies, disturbance of equilibrium or cachexia as well as for elderly people who still have strength in the upper body.

### Contraindications

The mobility scooter shall not be used in case of:

- Perception disorder
- Imbalance
- Loss of both arms
- Joint contracture/joint damage on both arms
- Seating disability

The following should be taken into consideration in relations to the provision of the scooter and any specific options available:

- The users body size, weight including the distribution of body weight.
- The mass of any carry on or stowed items should be added to the users body mass and together should not exceed the maximum load of the scooter.
- The user's physical and psychological constitution.
- The age of the user, their living conditions and the environment in which the scooter is going to be used, eg home surroundings and the intended area of use.





If in doubt, please consult a health care professional to ensure the user is not exposed to unacceptable risks. A risk assessment may be required in certain circumstances.

Sunrise Medical is ISO 13485 certified, which ensures quality at all stages of the development and production of this scooter.

**IMPORTANT:**  
 **DO NOT USE YOUR SCOOTER UNTIL THIS MANUAL HAS BEEN READ AND UNDERSTOOD.**

## Definitions

### Definitions of words used in this manual

Word	Definition
 <b>DANGER!</b>	Advice to the user of Potential Risk of serious injury or death if the advice is not followed
 <b>WARNING!</b>	Advice to the user of a potential risk of injury if the advice is not followed
 <b>CAUTION!</b>	Advice to user that potential damage to equipment may occur if the advice is not followed
<b>NOTE:</b>	General advice or best practice
	Reference To Additional Documentation

#### NOTE:

- The scooter shown and described in this user guide may not correspond in every detail exactly to your own model. However, all instructions are completely relevant, regardless of possible detail differences.
- Further information and safety instructions can be provided by your authorized dealer.
- The manufacturer reserves the right to alter without notice any weights, measurements or other technical data shown in this manual. All figures, measurements and capacities shown in this manual are approximate and do not constitute specifications.

#### NOTE:

- Please keep a note of your local service agent's address and telephone number in the space provided.
- In the event of a breakdown, contact them and try to give all relevant details so they can help you quickly.

Dealer signature and stamp

## CONTENTS

<b>FOREWORD</b>	<b>3</b>
<b>USE</b>	<b>3</b>
<b>AREA OF APPLICATION</b>	<b>3</b>
<b>DEFINITIONS</b>	<b>4</b>
<b>FEATURES OF STERLING ELITE<sup>2</sup> - XS - RS</b>	<b>4</b>
<b>FEATURES OF STERLING ELITE<sup>2</sup> PLUS</b>	<b>6</b>
<b>1.0 YOUR SCOOTER</b>	<b>7</b>
<b>2.0 HOW TO USE THIS MANUAL</b>	<b>8</b>
<b>3.0 LABEL IDENTIFICATION</b>	<b>8</b>
<b>4.0 SAFETY INFORMATION</b>	<b>9</b>
<b>5.0 ASSEMBLY &amp; OPTIONS</b>	<b>15</b>
<b>6.0 USING THE SCOOTER</b>	<b>24</b>
<b>7.0 SCOOTER CONTROL SYSTEM</b>	<b>29</b>
<b>8.0 TROUBLESHOOTING USING THE LCD</b>	<b>40</b>
<b>9.0 BATTERIES AND CHARGING</b>	<b>42</b>
<b>10.0 ADJUSTMENTS</b>	<b>45</b>
<b>11.0 CLEANING</b>	<b>46</b>
<b>12.0 SHIPPING AND STORAGE</b>	<b>47</b>
<b>13.0 DISPOSAL</b>	<b>48</b>
<b>14.0 TORQUE SETTINGS</b>	<b>49</b>
<b>15.0 SPECIFICATION SHEETS</b>	<b>50</b>
<b>16.0 GUARANTEE</b>	<b>52</b>
<b>17.0 SERVICE ADVICE/HISTORY</b>	<b>52</b>
<b>18.0 SERVICE AND MAINTENANCE</b>	<b>53</b>
<b>19.0 NAME PLATE</b>	<b>57</b>

## Features of Sterling Elite<sup>2</sup> - XS - RS

See Fig.A

- A. SEAT SWIVEL LEVER**
- B. CHARGING SOCKET**
- C. TILLER ADJUSTER**
- D. CONTROL FASCIA**
- E. WIG-WAG THROTTLE LEVERS**
- F. PARKING BRAKE LEVER**
- G. SEATING**
- H. ON-OFF KEY SWITCH**
- I. FLIP-UP ARM RESTS**
- J. FREEWHEEL LEVER**
- K. TYRES**
- L. SERIAL NUMBER LABEL, (ON SEAT POST)**
- M. BATTERY COVER (BATTERIES)**
- N. FOOT BOARD**
- O. BUMPER**
- P. FRONT SUSPENSION**
- Q. LED LIGHTS**
- R. FRONT BASKET (MAX. 5KG)**

Fig.A



Due to its modular design, simplicity and wide range of adjustments, the Sterling Elite2 XS, RS is a perfect choice for easy service, refurbishment and recycle requirements.

As a part of our ongoing product improvement initiative, Sunrise Medical reserves the right to change specifications and design without notice. Further, not all features and options offered are compatible with all configurations of the scooter.

All dimensions are approximate and may be subject to change.



Due to its modular design, simplicity and wide range of adjustments, the Sterling Elite<sup>2</sup> PLUS is a perfect choice for easy service, refurbishment and recycle requirements.

As a part of our ongoing product improvement initiative, Sunrise Medical reserves the right to change specifications and design without notice. Further, not all features and options offered are compatible with all configurations of the scooter.

All dimensions are approximate and may be subject to change.

## Features of Sterling Elite<sup>2</sup> Plus

See Fig.B

- A. SEAT SWIVEL LEVER
- B. CHARGING SOCKET
- C. TILLER ADJUSTER
- D. CONTROL FASCIA
- E. WIG-WAG THROTTLE LEVERS
- F. PARKING BRAKE LEVER
- G. SEATING
- H. ON-OFF KEY SWITCH
- I. FLIP-UP ARM RESTS
- J. FREEWHEEL LEVER
- K. TYRES
- L. SERIAL NUMBER LABEL, (ON SEAT POST)
- M. BATTERY COVER (BATTERIES)
- N. FOOT BOARD
- O. BUMPER
- P. FRONT SUSPENSION
- Q. LED LIGHTS
- R. FRONT BASKET (MAX. 5KG)

## 1.0 Your Scooter

### 1.1 PRODUCT INFORMATION:

We at Sunrise Medical want you to get the best out of your Sterling Elite<sup>2</sup> RS, XS, PLUS scooter. This Owner's Manual will familiarise you with the scooter and its features. It contains hints on everyday usage and general care in addition to information on the high quality standards which we adhere to and details about the guarantee.

Your scooter should be delivered fully configured for your use; there are a wide range of components and adjustments available on the Sterling Elite<sup>2</sup>. For further information about these you should contact your Sunrise Medical authorised dealer.

Your scooter will reach you in excellent condition having been personally inspected before leaving our factory. Following the guidelines for maintenance and cleaning your scooter will maintain its first class condition and give you complete satisfaction.

This Scooter is designed for comfort, safety and durability and has been exhaustively researched and tested by our experts. The Elite<sup>2</sup> XS, RS and PLUS model scooter is classified as a category C vehicle under the European scooter standard EN 12184.

It is intended for the use of people of all ages who may have difficulty walking distances or for periods of time. It is ideal for indoor and outdoor use and suitable for users up to 175kg in weight. Variation in load weight can affect performance. Maximum user weight tested using 175kg test dummy. The scooter is designed to be driven on paved or tarmac footpaths and roads but should not be driven through mud, water or snow which is deeper than 50mm. If you are in any doubt as to the suitability of the power scooter, contact your local Sunrise Medical approved supplier for clarification, prior to commencing use.



It is very important to read the relevant section of the owner's manual when making any minor adjustments. Consult the Technical Manual or your local Sunrise Medical authorised dealer for more complex adjustments.

If you have any queries about the use, maintenance or safety of your scooter, please contact your local approved Sunrise Medical service agent. If you do not know of an approved dealer in your area or have any other questions please write or telephone:

Sunrise Medical  
Thorns Road  
Brierley Hill  
West Midlands  
DY5 2LD  
England  
Phone: 0845 605 66 88  
Fax: 0845 605 66 89  
[www.SunriseMedical.co.uk](http://www.SunriseMedical.co.uk)



## 2.0 How to Use This Manual

### 2.1 INTRODUCTION:

Please keep a note of your local service agent's address and telephone number in the space below.  
 In the event of a breakdown, contact them and try to give all relevant details so they can help you quickly.  
 The scooters shown and described in this manual may not be exactly the same in every detail as your own model. However, all instructions are still entirely relevant, irrespective of detail differences.

**NOTE :** The manufacturer reserves the right to alter without notice any weights, measurements or other technical data shown in this manual. All figures, measurements and capacities shown in this manual are approximate and do not constitute specifications.

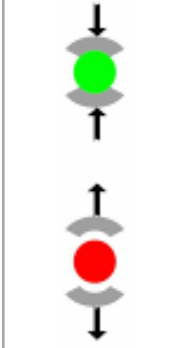
## 3.0 Label Identification

LABEL	MEANING
	<p>This label shows the model number, serial number, max weight and manufacturer details.</p>
	<p>This label shows the position of the freewheel lever..</p> <p style="text-align: center;"><b>DRIVE</b></p> <p style="text-align: center;">↑↓</p> <p style="text-align: center;"><b>FREEWHEEL</b></p>
	<p>This label shows the location of the power ON and OFF for the scooter and 'read the user manual' warning.</p>
	<p>This label warns about the possibility of finger entrapment or pinching.</p>



## 4.0 Safety Information

If you follow the instructions given in this manual, you will enjoy many trouble-free years of use.

### 4.1 GENERAL WARNINGS:

#### ⚠️ WARNING!

- This scooter can be used on the road, ensure all local traffic regulations and health requirements, (such as eye sight), are understood and adhered to.
- Load data always refers to one single person as operator.
- The scooter is authorised for use by one person.
- Do not operate your Scooter whilst under detrimental influence of alcohol, drugs or bouts of severe/acute illness .
- Please observe all relevant rules and regulations pertaining to pedestrians and road users, at all times.
- Always ensure that your scooter is switched off before attempting to mount or dismount.
- Always ensure that you are able to operate all controls from a comfortable position. Paying attention to your posture is essential to ensure your continued comfort and well being.
- Always make sure that you can be seen clearly, especially if you intend using your scooter in poor light.
- Switch on the scooter lights to make yourself visible when there are low levels of light , day or night.
- The scooter has been built to match the needs of the majority of users. If a personal risk assessment highlights specific needs, the scooter may need to be adjusted and/or reprogrammed.
- Do not let children or others use your scooter.
- Do not lift or hoist the scooter by any detachable parts such as leg rests, arm rests etc.

#### ⚠️ CAUTION!

### 4.2 FEATURES AND OPTIONS:

Some of the options shown in this manual may not be available in your country and may also restrict the overall physical limits of the standard product (e.g. max. speed, user weight limit, range, etc.).



Any limitations are marked on the order form, in the technical manual and in this owner's manual. For further information please consult your Sunrise Medical authorised dealer.

#### ⚠️ DANGER!

### 4.3 PRELIMINARY CHECKS:

- Always check that Drive is selected before setting the scooter in motion.
- The scooter emits an audible warning when Freewheel is selected and will not allow the scooter to drive.
- You should not try to manoeuvre at full speed.
- If you have to make a sudden turn, slow down first by releasing the control lever or the speed control feature, this is very important if you are going down a hill.
- Failure to slow down during a manoeuvre may result in your overturning the scooter.
- Always check that the scooter is switched off before trying to get on or off.
- Always check that you can be seen clearly, especially if you are using the scooter in conditions of low visibility.

### 4.4 EMERGENCY BRAKING:

#### ⚠️ WARNING!

If power is cut by means of the ON/OFF key switch, braking will be immediate and total. This method of stopping is not recommended except for emergencies, since the stop will be extremely sudden.

#### ⚠️ CAUTION!

Routine use of emergency braking will cause damage to your Scooter.

### 4.5 KERBS, (FIG 4.1):

#### ⚠️ DANGER!

- Be aware of other vehicles and pedestrians when kerb climbing.
- Do not attempt to mount kerbs in excess of 100mm (4").
- Always mount and dismount kerbs with caution and directly facing the kerb.
- Do not attempt to mount or dismount kerbs in reverse.
- Do not attempt to descend from, a kerb of more than 100 mm. height.
- Do not attempt to ascend high kerbs, steep slopes or cambers due to the risk of falling out of the scooter or tipping over.
- Do not attempt to ascend any kerb in the vicinity of a drain cover, uneven surfaces, or gravel covering.
- Do not attempt to climb or descend any kerb at an oblique angle. Approach only at an angle of 90° with at least 500mm run-up.

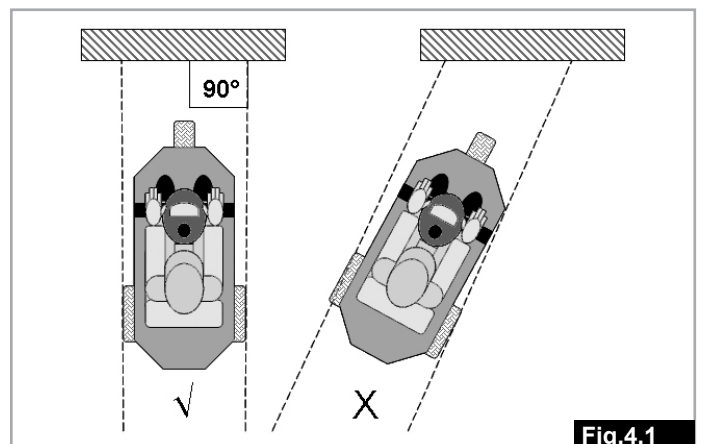

Fig.4.1

#### 4.6 TYRES:

The tyres of a scooter suffer wear depending on how much the scooter is used. Check them regularly, especially for inflation pressure, according to the service instructions in this manual.

Each tyre pressure should be:

Elite2 XS & RS = 1.8-2.0 bar (25-28 P.S.I.)

Elite2 Plus = 2.4-2.5 bar (33-35 P.S.I.).

See section 5.26 for solid tyre information.

#### DANGER!

Never inflate the tyres with a service station air pump. It is recommended that you use a manual pump or a pressure regulator (manometer)

#### 4.7 FREEWHEEL DEVICE, (FIG.4.2):

The scooter has two modes of movement: Drive or Freewheel.

- DRIVE = All movement, including braking, is exclusively controlled by operation of the electronic control system.
- FREEWHEEL = Movement is by manual means. Movement can also occur due to gravity, (pot holes, kerbs, hills or inclines etc).

Push the lever up for drive and down for freewheel.

#### DANGER!

- Only use the freewheel function to push the scooter manually from one spot to another.
- Keep in mind that while the freewheel system is in operation, the scooter is without a braking system.
- Selecting freewheel causes a loud audible warning beeping tone from the scooter horn.
- For safety reasons the scooter can no longer be moved using the control levers.
- Do not operate the freewheel device whilst seated in the scooter
- The freewheel device should only be operated by a person who has the strength and agility to be able to fully manoeuvre the scooter safely, during freewheel.
- Always put the scooter back in drive.
- Always check that drive is engaged before using the scooter.
- Do not disengage the freewheel on or near a slope.
- Do not allow yourself to be pushed by others whilst the scooter is in freewheel.

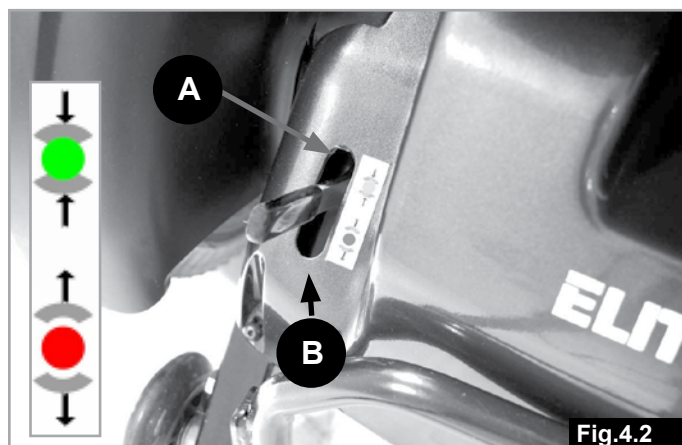

#### WARNING!

#### 4.8 EMC - RADIO TRANSMITTING DEVICES:

When operating two-way radio, walkie-talkies, C.B., amateur radio, public mobile radio and other powerful transmitting devices the scooter should be brought to a halt and turned off. The operation of cordless, mobile telephones and cell phones including hands-free devices is permitted but if abnormal operation of the scooter is encountered then the scooter must be brought immediately to a halt and turned off.

**NOTE:** the electrical systems of the scooter may disturb the performance of alarm systems in retail shops.

#### DANGER!

#### 4.9 SHARP TURNS:

Full speed turns should not be attempted. If you need to turn sharply you must reduce your speed with the control panel speed setting. This is particularly important when travelling across or down a slope. Disregarding this advice could lead to your scooter tipping over.

#### DANGER!

#### 4.10 WEIGHT LIMIT:

- The user, plus options and accessories, plus items carried should never exceed a total weight of 175 kg.
  - Never sit in the scooter whilst weight training if the total weight (user plus additional weights) exceed a total weight of 175 kg.
  - Exceeding the weight limit is likely to damage the seat, frame or fasteners and may cause severe injury to you or others from scooter failure
  - Exceeding the weight limit will void the warranty
- Scooter motors:
- Do not hang shopping bags from the handlebars as they could swing and cause loss of steering control.

#### 4.11 HOT/COLD SURFACES:



**WARNING!**

After prolonged use, the drive unit motors will produce heat, which is radiated through the motors' outer casing.

- Do not remove the rear drive unit cover after using the scooter.
- Do not touch the motors' outer casing for at least 30 minutes after using the scooter, to allow it to cool.
- Not only motors can become hot during the operation of the scooter, the seat upholstery material and armrests may heat up when standing in the sun.
- Be aware that in extremely cold weather, exposed metal parts can present a freeze burn hazard, particularly if the hands are wet.

#### 4.12 ROAD CAUTION:

Please show the utmost consideration for pedestrians and other road users.



**DANGER!**

- Remember that the last thing a car or lorry driver expects to see is a scooter driving off the kerb into the road.
- If in any doubt, do not risk crossing the road until you are certain that it is safe.
- When crossing roads, do so as quickly as possible; there may be other traffic.
- Be seen! Always wear something bright such as light coloured clothing, a reflective tabard or day glow vest.
- At night, in dull conditions or in poor visibility, always use the lights, particularly when driving on the road.
- Obey all of the rules for pedestrians and traffic.
- Remember, on the road you are traffic, on the footpath and when crossing the road you are a pedestrian.
- Whilst driving on the road do not drive up one-way streets the wrong way, use the footpath with the speed control set at the appropriate speed, (less than 4mph-6kph).
- Do not hang bags off the handle bars or tiller adjustment lever.

#### 4.13 TRANSPORTATION IN VEHICLES:

This scooter is not suitable to use as a seat in a vehicle.



**Not crash tested**



**DANGER!**

A scooter secured in a vehicle will not provide the equivalent level of safety and security of a vehicle seating system. It is always recommended that the user transfers to the vehicle seating.

**NOTE:** For transportation by road, rail, sea or air please refer to Section 12, Shipping and Storage.

#### 4.14 ADVERSE CONDITIONS:



**DANGER!**

Be aware that when driving your scooter in adverse conditions, e.g. on wet grass, mud, ice, snow or other slippery surfaces, you may experience a reduction in the grip and traction of your scooter. We recommend you take extra precautions in these conditions, particularly on hills and slopes; your scooter could become unstable or skid causing possible injury.



**DANGER!**

When you are using a Powered Scooter or Wheelchair, take extra care with loose or long items of clothing. Moving parts, such as wheels, can be potentially dangerous or even fatal if clothing becomes entangled.

**NOTE:** Extreme variances in temperature may trigger the self protect mechanism in the control system. If this occurs the control system will temporarily shut down to prevent damage to the electronics or the scooter.

#### 4.15 RAMPS FOR TRANSPORTING SCOOTER:



**DANGER!**

- When using a ramp, please ensure that it is capable of taking the combined weight of the scooter and yourself.
- If a ramp is being used to load a scooter into a vehicle, please ensure the ramp is properly secured to the vehicle.
- Always approach the ramp head-on and exercise caution.
- Please ensure the ramp is suitable for the product you are transporting.
- Maximum ramp angle = 10° (18%)
- Follow all the user instructions supplied with the ramp.
- Be aware that accessories attached to the scooter, may affect the overall stability.

## 4.16 TRANSFER TO AND FROM THE SCOOTER

### Mounting your Elite<sup>2</sup> scooter

1. Ensure that the key is turned to the off position.
2. Stand at the side of the scooter and lift the nearest arm rest, (Fig.4.3).
3. Push the seat rotate lever forwards and rotate the seat until it faces you, (Fig. 4.4 - 4.5).
4. Make sure that the seat is locked securely into position.
5. Position yourself comfortably in the seat (Fig.4.6).
6. Push the seat rotate lever forwards and rotate the seat until facing forward (Fig.4.7).
7. Make sure that the seat is locked securely into position and the arm rest is down, (Fig.4.8).
8. Ensure that your feet are placed firmly on the foot board of the scooter and that you can reach all the controls comfortably, (Fig.4.8).



### 4.3.2 Dismounting your Elite<sup>2</sup> scooter

1. Bring your Elite<sup>2</sup> scooter to a complete stop.
2. Make sure that the key is turned to the off position.
3. Push the seat rotate lever forwards and rotate the seat until you are facing the side of the scooter, (Fig.4.6).
4. Make sure that the seat is locked securely into position and that both feet are on the ground.
5. Carefully get out of the seat and stand by the side of your scooter, (Fig.4.5).
6. You may leave the seat in this position or return it to facing forward.

### 4.17 ANTI TIPS:

#### **WARNING!**

- Ensure the anti tips are fitted before using the scooter.
- Ensure that anti tips are not damaged or worn before using your scooter.
- Attendants must be aware of the location of the anti tips to prevent feet being trapped underneath causing injury.
- Do not allow adults or children to stand on the anti tips, or any other part of the scooter as this could cause the scooter to become unstable.



#### 4.18 USE ON A SLOPE:

Your scooter has been designed and tested to allow its use on slopes or gradients of up to 10° (18%). To improve stability lean forward when driving uphill. Set the seat to its lowest height in the furthest forward position and set the back upright. When travelling downhill sit in an upright position or recline the back rest slightly to compensate.

#### ⚠️WARNING!

- Do not exceed the maximum slope of 10°.
- Stop and return the back rest to an upright position before attempting to climb a slope. Failure to do this may cause the scooter to become unstable.
- If you are in any doubt about the capabilities of your scooter on a slope then do not attempt to drive up or down the slope/kerb; try to find an alternative route.
- Wherever possible always travel up or down the slope directly facing the slope, (Fig.4.9).
- Never attempt a non-stop “U” turn when going up or down steep slopes, (Fig.4.9).
- Be aware that accessories attached to the scooter, may affect the overall stability.

#### 4.19 GRADIENTS: ASCENTS:

When going uphill, keep the scooter moving if it is safe and clear to do so.

Manoeuvre by using gentle tiller and throttle movements. The seat should be set to its lowest height in its furthest forward position and the back should be upright.

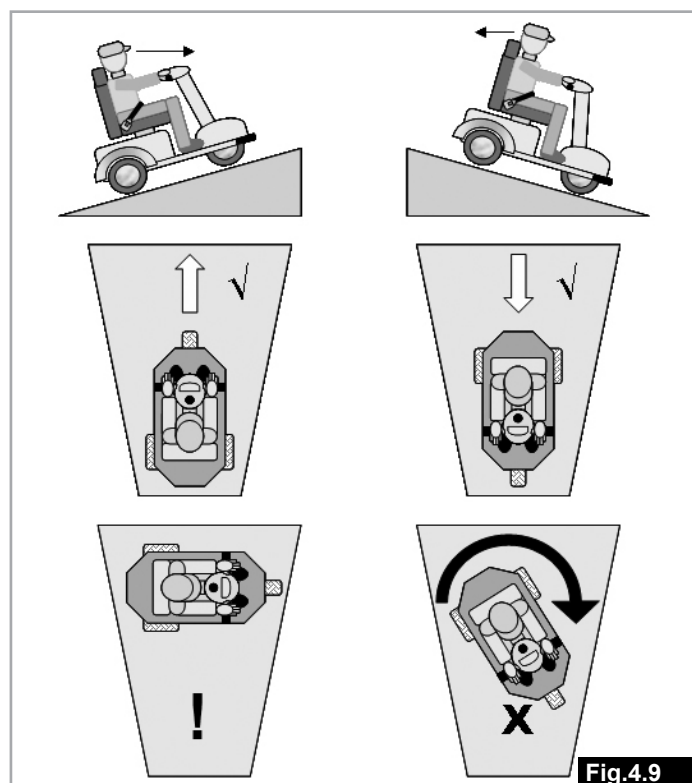

Fig.4.9

#### ⚠️WARNING!

- If you have stopped on a hill, you should start off again slowly.
- Avoid sudden acceleration or hard braking.
- Avoid hard turns

#### 4.20 GRADIENTS: DESCENTS:

#### ⚠️WARNING!

- On descents, it is important not to let the scooter accelerate beyond its normal level of ground speed.
- It is safer to proceed slowly down steep descents (below the speed of 3mph, 5kph) and stop, if any anxiety arises regarding the descent.
- If the scooter picks up speed, release the control lever to stop all forward movement, then restart slowly and do not allow the speed to increase beyond a comfortable level.

#### 4.21 LAP BELT (OPTIONAL ACCESSORY)

Before using your scooter ensure the Lap belt is worn and correctly adjusted before use.

The lap belt is fitted to the scooter as shown in the fitting photographs, (Fig.4.13 - 4.15). It is important that the belt is fitted correctly and is not twisted.

The belt is adjusted automatically to the correct tension by the inertia reel system.

#### To lock the belt:

Pull the buckle over your lap and push firmly into the slot in the receiver, (1).

The belt will adjust to the correct tension. Ensure that there is no excess belt material, and the belt is tensioned correctly. (Fig 4.12)

#### To release the belt:

Push the red button marked 'PRESS' to release the belt, (2), (Fig 4.10).

#### ⚠️DANGER!

- The lap belt is an order form option, factory installed by Sunrise Medical.
- For your comfort, the Lap Belt must be correctly fitted to the scooter. If you are unsure about the fitting or operation of this option, please contact your approved Sunrise Medical dealer.
- Generally the Lap Belt should be fixed so that the straps sit at an angle of approximately 45°, and when correctly adjusted should not allow the upper body to slip down in the seat, (Fig.4.11)

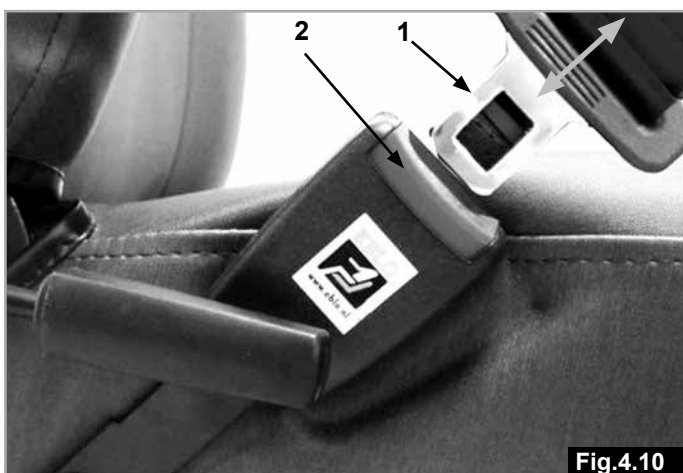

Fig.4.10

**⚠ DANGER!**

- The lap belt is not suitable for use when the scooter and occupant are transported in a vehicle. Always use the separate occupant lap and diagonal restraints provided in the vehicle.
- The lap belt must be checked on a daily basis to ensure it is adjusted correctly and it is free from any obstruction or adverse wear.
- Failure to make sure that the lap belt is secure and adjusted prior to use could cause serious injury to the user. E.g. too loose a strap may allow the user to slip down in the seat and risk suffocation.

**Maintenance:**

- Check lap belt, and securing components; at regular intervals for any sign of fraying or damage.
- Replace if necessary.
- Clean the lap belt with warm soapy water and allow to dry.
- The lap belt should easily allow a hands width of space between the body and the belt, (Fig.4.12).
- Sunrise Medical also recommend that the fit of the belt is checked on a daily basis to reduce the risk of the end user inadvertently re-adjusting the belt to an excessive length.
- If in doubt about the use and operation of the seat belt then ask your healthcare professional, dealer, or carer for assistance.

For your comfort, the Lap Belt must be correctly fitted to the scooter. If you are unsure about the fitting or operation of this option, please contact your approved Sunrise Medical dealer.

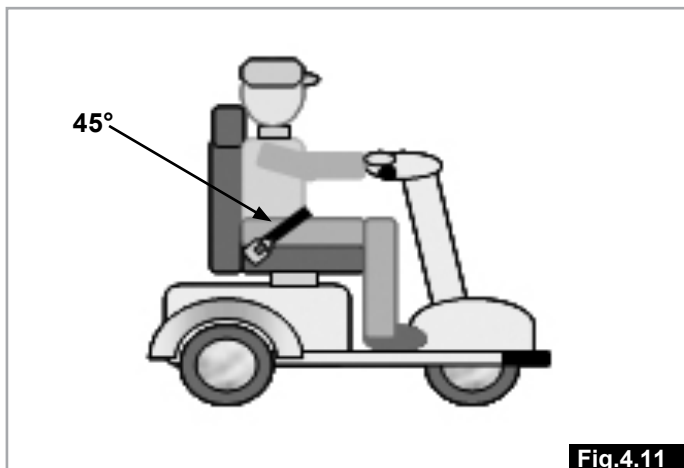

## 4.22 SAFETY CHECKS

### **WARNING!**

- The scooter rider plus items should never exceed a total weight of 175 kg.
- Before you use the scooter, check that it is not in freewheel and that all of the controls are functioning correctly.
- If you discover any scooter malfunction, take it to be repaired or reset. Your dealer can help you to find the fault and correct it.
- Make sure batteries are charged. Do not use the scooter when battery is low. The scooter may come to a sudden, unexpected stop.
- Be aware that there is a point during every transfer when the scooter seat is not below you.
- Use extra care when you drive your scooter in reverse. If one of the wheels hits an obstacle, you could lose control of the scooter or fall out.
- Never use your scooter on a slope unless you are sure you can do so without losing traction.
- When travelling along, always ensure the backrest is upright and the seat faces forwards.
- Lift the scooter only by non-detachable parts of the main frame.
- Never short-circuit electrical connections as you could cause an explosion.
- Do not use the scooter if any of the tyres are damaged or under/over-inflated.
- When using mobile phones you should switch the scooter off.
- Do not smoke whilst on-board the scooter.
- If you take a break from driving, but remain seated in the scooter for more than just a moment, switch the scooter off at the ignition key.

## 5.0 Assembly & Options

### 5.1 SEAT ADJUSTMENTS

#### **WARNING!**

Observe correct lifting techniques at all times when lifting components over 10kg.

**Flip Up Armrests** (Fig 5.1): By pulling up on the end of either armrest, the armrest will flip back for easy transfer on and off of your Elite2.

**Seat Rotate Lever** (Fig 5.2): This is found under the left side of the seat. Push it forwards to allow the seat to rotate 360 degree and release to lock in any 45 degree position desired.

**Seat Height Adjustment:** (Fig 5.3) The seat post is height adjustable, providing 4 height positions. Carefully unscrew the 2 bolts and nuts, and insert into desirable position and tighten nut.

**Sliding Mechanism** (Fig. 5.4): This allows forward and backward movement of the seat. Pull up lever found under the front of the seat and use legs and body to move to the required position and release lever.

### **Seat Removal** (Fig 5.5 - 5.8)

1. Push the seat rotate lever forwards and turn seat to face the front.
2. Stand behind the seat, flip up the arm rests and fold the backrest forward by lifting up the backrest adjustment lever.
4. Place hands on either side of seat base, push the seat rotate lever forwards and lift the seat vertically keeping back posture upright. Bend the knees if required.

### 5.2. ANTI-TIP WHEELS:

These are factory fitted and should not be removed. The anti-tip assembly is bolted to the rear frame of the scooter, (Fig 5.8).

#### **WARNING!**

Never use the scooter without the anti-tip wheels fitted.

### 5.3 BATTERIES:

 Read section 9.0 of this manual for additional battery and charging information.

#### **DANGER!**

- Do not smoke near, or expose the batteries to direct heat (i.e. naked flame, gas fire).
- Do not attempt to change the fuses yourself.
- Do not attempt to by-pass the fuse as this would be very dangerous and could cause a fire.
- If you suspect a fault, contact your Sunrise Medical authorised dealer as soon as possible.
- Do not short circuit the battery terminals. Remember tools, jewellery etc can conduct and if dropped across the battery terminals may cause severe burns and/or explosion!
- Ensure the rubber battery terminal covers are fitted.
- Batteries are heavy. Use correct lifting techniques when removing them from the scooter.
- Always use the handles provided to lift the batteries.
- Always refit the retaining bar after refitting or replacing the batteries.



Fig.5.1



Fig.5.5



Fig.5.2



Fig.5.6

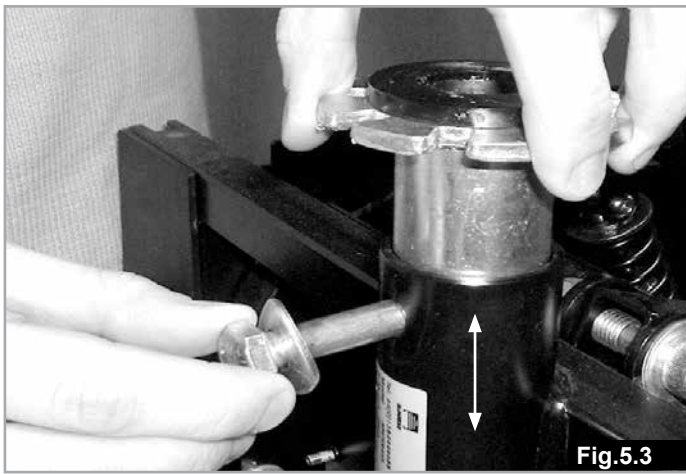

Fig.5.3



Fig.5.7



Fig.5.4

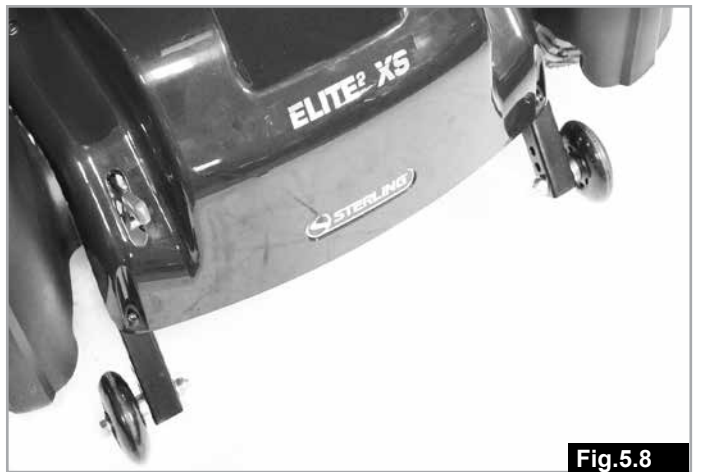

Fig.5.8



### Battery Removal:

1. Remove the seat (Fig 5.5 - 5.8)
2. Remove the Battery cover by lifting the small elastic strap off the holding peg and lifting it off (Fig 5.9)
3. Pull the two halves of the plastic battery connector plugs apart, (Fig 5.10).
4. Remove the battery retaining bar by pulling out one clip and sliding the bar through the hole (Fig 5.11).  
**NOTE:** There are two holes used for this bar, so note which position is being used and refit the bar accordingly.
5. If replacing the batteries or battery looms, pull back the rubber terminal cover and disconnect battery terminals, using a 11.0mm spanner (Fig 5.12).
6. Bend knees with battery positioned centrally in front of you, rest your forearms on your knees for support (Fig 5.13).
7. Grab battery handle with both hands (Fig 5.13).
8. Lift vertically by straightening legs, keeping back posture upright (Fig 5.14).
9. Move the battery to a safe place, keeping back posture upright and bending knees when setting it down.

**NOTE:** If changing the batteries for a different size replacement, it may be necessary to adjust the height of the battery retaining bar to suit the new batteries. It may also be necessary to fit the sticky backed foam battery box packer strip to prevent any sideways play. Simply cut the strip to the desired length. If greater depth is required, stick one strip on top of the other.

### Battery Weights:

Battery Type	Weight kg
MK 60 amp (at 20Hr)	19.3
MK 73.6 amp (at 20Hr)	24.3
EXIDE-GNB 60 amp (at 20Hr)	19.8
EXIDE-GNB 70 amp (at 20Hr)	23.0

### 5.4 CRUTCH HOLDER

Rear Frame mount Fig 5.15

Rear Seat mount Fig 5.16

#### **WARNING!**

- Ensure that the crutch is securely fastened to the crutch holder.
- Ensure that the crutch is not interfering with the mechanisms of the scooter.
- Ensure that the crutch does not protrude from the scooter.
- Do not attempt to remove the crutch whilst the scooter is in motion.
- Always come to a complete stop and turn off the power to the controls before attempting to remove the crutch. This will avoid accidentally operating the scooter.

### 5.5 LIGHTS AND INDICATORS,

Front Fig.5.17

Rear Fig 5.18

Ensure that the lights and indicators are functioning correctly and lenses are clean before going outdoors at night or in poor visibility.

**NOTE :** The light clusters fitted to the scooter comprise of LED lights. They are very efficient and reliable, which means that there is no "bulb" to change. Should a light cluster become damaged, please contact your local Sunrise medical approved servicing agent for any warranty, service or repair work required.

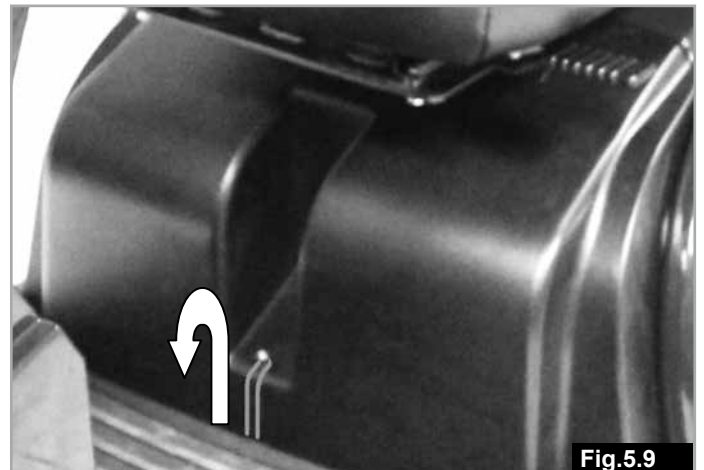

Fig.5.9



Fig.5.10

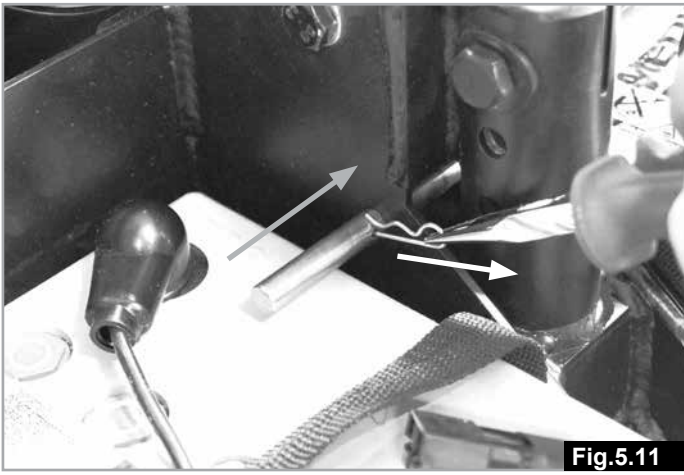

Fig.5.11



Fig.5.15



Fig.5.12



Fig.5.16



Fig.5.13



Fig.5.17



Fig.5.14



Fig.5.18

### 5.6 POWER USB OUTLET 5V- D.C.

This socket provides a convenient d.c. 5V - 1.2A power supply to run low-current external accessories such as phone chargers etc. (Fig.5.19).

#### **WARNING!**

Do not connect appliances that exceed the current rating of the power outlet socket. The power will be cut if 1.2A is exceeded, but will automatically be restored when the abnormal current load is removed.

### 5.7 RAISED FOOT PLATFORM

This is to facilitate the correct knee / leg angle to obtain maximum comfort for users with shorter lower leg lengths, (Fig.5.20).

#### **WARNING!**

Be aware of the extra height from the ground and take care when getting on and off the scooter.

### 5.8 EXTENDED BACK REST

This option offers extra support and comfort to the upper back and shoulders. It is particularly suited to taller users, (Fig 5.21).



Fig.5.19



Fig.5.20



Fig.5.21

### 5.9 HEAD REST

The crash tested head rest offers additional support and comfort to the back of the head, neck and shoulders, (Fig.5.22).

### 5.10 REAR UNIVERSAL MOUNT

This mount is used for the rear storage box, but it can also be used as a base to strap small items of luggage to, (Fig.5.23).

#### **WARNING!**

- Maximum Carrying Load = 10kg.
- The weight of the driver plus any luggage, should not exceed the maximum user weight of the scooter.

### 5.11 REAR BASKET WITH HANDLE

This option extends the luggage/shopping carrying capacity of the scooter. It is detachable and has a handy carrying handle, (Fig.5.24).

#### **WARNING!**

- Maximum Storage load = 5kg.
- The weight of the driver plus any luggage, should not exceed the maximum user weight of the scooter.



**Fig.5.22**



**Fig.5.23**



**Fig.5.24**

### 5.12 REAR STORAGE BOX

This option offers a greater degree of weather protection and security for items such as wet weather clothing, shopping, personal items etc.

When locked the storage box cannot be opened and it cannot be removed from the scooter. When unlocked the storage box can be accessed and if required removed from the scooter with the press of a button, (Fig.5.25).

#### **WARNING!**

- Maximum Storage load = 10kg.
- The weight of the driver plus any luggage, should not exceed the maximum user weight of the scooter.

### 5.13 FOOT CONTROL

This can be mounted anywhere on the floor of the scooter or on the raised foot platform. It is used in conjunction with either a twist grip or a side lever control. Two switches are also used, one to switch between forwards and reverse and one to switch between the foot control and the twist grip or side lever control, (Fig.5.26). Also see section 7.12 and 7.13.

#### **WARNING!**

Accidental depression of the pedal while the scooter is switched on, will cause the scooter to move. Exercise caution and always turn the scooter off when not driving.

### 5.14 TWIST GRIP THROTTLE

The twist grip control may be used on its own or in conjunction with the foot control. If it is used on its own, it has a forward/reverse switch supplied. If the twist grip is used in conjunction with the foot control, two switches are used, forwards/reverse and an additional switch to select each control, (Fig.5.27). Also see section 7.12 and 7.13.

### 5.15 ANGLE ADJUSTABLE FOOT SUPPORT

The foot support helps to provide extra support for the foot, ankle and leg, helping to prevent cramp and reducing joint pain. It can be mounted anywhere on the floor of the scooter or on the raised foot platform, (Fig.5.28).



**Fig.5.25**

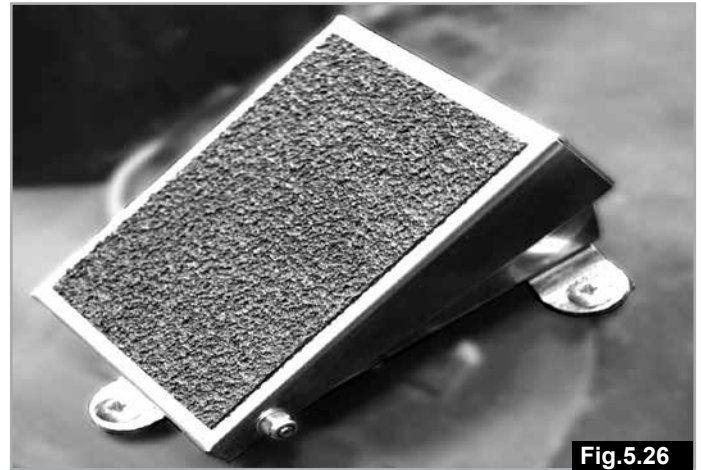

**Fig.5.26**



**Fig.5.27**



**Fig.5.28**

### 5.16 POWERED SEAT LIFT

This device is an aid to lifestyle. It can assist the user to reach for objects without the need for standing, when shopping for example or approaching a counter such as an airport check in.

It is controlled from a switch mounted beneath the seat, (Fig.5.29).

#### **WARNING!**

- When the seat lift is raised the stability of the scooter is affected.
- Do not over-reach from the scooter seat.
- Do not operate the seat lift on significant inclines.
- Do not operate the freewheel device.
- Watch out for overhanging obstacles, (such as kitchen cupboards), when operating the seat lift.
- Be vigilant. Watch out for small children and pets etc. when operating the seat lift.
- To prevent falls it is recommended that the arm rests are in the down position when using the seat lift.
- For your safety when the seat lift is in operation, all powered movement is stopped. Returning the seat to the normal position will reinstate full drive.
- As with all moving parts, be aware of the possibility of finger entrapment.

### 5.17 MANUAL ARTICULATING LEG REST (ALR)

This accessory offers extended seating and positioning possibilities. It is designed for users who need more flexible control and support for legs and feet, (Fig.5.30).

### 5.18 AMPUTEE SUPPORT

This provides extra support for amputees, in the form of a comfortable and stable platform. It is fully adjustable to allow accurate positioning to suit users on an individual basis, (Fig.5.31).

### 5.19 ARMREST HEIGHT ADJUSTABLE BRACKET

An additional bracket to provide a height adjustment option to the angle adjustable arm rests, (Fig.5.32).



Fig.5.29



Fig.5.30



Fig.5.31



Fig.5.32

### 5.20 REAR VIEW MIRROR

The mirror is fully adjustable and mounted on the handlebars. There are two types, left hand mount and right hand mount, (Fig 5.33).

### 5.21 WALKER - ROLLATOR MOUNT

This rear mounted frame allows the carriage of Sunrise Medical walkers and rollators on board the scooter, (Fig.5.34).

#### WARNING!

- Be aware that attached accessories increase the effective footprint of the scooter.
- Take extra care when manoeuvring if you have a rollator or walker on board.
- Ensure that the load is secured properly before moving off.
- Be aware that the load you are carrying may obscure the rear lights on the scooter. If this is the case, please use the foot path whilst carrying the load, particularly at night.

### 5.22 OXYGEN BOTTLE HOLDER

There are two diameters, 100 and 120mm. Both fit to the seat via the arm rest bracket bolts. Both can be positioned on the left or right hand side of the seat. The holder is designed to accept a 3.9 kg bottle, (Fig.5.35).

#### WARNING!

While you are taking Oxygen, observe all safety regulations pertaining to the use of Oxygen.

- Do not enter an area where naked flames may be used.
- Do not smoke.
- Do not use transmitting devices such as mobile phones etc.

### 5.23 FULL FRONT BUMPER

This fully enclosed front bumper is available as an option, (Fig.5.36).



Fig.5.33



Fig.5.34



Fig.5.35

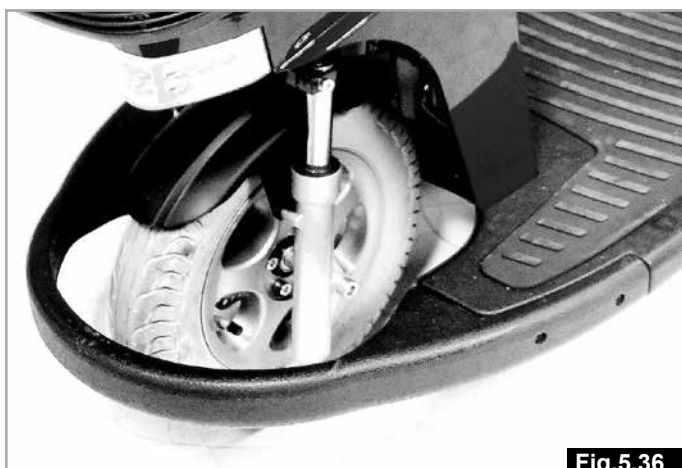

Fig.5.36

## 5.24 FRONT CORNER BUMPERS

The corner bumpers are fitted as standard, (Fig.5.37).

## 5.25 SOLID TYRES

Solid tyres are available as an option.

The solid tyres offer greater security for the user because they cannot be punctured.

**NOTE:** Solid tyres have the effect of producing a firmer ride, (Fig.5.38).

## 5.26 WINDSHIELD (NO PHOTO).

### **WARNING!**

- Do not bend the windshield.
- Do not expose the windshield to heavy impacts.
- Keep the windshield clean using warm soapy water, so that your view is not impeded.
- If the rubber surround strip is damaged or missing, replace it as soon as possible.



## 6.0 Using The Scooter

### **WARNING!**

- Parts of the scooter are heavy. Please use correct lifting techniques.
- If you are unsure about lifting or removing any assemblies, or performing any other task requiring physical effort, get someone to help you who can manage the task or call your local Sunrise Medical dealer.

### **6.1 PREPARING FOR STOWED TRANSPORTATION:**

Remove the batteries as described in section 5.3.

To lift the batteries please use the handles on the webbing cradle surrounding the batteries.

Ensure that the seat is removed, (section 5.0) or folded and the tiller is folded in it's lowest position.

### **6.2 TO USE THE SCOOTER AGAIN:**

Reverse the above procedure

Refit the batteries.

### **WARNING!**

- Never lift the scooter by the armrests, seat or tiller, harm could be done to the user or to the scooter.

### **6.3 SEAT BACKREST RECLINE**

#### **WARNING!**

- Take care when adjusting the seat backrest recline angle as it could be possible to fall backwards and harm the user or the scooter.
- When adjusting the back angle, be careful not to get your fingers caught.

The seat backrest recline angle is adjusted by the lever shown in Fig 6.1.

### **6.4 SEAT BACKREST LUMBAR**

If fitted your scooter may have an optional backrest lumbar adjustment. (Fig 6.2)

This is adjusted by rotating the knob located behind the armrest on the left hand side of the scooter. Rotate the knob in the direction shown on the arrow to increase the lumbar support. The lumbar support increases, and then decreases as the knob is rotated in the direction show.



### 6.5 SEAT POSITION

The scooter seat can be adjusted in a forward or backwards position. The adjustment lever is found on the right hand side under the front of the seat. Pull the lever upwards and use legs and body to move to the required position and release lever, (Fig.6.3).

### 6.6 ARMREST ANGLE

The scooter armrests are angle adjustable for user comfort. The adjustment knob (1) is found under the armrest body. The knob is rotated either way to increase or decrease the angle of the armrest, (Fig.6.4).

### 6.7 TILLER ADJUSTMENT

#### DANGER!

- Do not adjust the tiller while the scooter is being driven as serious injury could happen if you lose control.
- Do not use the tiller adjustment handle to hold or carry items such as bags etc.
- Ensure fingers or other items are not around the area of the lower tiller when making adjustments. Serious injury could happen due to entrapment.

The angle of the tiller can be adjusted for getting on and off the scooter and for achieving a comfortable driving position.

1. Rotate the lever clockwise.
2. Hold the handlebar and push or pull the tiller to the required position.

The tiller contains a gas strut to aid in the adjustment of the tiller position, (Fig.6.5).



Fig.6.2



Fig.6.3



Fig.6.1

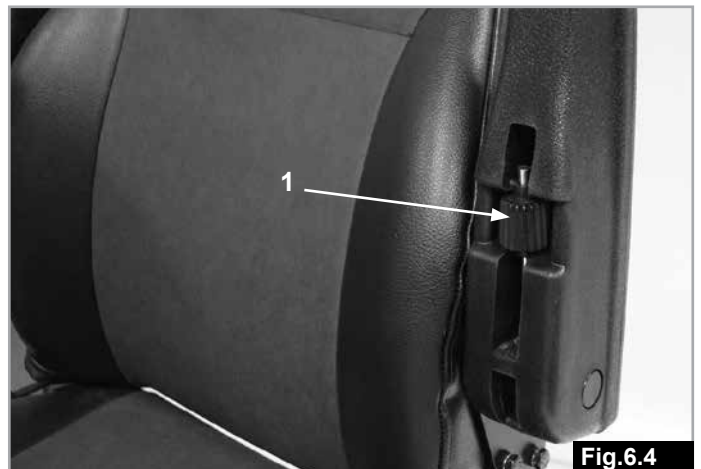

Fig.6.4



Fig.6.5

## 6.8 ELITE<sup>2</sup> XS, RS DELTA HANDLEBAR ADJUSTMENT

### ⚠ CAUTION!

The Elite<sup>2</sup> delta handlebar angle can be adjusted to suit the users needs, (Fig 6.6). The handlebar is clamped within the control system.

Your dealer or supplier can adjust the angle of the handlebar if needed. Do not attempt adjustment of this yourself. Damage to the control system of the scooter could happen if unauthorized adjustment is carried out.

## 6.9 ELITE<sup>2</sup> PLUS HANDLEBAR ADJUSTMENT

### ⚠ CAUTION!

- The Elite<sup>2</sup> PLUS handlebar angle can be adjusted to suit the users needs, (Fig 6.7). The handlebar is clamped within the control system
- Your dealer or supplier can adjust the angle of the handlebar if needed. Do not attempt adjustment of this yourself. Damage to the control system of the scooter could happen if unauthorized adjustment is carried out.



Fig.6.6



Fig.6.7

## 6.10 SLOPES

Please also refer to section 4.20.

The following instructions explain how to manoeuvre correctly on steep ramps and slopes, especially in the course of descent, (Fig 6.8).

### ⚠ DANGER!

- Low speed settings are recommended when traveling on slopes, particularly in reverse.
- We strongly recommend that you bring the seating backrest into an upright position during manoeuvres on slopes.
- If you stop on an incline, start off slowly and, if necessary, lean forward to counteract the tendency of the front wheel to rise.
- On descents it is important not to allow the scooter to exceed normal speed. Indeed, the safest course is to go down steep hills slowly and to stop immediately if you have any doubts about the steering.
- If the scooter gathers speed, release the control lever to slow down, or stop completely.
- Start off again slowly and do not allow speed to increase.
- Make sure the scooter is in drive mode as this ensures that the automatic braking system is active.
- Climbing or descending a slope with the automatic brakes disengaged is very dangerous and is not recommended.
- Always reduce your speed when turning corners, particularly when travelling down slopes.
- Disregarding this advice could lead to your Scooter tipping over.
- Do not traverse across the face of a slope in excess of 10° (1 in 6).
- Disregarding this advice could result in your Scooter tipping.

## 6.11 SLOPE CLIMBING

(Fig 6.8).

- Where possible always travel up slopes or ramps directly facing the slope of the hill.
- When driving up or down a very long hill, it is a good idea to rest for a moment to break the journey up. This will aid performance and allow the scooter motor to cool down.
- Do not traverse across the face of a slope, in excess of 10° (1 in 6).
- Always reduce your speed to the minimum setting when reversing down hills.
- Do not attempt to drive along with the wheels at different levels, e.g. along the footpath and road simultaneously.

## 6.12 FREEWHEEL DEVICE

**⚠ DANGER!**

Please also refer to section 4.7

- Do not sit on the scooter when freewheel mode is activated.
- Do not attempt to drive the scooter when freewheel mode is active.
- Never allow the scooter to be pushed in freewheel mode by other persons when you are still on board.
- Do not activate freewheel mode when the scooter is stopped or parked on a significant slope.
- Never attempt to activate freewheel mode whilst you are still on board the scooter.

Pull the lever down so that it is in the freewheel position. The drive wheels will turn freely. If you wish to push the scooter with the motors off, you should follow this procedure. When the levers are pushed upwards, the drive wheels will automatically connect with the propulsion mechanism, (Fig.6.9).

## 6.13. TYRE PRESSURE:

It is important to check inflation pressure regularly, along with the state of wear of the tyres.

The maximum pressure recommended for the wheels should be up to :

- Elite2 XS & RS = 1.8-2.0 bar (25-28 P.S.I.)
- Elite2 Plus = 2.4-2.5 bar (33-35 P.S.I.)

For further information on tyres please refer to section 18.2 and 18.3.

**⚠ DANGER!**

Never inflate the tyres with a service station air pump. It is recommended that you use a manual pump or a pressure regulator (manometer).

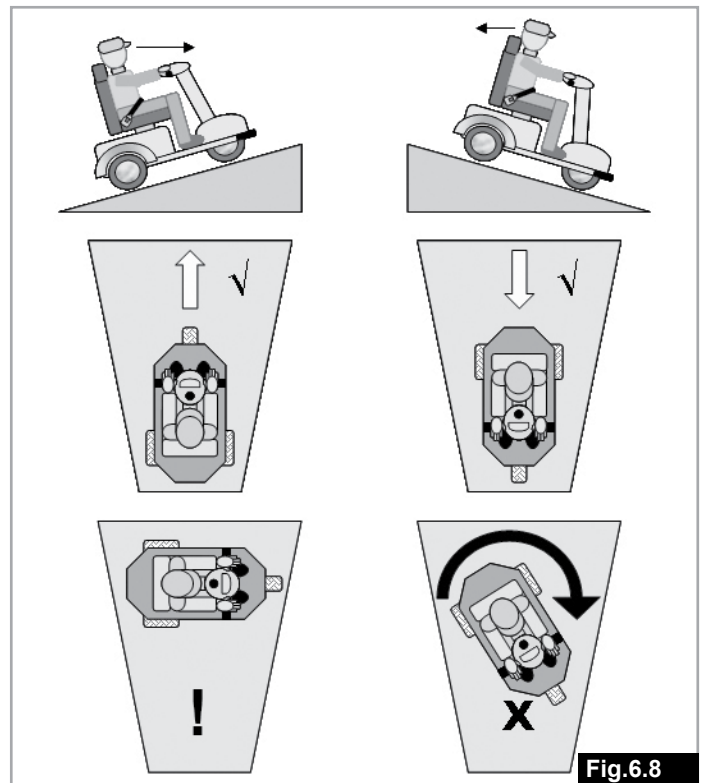

Fig.6.8



Fig.6.9

### 6.14 MOUNTING A KERB OR STEP

The Scooter is capable of mounting and dismounting kerbs and obstacles up to 100mm (4").

Remember when climbing kerbs to drive forwards and face the kerb at 90°, (Fig.6.10).

Approach the kerb or step from a minimum of 500mm, select a medium to high speed setting and drive up without stopping.

Leaning forwards will also help maximize your stability.

**NOTE:** Heavier users will require higher speed settings

#### **WARNING!**

- The approach speed and process can vary depending on your scooter performance and wheel type.
- Drastically under inflated tyres can cause loss of control when mounting kerbs and damage the scooter.

### 6.15 DISMOUNTING A KERB OR STEP

To dismount a kerb, face the kerb at 90°, but select a low speed setting.

Move forward and slowly allow your Scooter to drop gently, front wheel(s) first from the kerb.

The rear stabilising wheels may make contact with the kerb when dismounting this is normal, (Fig.6.11).

### 6.16 USING NEAR WATER

Take extra care when using your scooter near open water. Canal tow paths, beaches, quay sides and river banks can be hazardous.

#### **DANGER!**

- Do not travel along a sloping surface leading to an open waters edge.
- Keep a distance of at least one scooter length from an open waters edge whenever possible.
- Beware of hidden obstacles such as tree roots drain covers and mooring rings as these may cause loss of control if you hit them unexpectedly.
- Use a low speed setting.
- Never reverse towards open water.
- Do not drive up or down steep slopes located near an open waters edge.
- Give way to pedestrians on canal tow paths and footpaths.
- Sound the horn to let other people know you are there.
- Never try to manoeuvre around pedestrians if it takes you too close to the waters edge.
- Avoid deep sand, gravel, mud and wet grassy slopes.
- Take extra care on windy days as loose clothing such as capes or blankets can suddenly fly up and may foul the controls or temporarily block your view.
- Do not get close to open water during a storm.
- When stationary, switch the scooter OFF at the key.
- Observe all local by laws, rules and regulations.

#### **CAUTION!**

- Always clean your scooter thoroughly if it has been exposed to mud, sand, salt or other contaminants.
- Do not use a high pressure washer, (see section 11).

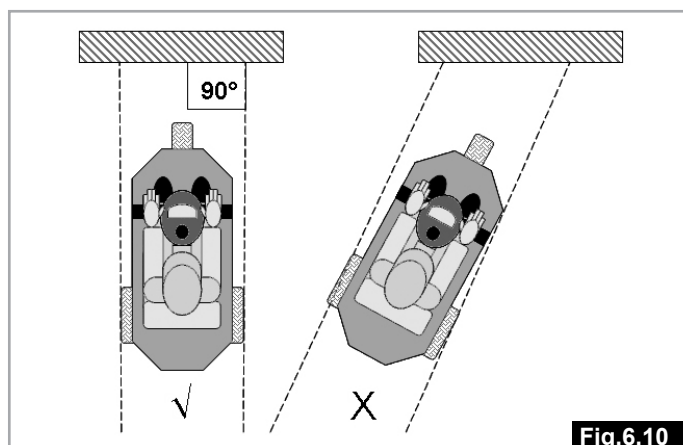

Fig.6.10

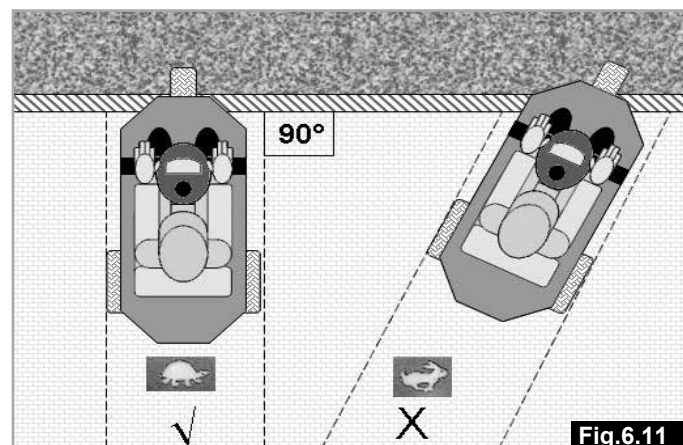
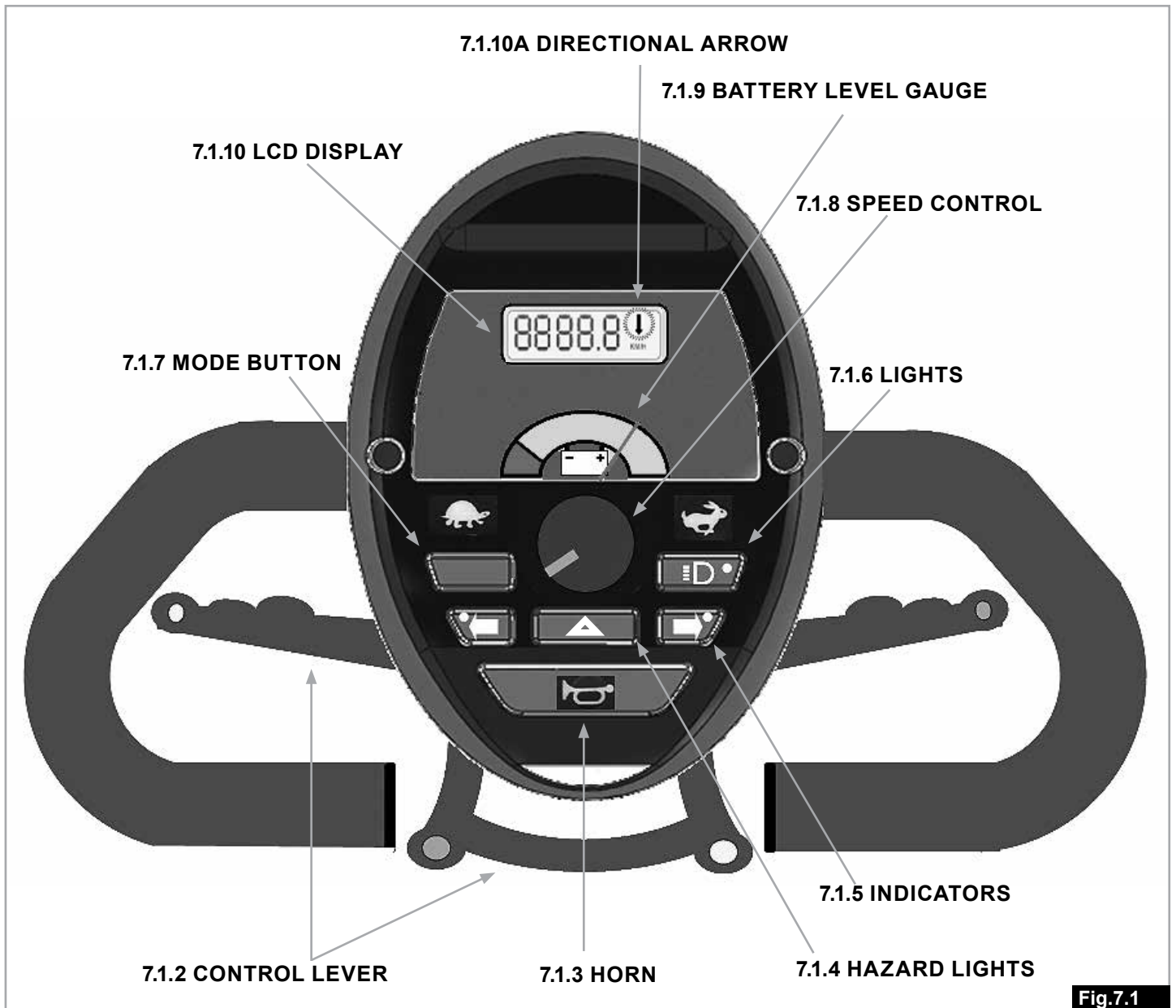

Fig.6.11

**7.0 Scooter Control System**

**7.1 ELITE<sup>2</sup> XS, RS CONTROL SYSTEM**



**Fig.7.1**

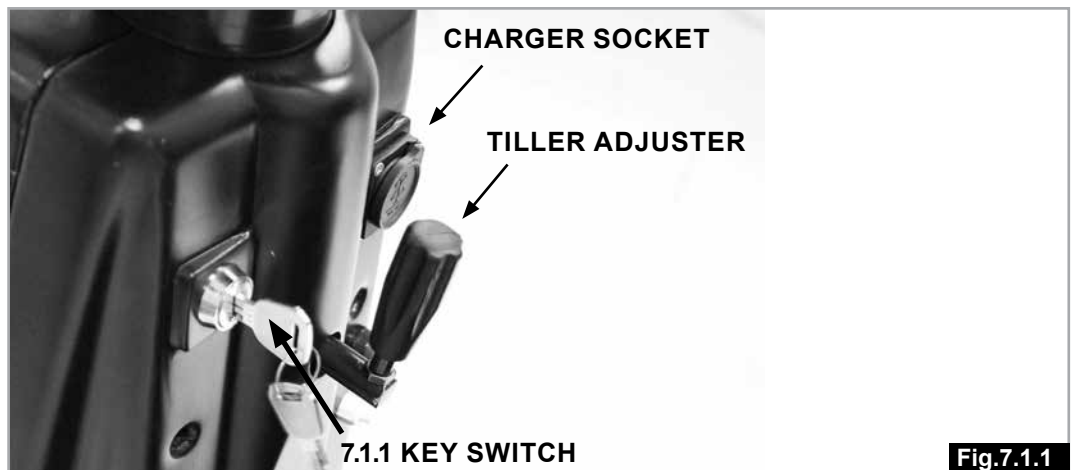

**Fig.7.1.1**

Please refer to Fig.7.1- Fig.7.1.1 - Fig.7.1.2 - Fig.7.1.3

### 7.1.1 ON/OFF KEY SWITCH

The On/Off key switch applies power to the control system electronics, which in turn supply power to the scooter motors.

- To turn ON Insert the key vertically and turn 90 degree clockwise.
- To turn OFF scooter, turn key back to vertical position and remove, (Fig.7.1.1).

#### **WARNING!**

- Do not use the on/off key switch to stop the scooter unless there is an emergency. (If you do you may shorten the life of the scooter drive components).
- To avoid unexpected or unintentional movement of the scooter and to conserve battery power, it is recommended that the keyswitch is switched Off when stationary or not being used.

### 7.1.2 CONTROL LEVER (WIG WAG)

Located by handle bar grips. Your speed as well as forward and reverse motion is controlled via the control lever or wig wag.

Gently pull with the right hand or push with the left thumb to move the scooter in a forward motion. The amount of movement applied to the lever or wigwag also proportionally controls the speed of the scooter.

The left hand or right thumb moves the Elite2 in a reverse motion and also controls the speed of the scooter in reverse.

The lever will return by itself when released, and you will stop gently.

Braking is engaged when the Wig-Wag is released.

#### **WARNING!**

The factory default setting is described above. Be aware that it is possible the throttle operation could be reversed through programming, particularly if you are a second user.

When stopping the high visibility rear LED braking lights will illuminate. These also function when the scooter lights are turned on.

When reversing an audible alarm can be programmed to come on to warn other vehicles or pedestrians that the scooter is reversing.

**NOTE:** The audible reversing alarm is turned off by default but it can be activated by your Sunrise Medical dealer or supplier. It is not recommended to deactivate this feature if it is a statutory requirement of your country/ state.

**NOTE:** Forward and reverse functions can be swapped over from right hand operation to left hand operation, via programming. Please consult your authorised Sunrise dealer.

**NOTE:** The handle bar angle can be adjusted to the most comfortable position by your local authorised Sunrise dealer.

#### **WARNING!**

It is important that you stop the scooter before you change direction from forward to reverse. Always turn the scooter control system off via the keyswitch before you transfer in or out of the scooter.

### 7.1.3 HORN

The horn will sound while this button is depressed.

### 7.1.4 HAZARD LIGHTS

With the scooter ON the front and rear LED indicators will flash simultaneously when this button is pressed.

The visual indicators on the direction buttons on the keypads will also illuminate.

Press the button again to switch the hazard lights off.

### 7.1.5 INDICATORS

Pressing the button will illuminate the front and rear LED indicators in a flashing pattern indicating you are turning the scooter. On the keypad the visual indicator light will also flash, and the scooter will emit a beeping tone.

To turn off the indicators press the button again.

Alternatively the direction indicators will automatically turn off after a distance of approximately 30 meters.

### 7.1.6 LIGHTS

Pressing the button will turn on the front LED headlight, and the rear LED lights

**NOTE:** If the lights are inadvertently left on after use, removing the ON/OFF key will extinguish the lights automatically.

#### **WARNING!**

Ensure that the lights and indicators are functioning correctly and all of the lenses are clean, before using the scooter at night or during poor visibility.

### 7.1.7 MODE BUTTON

Pressing the Mode button will change the information shown in the LCD display 7.1.10

- Pressing and HOLDING the Mode button will reset the trip distance displayed.
- Press once to show total distance travelled.
- Press twice to show total trip distance travelled ( LCD will display a “t”).
- Press a third time to show total hours of use.
- Press fourth time to return to speed display.

### 7.1.8 SPEED CONTROL

This allows you to preset your desired scooter speed. Turn the dial anti-clockwise to slow for very gentle operation. Turn it clockwise to increase your speed to maximum

Remember that only with practice will you become a competent driver. Find a safe, hazard free environment to practice controlling the scooter and familiarise yourself with the controls and functions.

#### **WARNING!**

For the safety of the operator and other pedestrians, Sunrise Medical recommends that whilst driving on footpaths and other pedestrian walk ways, the scooter preset speed should be set to less than 4 mph/6kph.

### 7.1.9 BATTERY LEVEL

This indicates the average amount of charge you have in the batteries. Green indicates fully charged batteries with reducing charge to the red indicator. Red indicates warning and less than half-charged batteries, (Label.7.1.9). Please be aware that the meter reading will fluctuate when accelerating from start or travelling uphill, this is normal. The reading is more accurate when the scooter is operating on flat level ground.

### 7.1.10 LCD DISPLAY (7.1.10)

The backlit LCD display can display:

- Speed in Kilometres per hour (km/h) or Miles per hour (m/h).
- Total distance in Kilometres (km) or Miles (m),
- Trip distance – reset by holding down MODE button, 7.1.7, (Fig.7.1).
- Total Hours the scooter has been used (h).
- Fault display – see troubleshooting section.

When used with an optional foot or twist grip hand control the flashing arrow indicates travel in reverse direction, (Fig 7.1-Label 7.1.10A), (also see section 7.13).

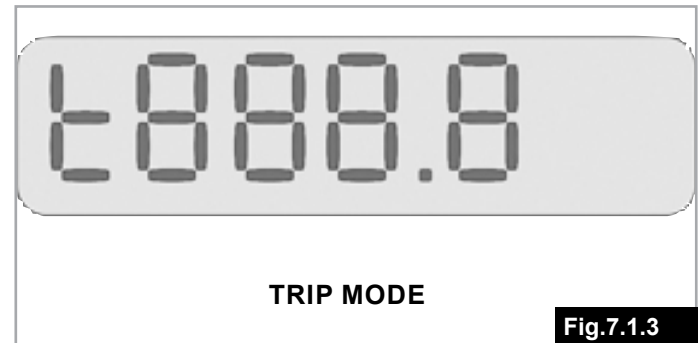

7.2 ELITE<sup>2</sup> PLUS OPTIONAL CONTROL SYSTEM – FIG 7.2

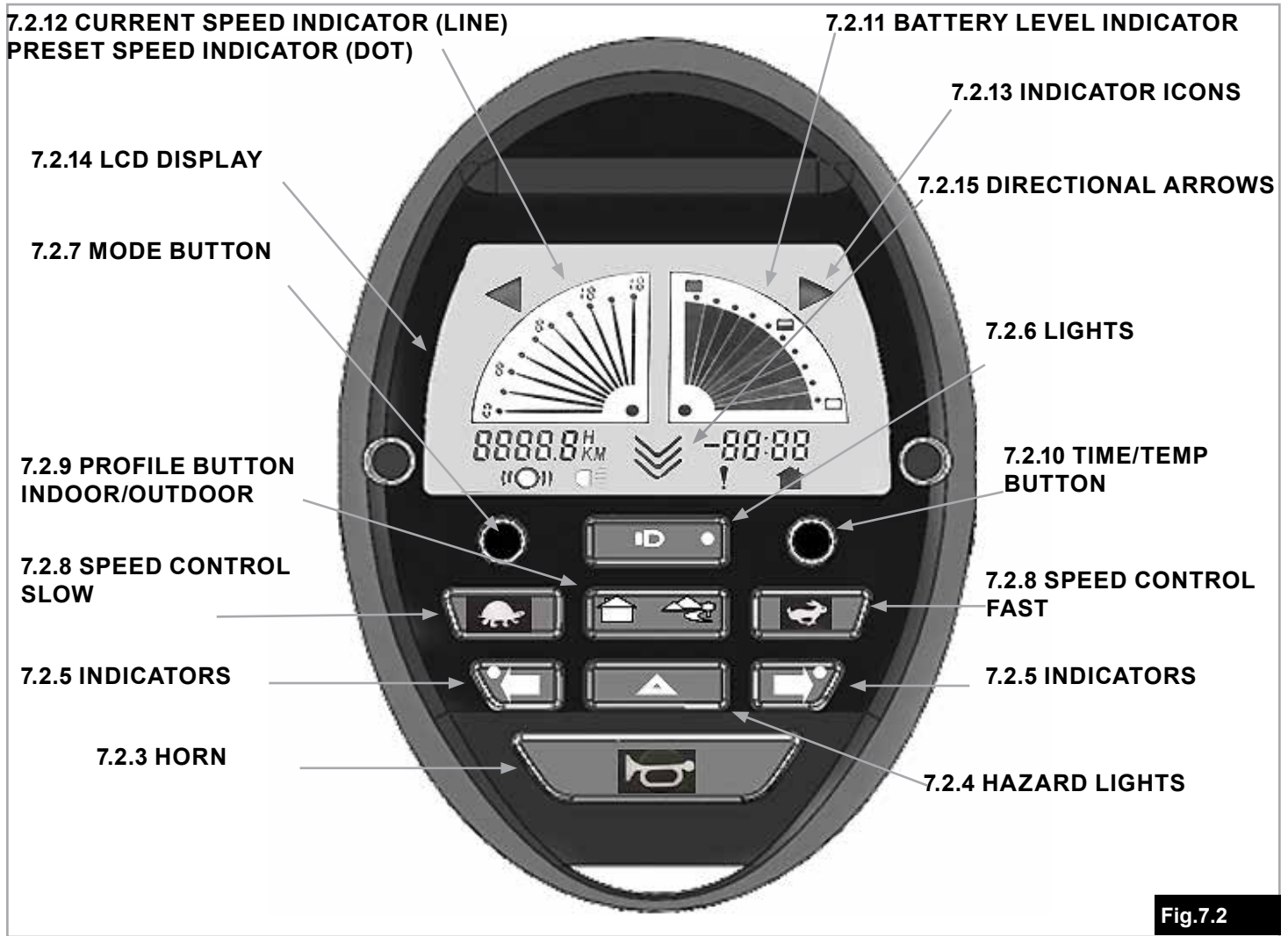

Fig.7.2

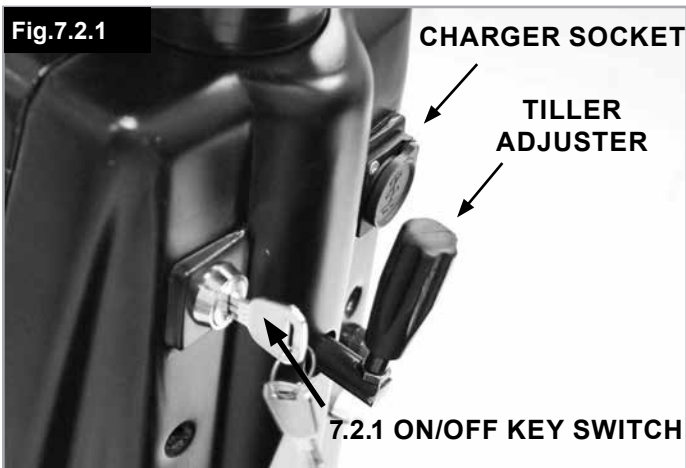

Fig.7.2.3

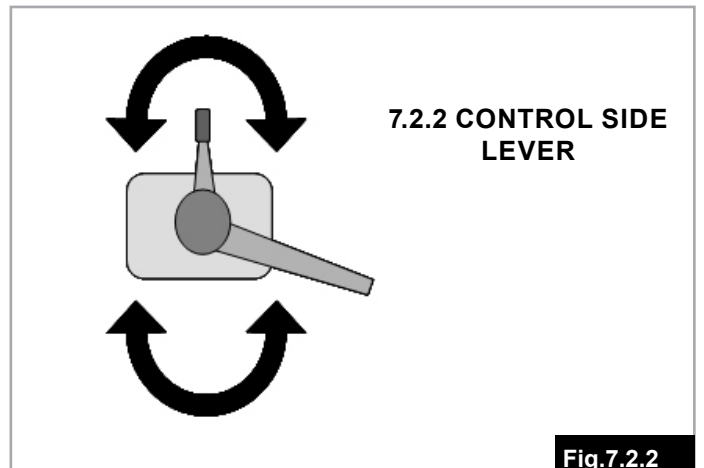

Fig.7.2.2

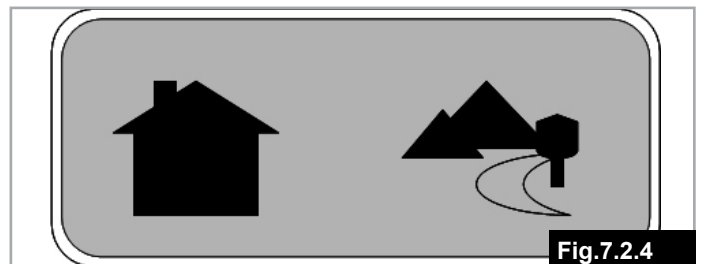

Fig.7.2.4



Please refer to Fig.7.2- Fig.7.2.1 - Fig.7.2.2 - Fig.7.2.3 - Fig.7.2.4 - Fig.7.2.5

### 7.2.1 ON/OFF KEY SWITCH

The On/Off key switch applies power to the control system electronics, which in turn supply power to the scooter motors.

To turn ON Insert the key vertically and turn 90 degree clockwise.

To turn OFF scooter, turn key back to vertical position and remove, (Fig.7.2.1).

#### **WARNING!**

- Do not use the on/off key switch to stop the scooter unless there is an emergency. (If you do you may shorten the life of the scooter drive components).
- To avoid unexpected or unintentional movement of the scooter and to conserve battery power, it is recommended that the key switch is switched Off when stationary or not being used.

### 7.2.2 CONTROL LEVER (SIDE THROTTLE)

Located by handle bar grips. Your speed as well as forward and reverse motion is controlled via the control lever or side throttle.

Gently pull up on the lever to move the scooter in a forward motion. The amount of movement applied to the lever also proportionally controls the speed of the scooter.

Pushing down on the knob at the top of the lever will move the scooter in reverse and also proportionally controls the speed of the scooter in reverse.

Alternatively pushing down on the lever will also move the scooter backwards. Again the rate of speed is controlled by the amount of the movement of the lever. The lever will return by itself when released, and you will stop gently. Braking is engaged when the lever is released

When stopping the high visibility rear LED braking lights will illuminate. These also function when the scooter lights are turned on.

A programmable audible reversing alarm is available to warn other vehicles or pedestrians when you are reversing.

**NOTE:** The audible reversing alarm is turned off by default but it can be activated by your Sunrise Medical dealer or supplier. It is not recommended to deactivate this feature if it is a statutory requirement of your country/state.

**NOTE:** The control lever can be mounted on either side of the handle bars.

#### **WARNING!**

It is important that you stop the scooter before you change direction from forward to reverse. Always turn the scooter control system off via the keyswitch before you transfer in or out of the scooter.

### 7.2.3 HORN

The horn will sound while this button is depressed.

### 7.2.4 HAZARD LIGHTS

With the scooter ON the front and rear LED indicators will flash simultaneously when this button is pressed.

The corresponding indicator icons on the LCD will also illuminate, (7.2.13).

Press the button again to switch the hazard lights off.

### 7.2.5 INDICATORS

Pressing the button will illuminate the front and rear LED indicators in a flashing pattern indicating you are turning the scooter. The corresponding indicator icons on the LCD will also illuminate, (7.2.13), and the scooter will emit a beeping tone.

To turn off the indicators press the button again.

Alternatively the direction indicators will automatically turn off after a distance of approximately 30 meters.

### 7.2.6 LIGHTS

Pressing the button will turn on the front LED headlight, and the rear LED lights

**NOTE:** If the lights are inadvertently left on after use, removing the ON/OFF key will extinguish the lights automatically.

#### **WARNING!**

Ensure that the lights and indicators are functioning correctly and all of the lenses are clean, before using the scooter at night or during poor visibility.

### 7.2.7 MODE BUTTON

Pressing the Mode button will change the information shown in the LCD display 7.2.14

- Pressing and HOLDING the Mode button will reset the trip distance displayed.
- Press once to show total distance travelled.
- Press twice to show total trip distance travelled ( LCD will display a **t**).
- Press third time to show total hours of use.
- Press fourth time to return to normal display.

### 7.2.8 SPEED CONTROL

This allows you to preset your desired scooter speed. Pressing the button marked with a Rabbit increases preset speed, this is shown by the increasing dots in the left hand part of the display, (7.2.12).

Pressing the button marked with a Turtle decreases speed, this is shown by the reducing dots in the left hand part of the display, (7.2.12).

**NOTE:** Remember that only with practice will you become a competent driver. Find a safe, hazard free environment to practice controlling the scooter and familiarise yourself with the controls and functions.

### **WARNING!**

For the safety of the operator and other pedestrians, Sunrise Medical recommends that whilst driving on footpaths and other pedestrian walk ways, the scooter preset speed should be set to less than 4 mph/6kph.

### 7.2.9 USER PROFILE – INDOOR / OUTDOOR BUTTON

The user profile button, (indoor/outdoor mode), changes the speed of the scooter to a preset 50% of maximum speed and reduces the acceleration and deceleration. This is ideal when travelling indoor or within confined spaces.

When the indoor mode is activated:-

The LCD display will show the graphic in Fig 7.2.3

To return to normal driving, (outdoor mode), press the button again, (Fig.7.2.4).

When the indoor mode is active, the scooter speed can also be reduced further by using the Turtle button as normal. The scooter will remember this speed when changing from indoor/outdoor mode until the scooter is turned off. After this the setting will revert to the standard 50% setting.

**NOTE:** Further adjustment of the standard indoor setting is possible.

Contact your Sunrise Medical dealer or supplier to do this.

### 7.2.10 TIME / TEMPERATURE

Each press of this button will change the display to show either the time or the current ambient temperature.

**NOTE:** The ambient temperature display is an indication only of current ambient temperature. Due to the numerous factors that affect temperature sensing, the displayed temperature should only be taken as a guide.

### 7.2.11 BATTERY GAUGE

This indicates the average amount of charge you have in the batteries. 10 bars indicates fully charged batteries this is shown by the full battery symbol. 50% charge is approximately 5 bars. The battery gauge will flash when the batteries are in a very low state of charge. It is recommend that, if possible, you charge the scooter when the gauge displays 2 bars, (see section 9). Please be aware that the meter reading may fluctuate when the scooter is in use, this is normal.

### 7.2.12 SPEED DISPLAY ICON

The straight line indicates the current running speed and will rise and fall accordingly.

The small dots represent the preset speed setting, (please see 7.2.8 and Fig. 7.2).

### 7.2.13 INDICATOR DISPLAY ICONS

The triangular shaped icon will pulse in time with the indicators and hazard lights, (please see 7.2.4, 7.2.5 and Fig 7.2).

### 7.2.14 LCD DISPLAY

(Fig.7.2)

The backlit LCD display can display the following functions:













- Battery gauge.
- Time and ambient temperature.
- Speed in Kilometres per hour (km/h) or Miles per hour (m/h),
- Total distance in Kilometres (km) or Miles (m),
- Trip distance. This can be reset by holding down the MODE button.
- Total Hours the scooter has been in use (h).
- Directional Arrows. When used with an optional foot or twist grip hand control the arrow indicates travel in reverse direction, (see section 7.13).
- Fault display, (see troubleshooting section).

### 7.2.15 DIRECTIONAL ARROWS

When used with an optional foot or twist grip hand control the arrow indicates the direction of travel.

### 7.3 CLOCK SETTING

To set the clock please follow the instructions in Fig.7.2.5. Overleaf.

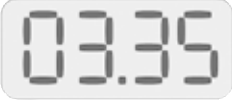
MODE	OPERATION		DISPLAY	
<b>To enter Clock Set Mode</b>	Press and hold the round button below the clock display for more than 10 seconds.		The current time display flashes.	
<b>Choosing the 12 or 24 Hour Clock Mode</b>	Press and release the right-hand indicator button to switch between 12 or 24 hour clock display.		12:hr Flashes or 24:hr Flashes.	
	Press and release the round button to confirm your selection and move to the next step.		The hours part of the time display flashes.	
<b>Setting the Hours</b>	Press and release the right-hand indicator button once to move up One Hour at a time.		The Hour display is changed by 1 hour per press and release.	
	Press and release the round button to confirm the hours setting and move to the next step.		The minutes part of the time display flashes.	
<b>Setting the Minutes</b>	Press and release the right-hand indicator button once to move up One Minute at a time.		The Minutes display is changed by 1 minute per press and release.	
<b>To Finish</b>	Press and release the round button to confirm the minutes setting. This will automatically save your settings and exit the Clock Set Mode.		The clock shows your new time setting.	

**Fig.7.2.5**

## 7.4 CHARGING SOCKET:

### **WARNING!**

- The charging socket should only be used for connecting the scooter battery charger plug to the scooter.
- The charging socket should not be used to supply power for any other device.
- Connection of unapproved electrical devices may damage the control system or compromise the EMC performance of the scooter.
- Always put the socket cover back over the charging socket when the battery charger plug has been removed.  
(Fig. 7.4.1)

Please see section 9.0 for more details about charging.

## 7.5 PROGRAMMING SOCKET

When the scooter leaves the factory, the parameters of the controller are set to accommodate most driving styles and preferences. However the scooter control system is very versatile and will allow certain functions to be reprogrammed.

If required, the programming socket. (Fig. 7.5.1), will enable an approved Sunrise Medical authorised dealer to reprogramme your scooter.

Your approved Sunrise Medical authorised dealer can also gain useful service information via the programming socket, from the scooter's on board diagnostics facility. To programme the controller a special programming device is required, (handheld or PC software), which is available to your Sunrise Medical authorised dealer.

### **DANGER!**

- Programming the scooter is only allowed via authorised personnel trained by Sunrise Medical.
- Incorrect controller settings could cause driving outside the safe limits and could result in damage or injury.

**NOTE:** Sunrise Medical does not accept responsibility for damages / injuries which result from unexpected movement or stopping of the scooter due to inappropriate programming or unauthorised use of the scooter.



Fig.7.4.1

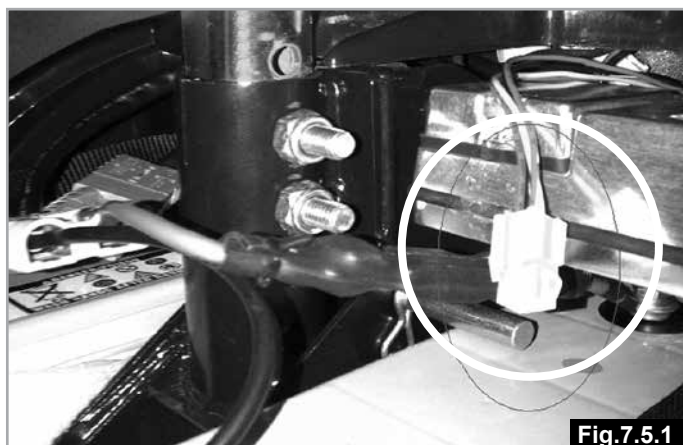

Fig.7.5.1

## 7.6 OPERATING THE CONTROLS

If you are new to driving a scooter, it is a good idea to practice in a clear, safe space on a sound level surface. Put the key in its slot, but do not turn the scooter on. Board the scooter by following the instructions in section 4.18.

## 7.7 BASIC DRIVING ELITE<sup>2</sup> XS, RS AND PLUS

Make sure you are properly seated and can comfortably reach all the controls on the scooter.

1. Set the speed control to its lowest speed.
2. Turn the key clockwise (90 degrees) to turn the scooter on.
3. On the tiller, gently operate the Control lever or Wig-Wag as described earlier, (7.1.2 for the wigwag and 7.2.2 for the side control lever). You will gently accelerate. Release and you will gently stop. Practice these two basic functions until you get used to them.
4. Steering the scooter is easy and logical. Just be sure to remember to get wide clearance when turning so that the rear wheels clear any obstacle.
5. Short-cutting a pavement corner can cause the back wheel to go off the pavement, causing problems, if the corner is very rough. Avoid this at all times by steering an exaggerated curve around the obstacle.
6. When steering in a tight spot, such as entering a doorway or when turning around, stop the scooter and then turn the handlebar to where you want to go, then apply power gently. This will make the Elite turn tightly. It is also recommended that the pre-set speed is set to a slower setting to aid control in tight spots.

### DANGER!

Reversing requires extra attention as the field of vision is restricted.

### Elite<sup>2</sup> RS, XS

Using the right thumb or left fingers to operate the Wig-Wag will reverse the scooter.

### Elite<sup>2</sup> PLUS

Pushing down on the control lever or pulling back on the upper knob will reverse the scooter.

Remember, the more you push the Wig-Wag, lever or side control lever the faster you will go.

Reverse speed is programmed to 50% slower than forward speed.

### DANGER!

It is advisable that during the first few **sessions** of operating your scooter that the area around you is clear of obstacles and pedestrians.

Before operating your Scooter, ensure the seat height has been adjusted to your satisfaction, and the tiller angle has been set for optimum safety and comfort.

### DANGER!

- When using your Scooter on public walk ways and footpaths, always be aware of pedestrians and situations which might require extra care.
- Be especially vigilant around young children and pets.
- Remember, when driving in public places drive with caution and regard for others at all times.
- When manoeuvring in confined areas, including shops, ensure the minimum speed is selected.
- If you leave your Scooter unattended, ensure that it does not obstruct pedestrians or other road users.
- Remember to keep the key with you at all times for your safety and security.
- For the safety of the operator and other pedestrians, Sunrise Medical recommends that whilst driving on footpaths and other pedestrian walk ways, the scooter preset speed should be set to less than 4 mph/6kph.

## 7.8 BRAKING

To stop the Scooter simply release the Wig-Wag or side control lever, whilst keeping your hands on the handlebar. Two types of braking will automatically operate in sequence:

- Automatic regenerative braking, which slows the Scooter to a standstill.
- Automatic parking brake which will operate as the scooter comes to a stop. The automatic parking break holds the Scooter in position, even if you are on a hill.

**NOTE:** This is a two stage process and is not instantaneous. First the scooter slows down and stops, then the parking brake comes on. When starting off again the parking brake will release automatically. If the throttle is momentarily engaged and released, the parking break will release and then engage again in approximately 1/2 a wheel turn.

### 7.9 EMERGENCY BRAKING USING THE HANDBRAKE

In the unlikely event of an unwanted movement of the Scooter, use the Parking Braking System (PBS) hand brake. The Parking Braking System (PBS) is operated by pulling the hand brake lever on the tiller, this will slow the scooter to a controlled stop.

Handlebar mount, (Fig.7.9.1), side lever mount, (Fig.7.9.2)

The hand brake automatically stops the drive unit by way of an electrical connection. Releasing the hand brake lever will allow the drive unit to function again.

**NOTE:** The scooter will not drive with the handbrake applied.

### 7.10 EMERGENCY BRAKING USING THE KEYSWITCH

In the unlikely event of an unwanted movement of the Scooter, turning the keyswitch OFF will cause the Scooter to come to an immediate stop. Though very effective, emergency braking is extremely abrupt and must never be used in normal use.

### 7.11 SWITCHING OFF

The Scooter must always be switched off at the On/Off key switch.

**NOTE:** The scooter can remain safely on charge for a couple of weeks. When the Scooter is not to be used for a long period of time, first charge the batteries fully and then disconnect them from the scooter. Store as close to room temperature as is possible.



Fig.7.9.1

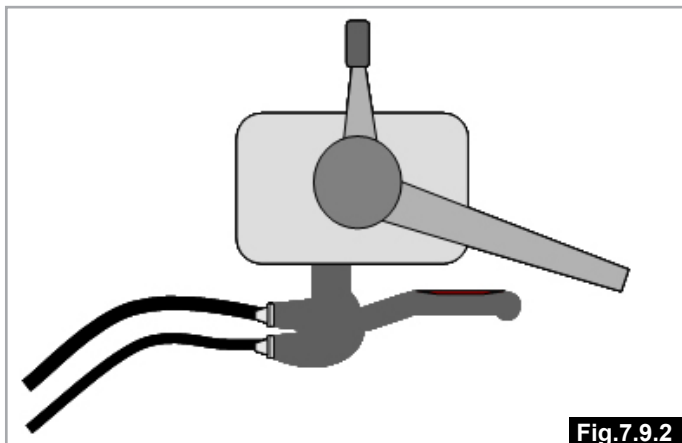

Fig.7.9.2

### 7.12 THROTTLE SELECT SWITCH

This switch is used to select between the foot control and any handlebar control.

**NOTE:** A latching, (push On-push Off), type switch is used for this function, (Fig.7.12.1).

#### **WARNING!**

- When the scooter is turned off, the control that was selected at the time of switching off will still be selected when the scooter is turned back on again.
- Use caution when first starting off after a break in driving.
- Keep any luggage/bags, clear of fouling the foot control at all times.



### 7.13 DIRECTIONAL SWITCH

This switch is used to select between the forward or reverse direction of travel, (Fig.7.13.1).

The directional switch is always used with any non-wigwag throttle, ie. foot control and twist grip throttle. When reverse is selected a warning flashing arrow appears on the LCD display of the Elite<sup>2</sup> XS -RS, (Fig.7.13.2), or scrolling arrows appear on the LCD display of the Elite<sup>2</sup> Plus, (Fig.7.13.3).

#### **WARNING!**

- When the scooter is turned off, the direction that was selected at the time of switching off will still be selected when the scooter is turned back on again.
- Use caution when first starting off after a break in driving.
- Use caution when reversing.
- Always stop the scooter before switching between forwards and reverse.
- Do not reverse downhill on an uneven surface.
- Do not reverse and turn on any uneven surface.
- Never reverse around a blind corner.
- Always give way to people on foot.

If your head/neck movement is restricted when reversing:

- Use your mirrors.
- Select the lowest usable speed setting.
- Do not make any sudden manoeuvres.
- Listen out for any audible clues, (children shouting, running etc).
- Be prepared to stop immediately.

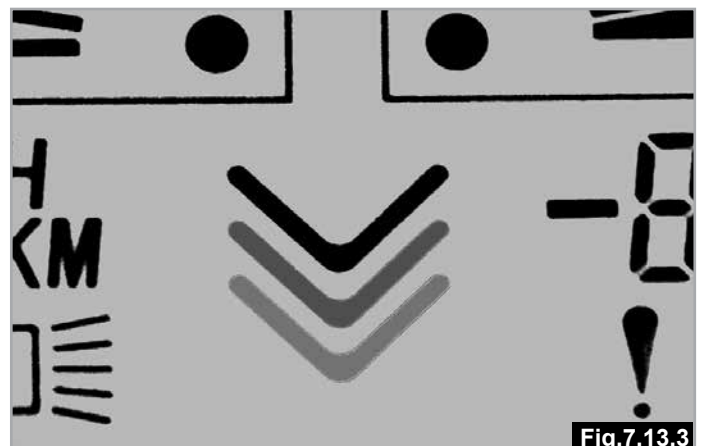
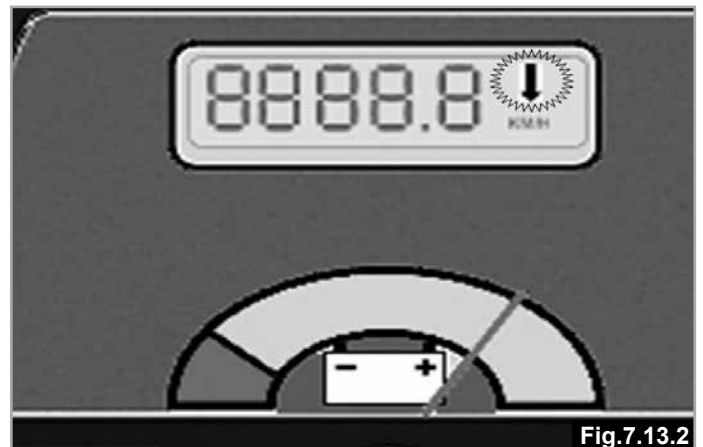

## 8.0 Troubleshooting Using the LCD

### 8.1 ELITE<sup>2</sup> PLUS DISPLAY

(Fig.8.1.0).

Always consult your Sunrise Medical authorised dealer when a diagnostic fault has appeared on your scooter display.

Elite<sup>2</sup> PLUS Fault- The battery gauge shows the status of the control system, and the fault graphic ! on the display.

#### Battery Gauge is steady

This indicates that everything is OK.

#### Battery Gauge flashes slowly

The control system is functioning correctly but the batteries need charging as soon as possible.

#### Battery Gauge steps up

The scooter batteries are being charged. You will not be able to drive the scooter until the charger is disconnected and you have switched the control system off and on again.

#### Battery Gauge flashes rapidly

The control system safety circuits have operated and the control system has been prevented from moving the scooter.

This indicates a system trip. i.e. the power module has detected a problem somewhere in the scooters electrical system.

Switch the scooter off.

Check that none of the plugs and sockets have become loose or disconnected.

Check the condition of the battery.

If you can't find the problem, try the self help guide on the next page.

Switch the scooter on again and try to drive the scooter.

If the safety circuits operate again, switch off and do not try to use the scooter.

Contact your Sunrise Medical authorised dealer.

### 8.2 ELITE<sup>2</sup> XS, RS DISPLAY

Always consult your Sunrise Medical authorised dealer when a diagnostic fault has appeared on your scooter display.

Elite<sup>2</sup> XS,RS Fault- The LCD displays the fault bar number, (Fig.8.2.0).

Incase of a brake fault (4 bar) the display will show, "brake" and the horn will sound, (Fig.8.2.1).

The displays above indicate the control system safety circuits have operated and the control system has been prevented from moving the scooter.

This indicates a system trip. i.e. the power module has detected a problem somewhere in the scooters electrical system.

Switch the scooter off.

Check that none of the plugs and sockets have become loose or disconnected.

Check the condition of the battery.

If you can't find the problem, try the self help guide on the next page.

Switch the scooter on again and try to drive the scooter.

If the safety circuits operate again, switch off and do not try to use the scooter.

Contact your Sunrise Medical authorised dealer.

**NOTE:** Taking the scooter from a warm indoor environment to very cold outside surroundings may cause the display to mist for a short time. This is harmless and will clear quickly.

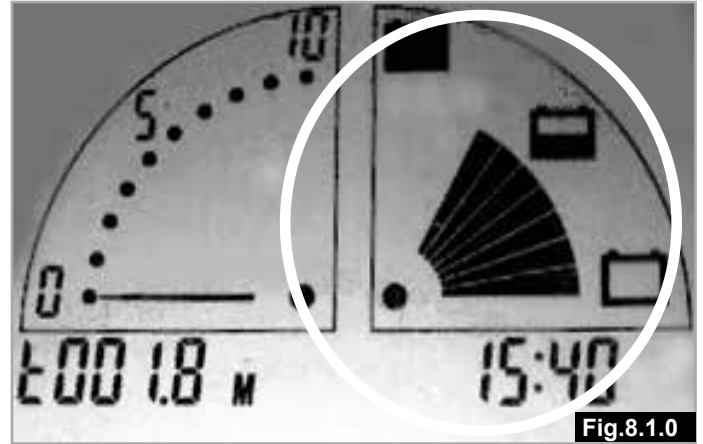

Fig.8.1.0

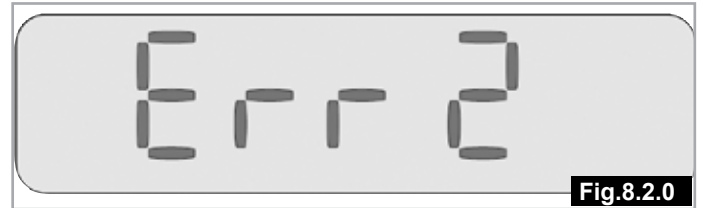

Fig.8.2.0

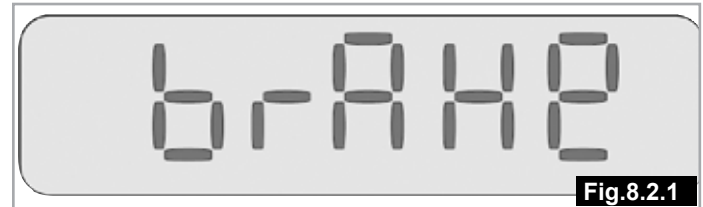

Fig.8.2.1



## FAULT CODES AND POSSIBLE CAUSES.











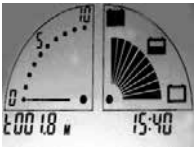

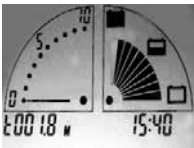
ELITE <sup>2</sup> PLUS	ELITE <sup>2</sup> XS - RS	
		<b>An excessive voltage has been applied to the Power Module.</b> Check the battery connections. Check the correct battery charger is being used and that it is functioning properly.
		<b>The parking brake has a bad connection.</b> Check all connections between Motor, Brake and Power Module.
		<b>A general control system fault has been detected.</b> Check that all plugs and sockets are connected. If the scooter has been driven in extreme weather, gone through a deep puddle or has been jet washed, place it in a dry warm environment to dry out.
		<b>A throttle fault has been detected.</b> Ensure that the throttle levers are at the neutral or rest position.
		<b>The scooter is being prevented from driving by the control system because of an inhibit signal..</b> Check that the charger plug is disconnected from the charge socket.
		<b>This is not used.</b>
		<b>The freewheel lever/switch is activated.</b> Switch the scooter off, put the scooter back into "DRIVE" mode and switch the scooter back on again.
		<b>The Motor has a short circuit to a battery connection.</b> Contact your servicing agent.
		<b>There is a bad connection to the Motor.</b> Check all connections to the Motor and Power Module. Check Motor brushes.
		<b>The battery needs charging or there is a bad connection to the battery.</b> Charge the batteries. Check the connections to the batteries are tight. Check the battery charger is switched on and working. Batteries need changing.

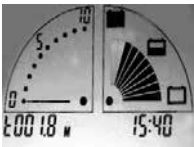
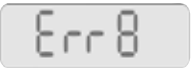
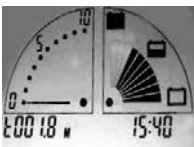
Fig.8.3.1

### 8.3 SELF HELP GUIDE

If a system trip occurs you can find out what has happened by checking the scooter display, (Fig.8.3.1).

Elite<sup>2</sup> PLUS - counting the number of bars on the battery gauge that are flashing.

Go to the number on the list which matches the number of flashing bars and follow the instructions.

Elite<sup>2</sup> XS, RS – check the error code displayed on the LCD screen.

Go to the number on the list which matches code and follow the instructions.

Slow or sluggish movement - If the scooter does not travel at full speed or does not respond quickly enough and the battery condition is good, check the maximum speed setting. If adjusting the speed setting does not remedy the problem then there may be a non hazardous fault. Consult your Sunrise Medical authorised dealer.

## 9.0 Batteries and Charging

### WARNING!

 Please read the owner's manual supplied with the charger carefully. The general procedures and effects for the interference with the scooter and the batteries remain valid.

- Do not smoke near batteries.
- Do not expose any part of the battery to direct heat (i.e. naked flame, gas fire).
- When charging always place your charger on a hard surface in a room with good ventilation.
- You should not charge your batteries in outdoor conditions using the supplied charger.
- For outdoor charging please use a battery charger specifically designed for outdoor charging of 24v deep cycle mobility batteries, that has an IP rating of IPX5 or higher.

### 9.1. BATTERY & CHARGER SPECIFICATION:

#### Batteries:

24 V (2x12 V) / 60 Ah., Gel Type-maintenance-free

Dimensions:

Please see Technical Specifications.

**NOTE:** Optional batteries with different capacities are available.

Dimensions:

Please see Technical Specifications.

#### Charger:

Connector: 3 pin "Nuetric" type

Charger: 24V d.c. 8 A Cyclic.

**NOTE:** Other cyclic chargers designed for GEL batteries may be used, up to a maximum power output of 10A.

### WARNING!

It is the responsibility of the person electing to use an alternative battery charger to ensure that the chosen battery charger is fully compatible with the scooter.

### 9.2 ELECTRICAL FUSES:

To prevent the scooter from becoming overloaded, fuses have been built into the battery looms. The fuses automatically isolate the battery from the scooter wiring and control systems in the event of an electrical short circuit.

If you suspect that the fuses have blown, contact your Sunrise Medical authorised dealer as soon as possible, who will carry out a full diagnostic to determine the cause of the original fault.

### WARNING!

- Do not attempt to change the fuses yourself.
- Do not attempt to by-pass the fuse as this would be very dangerous. If you suspect a fault, contact your Sunrise Medical authorised dealer as soon as possible.

### 9.3 BATTERIES

For all warnings and the detailed removal process please refer to section "5.3 Batteries", on pages 18 and 19.

### 9.4 GENERAL BATTERY INFORMATION

Batteries are the power source for almost all of the modern mobility products available today. The design of batteries used in mobility products is significantly different to the batteries used to start a car for example.

Car batteries are designed to release a large amount of power over a short period of time, whilst mobility batteries (commonly called deep cycle batteries) release their power evenly, over a long period of time. Therefore, due to the lower production volumes and increased technological requirements, mobility batteries are typically more expensive.

Commonly two 12 volt batteries are used together in a mobility product, giving a total voltage of 24 volts. The size of the battery (e.g. its available power) is expressed in amps per hour e.g. 70 A/hr. The higher the number, the bigger the battery size, weight and, potentially, the greater the distance you can travel. Sunrise Medical only fit as standard maintenance-free mobility batteries into these types of scooters.

### 9.5 MAINTENANCE-FREE BATTERIES:

This type of battery uses a method of carrying the electrolyte commonly referred to as 'gel', that is held within the battery case. As the name implies, no maintenance is required other than regular charging. You can safely transport this type of battery without fear of acid spilling. Furthermore, they are approved for transportation on aircraft, trains and ships.

### 9.6 BATTERY CARE:

Over the years, battery technology has moved forward but, unfortunately, some of the advice given on battery care has not. This has resulted in a number of confused and at times contradictory instructions on the 'best' way to care for your batteries. This section will help to dispel some of these myths and legends. Below is set out a battery care plan for maintenance-free batteries. This has been agreed between Sunrise Medical and the battery manufacturers, to enable you to get the best out of your batteries. If a different care plan is followed, this may result in lower than expected performance from your mobility vehicle.

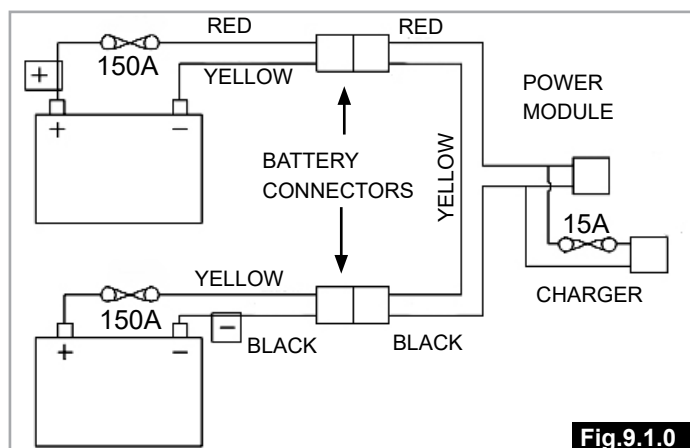

Fig.9.1.0

### 9.7 MAINTENANCE-FREE BATTERY CARE PLAN:

Only use an approved Sunrise Medical charger compatible with the vehicle to be charged.

- Charge your batteries every night, regardless of the amount of use your mobility device has had during the day.
- Do not interrupt the charging cycle.
- If your mobility device is not required for use, it should remain connected to the charger until required. This will not damage your batteries, as long as the mains socket/plug is left switched on. Turning the mains socket/plug off, but leaving the mains cable plugged in will eventually deplete your battery charge.
- If you leave your vehicle for an extended period (more than 1 week), charge the batteries fully and then disconnect the main battery lead. When the scooter is to be used again, charge the batteries for a further 24 hours before use.
- Failure to allow for recharge will damage the batteries and can lead to shortened distances and premature failure.
- Do not top up the charge of your batteries during the day. Wait until the evening for a full overnight charge.
- As a general rule, maintenance-free batteries take longer to fully charge than wet lead acid batteries.
- The battery terminals need to be checked regularly for signs of corrosion. If any corrosion is apparent, then clean the terminals completely (a wire brush is ideal) and re-grease the terminal using Vaseline petroleum jelly, not ordinary grease. Ensure that the terminal nut and bolt, cable clip and exposed cable are completely covered with jelly.
- Following all the points above should result in a healthier battery, greater range for the vehicle user and a longer life for your batteries.
- Return the batteries back to Sunrise Medical or directly to the battery manufacturer for recycling, when they no longer hold charge.

For instructions on Medium to Long term Storage see section 12.3

### 9.8 GENERAL CHARGER INFORMATION:

The external charger has been designed to charge two 12 V Gel type batteries connected in series (= 24 V).

### 9.9 CHARGER SPECIFICATION:

#### **WARNING!**

Only use cyclic chargers designed for mobility batteries, Gel-Type, with a maximum output not exceeding 24V/10A.



For more information about the charger operation, consult the instructions provided with the charger.

**NOTE:** If the charger is not connected to the scooter, it does not output charge voltage.

#### **WARNING!**

It is possible that the charger's metallic box may slightly raise in temperature due to use.

### 9.10 CHARGER SAFETY FEATURES:

The charger has features that prevent hazards or accidents occurring as a result of connecting batteries the wrong way round, overheating caused by fault conditions or attempting to charge wrong voltage batteries.

The majority of chargers are electrically double insulated and no earth connection is required. Some larger sizes may be electrically earthed and this will be clearly stated on the label.

The 3 pin UK mains input plug contains a replaceable fuse. The rating of this fuse is shown on the charger label.

#### **WARNING!**

- Always replace fuses with the same type and size of fuse as specified.
- Fitting of different fuses can result in damage to the charger or failure of the charger to operate properly.
- If your charger has been specified for use in Continental Europe it will contain a European two pin plug which does not have a fuse. In this case the fuse is located inside the case or on the fascia panel of the charger.

### 9.11 PROCEDURE FOR CONNECTING THE CHARGER AND CHARGING:

The scooter can be charged via the charger socket on the rear of the tiller panel. Fig 9.11.1

- Ensure the scooter is switched off.
- First, connect the charger to the scooter.
- Then, connect the charger to the mains supply by means of the mains plug and switch on.
- The GREEN LED will illuminate to show that the power is ON, (Fig.9.11.2).
- The YELLOW LED will illuminate to show the batteries are charging, (Fig.9.11.2).
- The YELLOW LED will switch off when the charge cycle is complete, (Fig.9.11.2).

#### **CAUTION!**

- Do not leave the charger connected to the battery with the mains disconnected or switched off. This could result in damage to your battery being caused by deep discharge over a period of time.
- Always switch off at the mains before disconnecting the charger from the scooter.

#### **WARNING!**

 If an alternative charger has been chosen, please read the user instruction manual supplied with that charger as they may differ from the instructions show above.

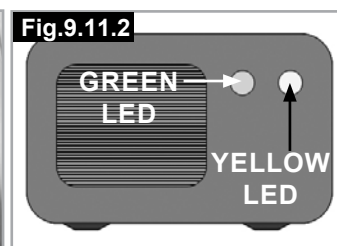

## 9.12 CHARGER SAFETY AND CAUTION NOTES:

### WARNING!

- The supplied charger is designed for indoor use. Do not use outdoors or expose to rain, snow, spray or moisture.
- For outdoor charging please use a battery charger specifically designed for outdoor charging of 24v deep cycle mobility batteries, that has an IP rating of IPX5 or higher.
- When buying replacement batteries or charger always consult your Sunrise Medical service agent.
- The charger may be used with other brands of Gel type batteries, subject to written confirmation from the Technical Department of Sunrise Medical.
- To reduce the risk of damage to electric plug and cord, pull by the plug rather than the cord when disconnecting the charger.
- Make sure the cord is located so that it will not be stepped on, tripped over or otherwise subjected to damage or stress or cause a trip hazard.
- A mains extension cord should not be used unless absolutely necessary.
- Use of an improper extension cord could result in a risk of fire and electric shock.
- If any extension cord must be used, make sure the pins on the plug of the extension cord are the same number, size and shape as those of the plug on the charger and that the extension cord is properly wired and in good electrical condition.

## 9.13 THE RANGE OF YOUR VEHICLE:

The batteries give the scooter a range of approximately 44 kilometres.

Most manufacturers of mobility products state the range of their vehicles either in the sales literature or within the Owner's Manual. The range stated sometimes differs from manufacturer to manufacturer even though the battery size is the same. Sunrise Medical measure the range of their vehicles in a consistent and uniform manner, but variances still occur due to motor efficiencies and overall product load weight.

The range figures are calculated to I.S.O. Standard 7176. Part 4: Wheelchair Energy Consumption Theoretical Range.

This test is carried out in controlled conditions with new, fully charged batteries, on a level test surface and a user weight of 100 kg. The range figures stated should be seen as a theoretical maximum and will be reduced if any single, or combination, of the following circumstances occur:

- User weight heavier than 100 kg.
- Batteries whose age and condition are less than perfect.
- The terrain is difficult e.g. very hilly, sloping, muddy ground, gravel, grass, snow and ice.
- The vehicle climbs kerbs regularly.
- The ambient temperature is very hot or very cold.
- Incorrect tyre pressures in one or more tyres.
- Lots of start/stop driving.
- Also thick pile carpets within the home can affect range.
- Use of additional power consumption options (e.g. lights, actuators, etc.).

The battery sizes available on each Sunrise Medical product should give sufficient range to cope with the majority of customer's requirements. However, everyone is different. There are different sizes of batteries available as spares. Don't forget the scooter can also be programmed to suit your specific needs. Please contact your approved Sunrise Medical dealership for further information.

## 10.0 Adjustments

### WARNING!

- Only undertake adjustments on your scooter if you are qualified to do so.
- Serious injury or damage can occur if adjustments are not carried out correctly.
- If you are unsure please contact your Sunrise Medical dealer for assistance.

### 10.1 SEAT HEIGHT ADJUSTMENT

- Remove the battery cover to access the seat height adjustment bolts.
- Remove the two seat stem fixing bolts (Fig 10.1)
- The seat height can be adjusted to a range of 75mm.
- Replace the two bolts in the upper and lowest hole of the seat stem



Fig.10.1

### 10.2 ELITE<sup>2</sup> PLUS TILLER HEIGHT ADJUSTMENT

The Elite<sup>2</sup> PLUS tiller has a standard height adjustment of 0mm – 50mm

Access to the height adjustment bolt is via the hole in the rear of the tiller panel. (Fig 10.2 overleaf).

- Place a 6.0mm allen key through the hole and into the head of the bolt.
- Once the bolt is loosened, the tiller height can be adjusted.
- Carefully pull the tiller up using the tiller steering handle.
- Once at the preferred height, tighten the bolt to fix the steering column.



Fig.10.2

### 10.3 PROGRAMMING:

When the scooter leaves the factory, it is programmed to best suit the general needs of our customers. This is a generic or default programme. However, if any alterations are required, then you should contact your dealer, where a specialist can reprogramme the scooter to fine tune it to your needs.

**NOTE:** A programmer or a PC-based software program with the appropriate connecting lead are required to program the wheelchair, (Fig.10.3).

#### WARNING!

- Never attempt to programme the scooter yourself.
- Programming the controller of the scooter is only allowed through authorised personnel trained by Sunrise Medical.
- Incorrect controller settings could cause a driving profile outside the safe limits and could result in damage or injury.



Fig.10.3

## 11.0 Cleaning

### 11.1 CLEANING GENERAL:

#### WARNING!

Ensure the controller is switched off before cleaning.

- The scooter should be wiped over once per week with a slightly damp, (not wet), cloth and any fluff or dust that has accumulated around the motors should be blown or dusted away.
- Make sure that you dry all parts of your scooter if it becomes wet or damp after cleaning or if it is used in a wet or damp atmosphere.
- It is important that should the scooter be used by more than one person it is cleaned thoroughly to ensure there is no cross infection.
- You should use a proprietary disinfectant for this task. Please pay attention to the manufacturer's instructions of the disinfectant you are using.
- Inspect the upholstery/seating for tears, dents, wearing or slackening of upholstery particularly near to metal as this could result in poor posture or lower levels of comfort and pressure relief.

### 11.2 CLEANING SEATING:

All parts/accessories such as crutch holders should be cleaned with a damp cloth.

All lateral supports, headrest, armrests, lap belts should be cleaned with a damp cloth.

#### CAUTION!

Do not use a hose or a pressure or steam washer to clean your scooter.

### 11.3 CLEANING CONTROL SYSTEM:

Clean the control system and the keypad with a cloth dampened with diluted detergent. Be careful not to use excessive water or force when cleaning the control keypad.

#### CAUTION

Never use abrasive or spirit based inflammable cleaners.

## 12.0 Shipping and Storage

### 12.1 STORAGE TEMPERATURE & HUMIDITY:

Storage Temperature: Min: -25°C, (-40°C without batteries) Max: 50°C

Relative Humidity (non-condensing): Min: 5% Max: 95%.

Storing and charging should be done under a roof. The charger must be placed dry and should not be covered when in use. For longer storage cover the product to protect against dust, rain and direct sunlight.

Please note that the product can be equipped with different kinds of chargers, when used in 0°C the capacity of the battery is reduced by approximately 25%. Always read the User Manual for your charger. If you have the Power Charge Classic 8A charger this can be used for charging in 10°C in a dry environment, i.e. dry and protected from rain, snow etc. If you need to charge in colder environment you should use a charger which is temperature controlled.

### 12.2 SPECIAL SHIPPING REQUIREMENTS:

The scooter may be transported by road, rail, sea or air and the batteries conform to IATA regulations.

#### CAUTION!

Before you travel, please contact the appropriate carrier. The travel operator will be able to supply details of any special requirements/instructions.

- Ensure that any detachable parts are secured with your scooter or separately packed and labelled so they do not get lost during loading and unloading.
- Take this Owner's Manual with you.
- The carrier will need to refer to the following sections.
- How to remove the seat, (Section 5.1, Page 17).
- How to disconnect the batteries, (Section 5.3, Page 18).
- How to disconnect the drive, (Section 4.7, Page 9).

### 12.3 MEDIUM TO LONG TERM STORAGE:

When storing your scooter for long periods of time (in excess of one week), follow these simple instructions: Fully charge the scooter for at least 24 hours, then disconnect the batteries and store them separately at room temperature.

#### CAUTION!

Avoid storing your scooter for medium to long periods of time:

- Outside.
- In direct sunlight, (plastic parts may discolour).
- Near a source of direct heat.
- In a damp environment.
- In a cold environment, (Min: 10°C with batteries on board).
- With the batteries connected, (even if the controller is switched off).

Avoiding all of the above will minimise battery deep cycle discharge and extend battery lifetime.

When returning the scooter to use, please reconnect the batteries/battery boxes and charge the scooter for at least 24 hours before using again.

### 12.4 WEIGHT OF DETACHABLE PARTS

PART	WEIGHT kg
SEAT	22.8
FRONT BASKET	0.9
TOP BOX	1.9
LEG REST	1.9
AMPUTEE PAD	0.8
BATTERY BOX LID	1.1
RAISED FOOT PLATFORM	3.2
SEAT BACK EXTENSION	1.0
HEAD REST	0.7

## 12.5 USING YOUR SCOOTER ON THE TRAIN:

If you wish to use your scooter on the train, we recommend that you contact the train operator in advance when planning your journey. Railway carriages have provision for a "wheelchair" space where you can sit on your scooter during the journey. Please note that the overall length of your scooter may be greater than the available length of the "wheelchair" space in the railway carriage.

When planning your journey, you should check with the train operator that there will be suitable boarding access available to allow you to access the railway carriage and the intended "wheelchair" space on joining and leaving the train and there is suitable access onto the platform. We recommend you check with the train operator that ; the boarding access is suitable for the combined mass of your scooter and the occupant; the slope of the access is not greater than the maximum safe slope of the scooter; any steps or risers are no greater than the maximum height of the scooter obstacle climbing height; there is adequate turning space within the access area to the train and on the train.

Most train operators will provide assistance provided that arrangements have been made in advance. We suggest you have you Owner's Manual ready when planning your journey and contacted them.

## 12.6 OTHER TRANSPORT REQUIREMENTS:

The scooter may be transported by road, rail, sea or air as luggage.

Before you travel, please contact the appropriate carrier or travel operator. You may be asked to provide certain information about the scooter such as the scooter mass and overall dimensions. This information can be found in the relevant model tables in section 15.1.

If the scooter is transported by air, the batteries may need to be removed as the batteries supplied are not IATA approved for air travel. Your dealer can assist in supplying batteries that are IATA approved.

If transporting the scooter by road as luggage, it may need to be secured to prevent unintended movement into other vehicle passengers in the event of a sudden stop or placed in a space reserved for luggage. Your scooter can be secured by attaching suitable restraints to the front and rear bumpers as shown on the figure below.

### **WARNING!**

Do not sit in your scooter when it is transported as luggage.



## 13.0 Disposal

The symbols below, mean that in accordance with local laws and regulations your product should be disposed of separately from household waste.

When this product reaches the end of its life, take it to the local collection point designated by local authorities. The separate collection and recycling of your product at the time of disposal will help conserve natural resources and ensure that it is recycled in a manner that protects the environment.

**NOTE:** Ensure you are the legal owner of the product prior to arranging for the product disposal in accordance with the above.

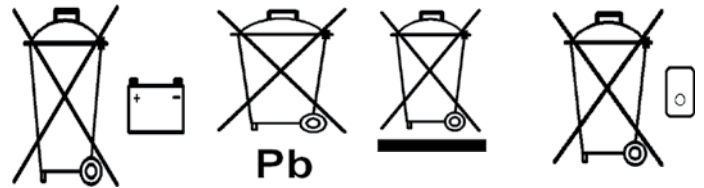



## 14.0 Torque Settings

### **WARNING!**

- Do not attempt to dismantle and/or reassemble the scooter on an engineering level, or fit any replacement parts or accessories if you are not qualified/authorised to do so.
- Always consult your approved Sunrise Medical servicing agent.

The torque information supplied below will enable normal routine maintenance tasks to be performed, (please also see section 18).

<b>GENERAL TORQUE SETTINGS</b>	
<b>DESCRIPTION</b>	<b>TORQUE VALUE</b>
M3 POZI PAN	2-3 Nm
M4 POZI PAN	3-4 Nm
M5 SKT HD CAP	4-5 Nm
M5 POZI PAN	4-5 Nm
M6 HEX HD	9-10 Nm
M6 BUTT HD	9-10 Nm
M6 SKT HD CAP	9-10 Nm
M8 HEX HD	15-20 Nm
M8 SKT HD CAP	15-20 Nm
M8 SKT BUTT HD	15-20 Nm
M10 HEX HD	20-25 Nm
M10 SKT BTT HD	20-25 Nm
<b>SPECIFIC TORQUE SETTINGS</b>	
Front Wheel Axle Bolt	32-Nm
Rear Wheel Hub Studs	25Nm
Seat Stem Height Bolts	20 Nm

## 15.0 Specification Sheets (EN 12184 & ISO 7176-15)

Sunrise Medical Logistics BV  
 Groningenhaven 18-20, 3433  
 PE, Nieuwegein, Netherlands  
 T: +31 (0)30 - 60 82 182 Customer Service  
 F: +31 (0)30 - 60 55 880  
 www.sunrisemedical.com

Operating temp: -25degC to 50DegC  
 Storage temp: -40degC to 65degC  
 Moisture resistance: IPX4  
 No restrictions on humidity and air pressure

### MODEL: STERLING ELITE2 XS, RS



#### Maximum occupant mass: 175 kg

The Sterling Elite2 XS, RS conforms to the following standards:

- requirements and test methods for static, impact and fatigue strengths (ISO 7176-8)
- power and control systems for electric wheelchairs requirements and test methods (ISO 7176-14)
- climatic test in accordance with ISO 7176-9
- requirements for resistance to ignition in accordance with ISO 7176-16
- the product is specified as a Class C power product
- all materials used on this product conform to EN1021 parts 1 and 2

**NOTE:** Measurements of upholstered parts are approximate. All other measurements may be subject to change

ISO 7176-15	MIN.	MAX.	COMMENTS
Overall length	1390mm	1390mm	standard configuration
Overall width	670mm	670mm	standard configuration
Total mass (with batteries)	132kg	132kg	standard configuration
Mass of the heaviest part	-	23kg	72 Ah Battery
Static stability downhill	-	15°	175kg User
Static stability uphill	-	15°	175kg User
Static stability sideways	-	15°	175kg User
Energy consumption (max. range)	-	44km	To ISO 7176-15
Dynamic stability uphill	-	10°-18%	175kg User
Obstacle climbing	-	100mm	standard configuration
Ramp transition	8°	8°	without high centring
Max. speed forward		15kph	standard configuration
Min. brake distance from max. speed	-	4.5m	with standard programming
Max. speed reverse	-	50%	% of forwards speed
Effective seat depth		460mm	standard configuration
Effective seat width		475mm	standard configuration
Seat surface height	440mm	515mm	to scooter floor
Back rest angle	-45°	+45°	from vertical
Back rest height		510mm	standard configuration
Fore / aft seat adjustment	-80mm	+80mm	from centre position
Seat weight with slide		22kg	standard configuration
Top of arm rest to seat		80mm	arm rest set at 90°
Min. turning radius		1400mm	standard configuration
Min. turn between walls		1850mm	standard configuration
Nominal battery voltage	24V	24V	two 12V batteries
Reversing width	1600mm	-----	
Controller cut-off voltage	16V		drive stops
Battery capacity	60Ah	72Ah	see options
Battery fusible links	-	150A	In-line fuse on each battery
Battery charger loom fusible link	-	15A	
Battery charger	8A	10A	automatic cyclic
Max. kerb height		100mm	
Ground clearance		110mm	
Rear suspension travel		50mm	Unladen
Front suspension travel		25mm	Unladen
Rear wheel drive	-	-	3 wheel scooter
Scooter push force		100N	in freewheel
Crash tested		-	-
Tyre Pressure			1.8-2.0 bar, (25-28 P.S.I.)

**MODEL: STERLING ELITE2 PLUS**



**Maximum occupant mass: 175 kg**

The Sterling Elite2 PLUS conforms to the following standards:

- a) requirements and test methods for static, impact and fatigue strengths (ISO 7176-8)
- b) power and control systems for electric wheelchairs requirements and test methods (ISO 7176-14)
- c) climatic test in accordance with ISO 7176-9
- d) requirements for resistance to ignition in accordance with ISO 7176-16
- e) the product is specified as a Class C power product
- f) all materials used on this product conform to EN1021 parts 1 and 2.

**NOTE:** Measurements of upholstered parts are approximate. All other measurements may be subject to change

ISO 7176-15	MIN.	MAX.	COMMENTS
Overall length	1390mm	1390mm	standard configuration
Overall width	650mm	650mm	standard configuration
Total mass (with batteries)	140kg	140kg	standard configuration
Mass of the heaviest part	-	23kg	72 Ah Battery
Static stability downhill	-	15°	175kg User
Static stability uphill	-	15°	175kg User
Static stability sideways	-	15°	175kg User
Energy consumption (max. range)	-	44km	To ISO 7176-15
Dynamic stability uphill	-	10° -18%	175kg User
Obstacle climbing	-	100mm	standard configuration
Ramp transition	8°	8°	without high centring
Max. speed forward		15kph	standard configuration
Min. brake distance from max. speed	-	4.5m	with standard programming
Max. speed reverse	-	50%	% of forwards speed
Effective seat depth		460mm	standard configuration
Effective seat width		475mm	standard configuration
Seat surface height	440mm	515mm	to scooter floor
Back rest angle	-45°	+45°	from vertical
Back rest height		510mm	standard configuration
Fore / aft seat adjustment	-80mm	+80mm	from centre position
Seat weight with slide		22kg	standard configuration
Top of arm rest to seat		80mm	arm rest set at 90°
Min. turning radius		1400mm	standard configuration
Min. turn between walls		1850mm	standard configuration
Reversing width	1600mm	-----	
Nominal battery voltage	24V	24V	two 12V batteries
Controller cut-off voltage	16V		drive stops
Battery capacity	60Ah	72Ah	see options
Battery fusible links	-	150A	In-line fuse on each battery
Battery charger loom fusible link	-	15A	
Battery charger	8A	10A	automatic cyclic
Max. kerb height		100mm	
Ground clearance		135mm	
Rear suspension travel		85mm	Unladen
Front suspension travel		50mm	Unladen
Rear wheel drive	-	-	3 wheel scooter
Scooter push force		100N	in freewheel
Crash tested		-	-
Tyre Pressure	2.4-2.5 bar (33-35 P.S.I.)		

## 16.0 Guarantee

### THIS GUARANTEE DOES NOT AFFECT YOUR LEGAL RIGHTS IN ANY WAY.

Sunrise Medical\* provides a guarantee, as set out in the warranty conditions, for products to its customers covering the following.

#### Warranty conditions:

1. Should a part or parts of the product require repair or replacement as a result of a manufacturing and/or material fault within 24 months, then the affected part or parts will be repaired or replaced free of charge. The warranty will only cover manufacturing defects
2. To enforce the warranty, please contact Sunrise Medical Customer Service with the exact details of the nature of the difficulty. Should you be using the product outside the area covered by the Sunrise Medical customer service agent, repairs or replacement will be carried out by another agency as designated by the manufacturer. The product must be repaired by a Sunrise Medical designated Customer Service agent, (dealer).
3. For parts, which have been repaired or exchanged within the scope of this warranty, we provide a warranty in accordance with these warranty conditions for the remaining warranty period for the product in accordance with point 1).
4. For original spare parts which have been fitted at the customer's expense, these will have a 12 months guarantee, (following the fitting), in accordance with these warranty conditions.
5. Claims from this warranty shall not arise, if a repair or replacement of a product or a part is required for the following reasons:
  - a. Normal wear and tear, which include but is not limited to the following parts where fitted; batteries, armrest pads, upholstery, tyres, brakes shoes, ferrules, etc.
  - b. Any overloading of the product, please check the EC label for maximum user weight.
  - c. The product or part has not been maintained or serviced in accordance with the manufacturer's recommendations as shown in the user instructions and/or the service instructions.
  - d. Accessories have been used which are not specified as original accessories.
  - e. The product or part having been damaged by neglect, accident or improper use.
  - f. Changes/modifications have been made to the product or parts, which deviate from the manufacturer's specifications.
  - g. Repairs have been carried out, before our Customer Service has been informed of the circumstances.
6. This guarantee is subject to the law of the country in which the product was purchased from Sunrise Medical"

\* Means the Sunrise Medical facility from which the product was purchased.

DEALER STAMP

## 17.0 Service Advice/History

This section is designed to assist you in keeping a record of any service and repairs to your scooter. The service Agent will complete this section and return the manual to you.

**NOTE:** Please contact your local Sunrise medical approved servicing agent for any warranty, service or repair work required.

Model				
Serial Number				
Year	1	2	3	4
Service dates				
Controller				
On/Off switch				
Output plug				
Operation				
Dynamic braking				
Programmable configuration				
Batteries				
Physical Damage				
Connections				
Discharge tests				
Wheels/Tyres				
Wear				
Pressure				
Bearings				
Whel nuts				
Motors				
Wiring				
Noises				
Connections				
Brakes				
Brushes				
Freewheel Device				
Chassis				
Condition				
Steering				
Upholstery				
Seat				
Back				
Armrests				
Electric's				
Condition of loom				
Connections				
Lights & Indicators				
Test run				
Forward				
Reverse				
Emergency stop				
Left run				
Right run				
Up/Down slope				
Over obstacle				
Parking brake				

## 18.0 Service and Maintenance

After performing any maintenance or repairs on the scooter you must make sure that it is functioning correctly before it is used.

- Visually inspect the scooter to make sure its parts are correctly positioned and attached to the scooter and all fasteners are sufficiently tightened.
- Make sure that the seat is correctly fitted and adjusted.
- Switch on the scooter – Does the battery gauge flash with the ! symbol or error show on the LCD? This signifies that there is a fault in the electronic system.
- Refer to section 8.0 for basic troubleshooting.
- Perform the parking brake check.
- Operate all of the electric options, including lights and indicators to make sure that they work correctly.
- Drive the scooter to make sure the scooter performs as it did before.

### WARNING!

- If you are in any doubt about the performance requirements of your scooter contact your Sunrise Medical authorised dealer.
- Only carry out the maintenance tasks listed below together with any general cleaning.
- Do not attempt any task you are not sure of.

## 18.1 RE-USE

Due to its construction, high level of flexibility and the modular construction system make the Elite2 ideal for re-use. Individual accessories and options can be fitted and removed very quickly and are a range of possibilities so that individual adjustments can be made to suit the end user.

Maintenance and Inspection Schedule	Daily	Weekly	Quarterly	Six month	Annually
Check battery level indicator and charge if necessary.	*				
Check the control levers on the tiller are not bent or damaged.	*				
Ensure all removable parts are securely fastened.	*				
Check lap strap for wear and make sure the buckle is operational.	*				
Check the Parking brake clicks on and off.		*			
Check tyres and inflate if required.		*			
Ensure any visible nuts and bolts are tight.		*			
Ensure all cables and connectors are sound and are tidy and out of the way.		*			
Clean the scooter and upholstery regularly.		*			
Battery terminal inspection – Remove any corrosion and apply Vaseline.			*		
Check upholstery, seating, headrests, arm pads for wear.				*	
Complete inspection, safety check and service should be made by a Sunrise Medical authorised dealer.					*

## 18.2 WHEEL REMOVAL

### WARNING!

- It is not usually practical to try to repair a puncture in situ at the site of the occurrence. Sunrise Medical suggest that you call for help to remove the scooter either directly to an approved service agent, or to a safe place for collection by the approved agent at a later time.
- If you are in any doubt about the servicing requirements of your scooter contact your Sunrise Medical authorised dealer.
- Do not attempt any task you are not sure of.
- Do not attempt a puncture repair if the scooter has stopped in an unsafe area. Move the scooter to a safe area away from traffic and other hazards.
- Do not attempt a puncture repair in busy pedestrian areas.
- Do not attempt a puncture repair if the scooter is causing an obstruction.
- If you are using a jack or other equipment, always follow the user instructions given in the related Owners' Manual or User Instructions.
- Be aware that the scooter may fall off the jack at any time.
- Keep hands and feet clear of the scooter when it is on the jack.
- Do not stand the jack on uneven surfaces.
- Always use a support block or stand in conjunction with the jack.
- The scooter must be in drive mode with the power switched OFF and the keys removed, before jacking any wheel off the ground.
- Do not raise more than one wheel of the ground at any one time.

**NOTE:** Reverse the following procedures to refit the wheels unless otherwise stated.

### 18.2.1 ELITE<sup>2</sup> XS RS 3-Wheel Front Wheel Removal

- Elevate the front wheel by placing a jack under the relevant jack points, (Fig.18.1).
- When elevated back up the jack with solid blocks to increase stability, (Fig18.11).
- Use a 4.0mm Allen Key to remove the brake anchor stud, (Fig.18.2).
- Remove the brake cable from the outer sleeve by turning the knurled wheel until the slots align, (Fig.18.3).
- Lift the brake nipple out of the brake actuator arm, (Fig.18.4).
- Use a 19.0mm Socket and 10.0mm Allen key to undo the nut, (Fig.18.5).
- Start to withdraw the axle stud slowly, (Fig.18.6).
- First the washers will drop out, (Fig.18.7).
- Next lift the Brake assembly away from the hub, (Fig.18.8).
- The spacer falls away, (Fig.18.9).
- Remove the front wheel assembly, (Fig.18.10).

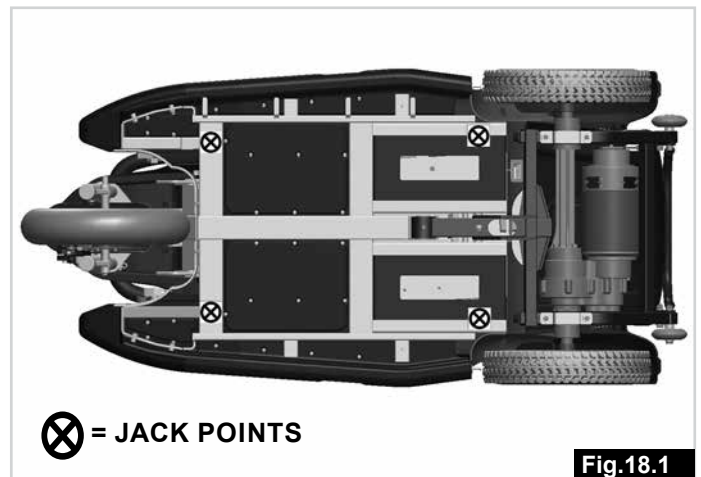

### 18.2.2 Elite<sup>2</sup> Plus 3-Wheel Front Wheel Removal

- Elevate the front wheel by placing a jack under the relevant jack points, (Fig.18.1).
- When elevated back up the jack with solid blocks to increase stability, (Fig.18.11).
- Use a 5.0mm Allen Key to remove the two disc brake anchor studs, (Fig.18.12).
- Gently lift the the disk brake calliper off, (Fig.18.13).
- Use a 10.0mm Allen key, (Fig.18.14), and a 19.0mm socket, (Fig.18.15), to remove the axle nut.
- Slowly pull the axle stud back through the front forks, **NOTE:** you may have to gently tap the axle stud to free it.
- Remove the large spacer, (Fig.18.16).
- Remove the small spacer, (Fig.18.17).
- Withdraw the axle stud, (Fig.18.18).
- Gently lift the front wheel out, (Fig.18.19).

### 18.2.3 Elite<sup>2</sup> XS RS Rear Wheel Removal

- Use a flat bladed screw driver to carefully lever off the hub cover, (Fig.18.20).
- With the wheel still on the ground: use a 19.0mm socket to loosen the hub nut, but do not release the nut more than two turns, (Fig.18.21).
- Elevate the rear wheel by placing a jack under the relevant jack points, then secure with blocks,(Fig.18.22).
- Use the socket wrench to finish releasing the nut.
- Remove the nut and washer, (fig.18.23).
- Carefully remove the wheel, (Fig.18.24).
- Remove the drive key from the drive shaft and keep it in a safe place, (Fig.18.25).



### 18.2.3 Elite<sup>2</sup> Plus Rear Wheel Removal

- Use a flat bladed screw driver to carefully lever off the hub cover, (Fig.18.26).
- With the wheel still on the ground: use a 6.0mm Allen key to loosen the 4 rim studs, but do not release the studs more than two turns, (Fig.18.27).
- Elevate the rear wheel by placing a jack under the relevant jack points, then secure with blocks,(Fig.18.28).
- Use the Allen key to finish releasing the studs.
- Remove the studs and washers, (Fig.18.29).
- Carefully remove the wheel, (Fig.18.30).
- Do not remove the drive hub from the drive shaft, (Fig.18.31).



### 18.3 CHANGING THE INNER TUBE (ALL)

- Ensure any remaining air is expelled by pressing the valve with a small screwdriver and squeezing the tyre, (Fig.18.32 - 18.33).
- Use a 6.0mm Allen key to undo the FIVE rim studs, (Fig.18.34).
- Lift the outer rim off, (Fig.18.35).
- Lift the tyre of the inner rim, (Fig.18.36).
- Gently get hold of the inner tube just behind the valve.
- Carefully feed the tube out of the tyre, (Fig.18.37).

**NOTE:** Solid tyres are chemically bonded to the wheel rims. These must be changed as a complete assembly.

#### To refit:

- Place the tube inside the tyre and rest it on the outer rim.
- Align the valve stem with the cut out on the rim, (Fig.18.38).
- Face the valve stem outward, (Fig.18.38).
- Place the inner rim over the tyre, tube and outer rim.
- Align the cut out to fit over the valve stem and match it up to the cut out in the outer rim, (Fig.18.38).
- Make sure the stud mounts are in line on both rims.
- Tighten the studs evenly in the sequence shown, going around once to close the rims and then again to tighten fully taking, care not to pinch the tube, (Fig.18.39).
- Slowly inflate to the appropriate pressure.

#### **WARNING!**

- Do not use high pressure air delivery systems such as those found on garage forecourts, to inflate the scooter tyres.
- Always use a new inner tube.





## 18.4 CHECKING THE TYRES

Check the tyres at least once a week for signs of wear and damage.

### Check for:

- Excessive wear on the tyre tread.
- Uneven wear over the surface of the tyre.
- Cuts or holes in the tyre tread.
- Cuts or holes in the tyre walls.
- Sharp objects stuck in the tyre.
- Tyre pressures.
- Tyre studs/nuts are tight.
- Damage to wheel rims.
- Foreign materials/contaminants. (Fig.18.40-18.41)

### WARNING!

- Put the scooter in drive, switch the scooter off and remove the key before carrying out the checks.
- Never use the scooter if the tyres are found to be defective after carrying out the above checks.
- Wear protective gloves if you have to physically touch the tyres or undercarriage and afterwards wash you hands thoroughly.

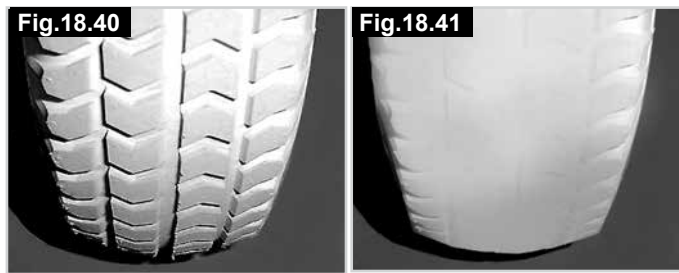

## 18.5 WHEEL SIZES

ELITE <sup>2</sup> PLUS	
356mm (14") Front	V Groove Grey Pneumatic
356mm (14") Rear	Knobby Grey Pneumatic
356mm (14") Front	V Groove Grey Solid
356mm (14") Rear	Knobby Grey Solid
ELITE <sup>2</sup> XS-RS	
310mm (12") Front	Flat profile Pneumatic
310mm (12") Rear	Knobby Grey Pneumatic
310mm (12") Front	Flat profile Solid
310mm (12") Rear	Knobby Grey Solid

## 19.0 Name Plate

The nameplate is located on the seat post of the scooter, as well as on a label in the owner's manual. The nameplate indicates the exact model designation and other technical specifications. Please provide the following pieces of information whenever you have to order replacement parts or to file a claim:

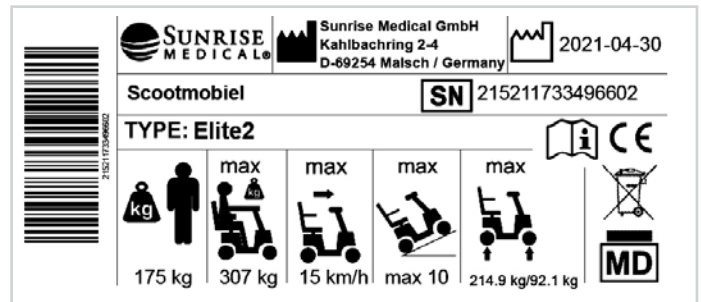
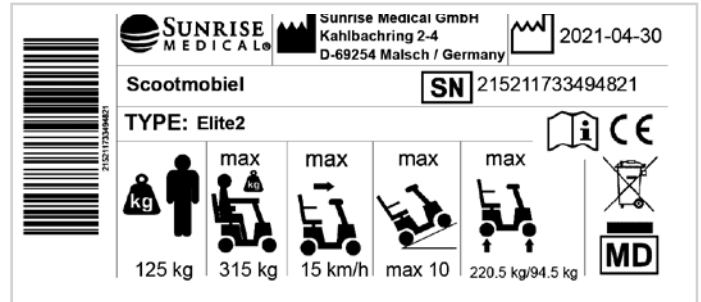

Elite<sup>2</sup> XS / Elite<sup>2</sup> Plus

Product Name/SKU Number.



Maximum safe slope with anti-tip tubes fitted, Depends on wheelchair setting, posture and physical capabilities of the user.



Maximum user weight.



Maximum axle loading.



Maximum total weight.



CE Mark.



Maximum speed.



User's Guide.



Indicates electrical / electronic equipment must be disposed of in accordance with the WEEE directive.



XXXX-XX-XX

Date of manufacture.



Serial number.



This symbol means Medical Device.



Manufacturer's address.

Due to our policy of continuous improvement in the design of our wheelchairs, product specifications may vary slightly from the examples illustrated. All weight/ dimensions and performance data are approximate and provided solely for guidance.

As the manufacturer, SUNRISE MEDICAL, declares that the scooters conform to the Medical Device Regulation (2017/745).

 All wheelchairs must be used in accordance with the manufacturer's guidelines.

Sunrise Medical GmbH  
Kahlbachring 2-4  
69254 Malsch/Heidelberg  
Deutschland  
Tel.: +49 (0) 7253/980-0  
Fax: +49 (0) 7253/980-222  
kundenservice@sunrisemedical.de  
www.SunriseMedical.de



Sunrise Medical S.r.l.  
Via Riva, 20 – Montale  
29122 Piacenza  
Italia  
Tel.: +39 0523 573111  
Fax: +39 0523 570060  
www.SunriseMedical.it

Sunrise Medical AG  
Erlenauweg 17  
CH-3110 Münsingen  
Schweiz/Suisse/Svizzera  
Fon +41 (0)31 958 3838  
Fax +41 (0)31 958 3848  
www.SunriseMedical.ch

Sunrise Medical AS  
Delitoppen 3  
1540 Vestby  
Norge  
Telefon: +47 66 96 38 00  
post@sunrisemedical.no  
www.SunriseMedical.no

Sunrise Medical AB  
Neogatan 5  
431 53 Mölndal  
Sweden  
Tel.: +46 (0)31 748 37 00  
post@sunrisemedical.se  
www.SunriseMedical.se

MEDICCO s.r.o.  
H – Park, Heršpická 1013/11d,  
639 00 Brno  
Czech Republic  
Tel.: (+420) 547 250 955  
Fax: (+420) 547 250 956  
www.medicco.cz  
info@medicco.cz  
Bezplatná linka 800 900 809

Sunrise Medical Aps  
Mårkærvej 5-9  
2630 Taastrup  
Denmark  
+45 70 22 43 49  
info@sunrisemedical.dk  
www.Sunrisemedical.dk

Sunrise Medical Australia  
11 Daniel Street  
Wetherill Park NSW 2164  
Australia  
Ph: +61 2 9678 6600  
enquiries@sunrisemedical.com.au  
www.SunriseMedical.com.au

Sunrise Medical  
North American Headquarters  
2842 Business Park Avenue  
Fresno, CA, 93727, USA  
(800) 333-4000  
(800) 300-7502  
www.SunriseMedical.com



Sunrise Medical GmbH  
Kahlbachring 2-4  
69254 Malsch/Heidelberg  
Deutschland  
Tel.: +49 (0) 7253/980-0  
Fax: +49 (0) 7253/980-222  
www.SunriseMedical.de

Sunrise Medical  
Thorns Road  
Brierley Hill  
West Midlands  
DY5 2LD  
England  
Phone: 0845 605 66 88  
Fax: 0845 605 66 89  
www.SunriseMedical.co.uk

Sunrise Medical S.L.  
Polígono Bakiola, 41  
48498 Arrankudiaga – Vizcaya  
España  
Tel.: +34 (0) 902142434  
Fax: +34 (0) 946481575  
www.SunriseMedical.es

Sunrise Medical Poland  
Sp. z o.o.  
ul. Elektronowa 6,  
94-103 Łódź  
Polska  
Telefon: + 48 42 275 83 38  
Fax: + 48 42 209 35 23  
E-mail: pl@sunrisemedical.de  
www.Sunrise-Medical.pl

Sunrise Medical Logistics B.V.  
Groningenhaven 18-20  
3433 PE NIEUWEGEIN  
The Netherlands  
T: +31 (0)30 – 60 82 100  
F: +31 (0)30 – 60 55 880  
E: info@sunrisemedical.nl  
www.SunriseMedical.nl

Sunrise Medical HCM B.V.  
Vossenbeemd 104  
5705 CL Helmond  
The Netherlands  
T: +31 (0)492 593 888  
E: customerservice@sunrisemedical.nl  
www.SunriseMedical.nl  
www.SunriseMedical.eu  
(International)

Sunrise Medical S.A.S  
ZAC de la Vrillonnerie  
17 Rue Mickaël Faraday  
37170 Chambray-Lès-Tours  
Tel : + 33 (0) 247554400  
Fax : +30 (0) 247554403  
www.sunrisemedical.fr

