

Emys

Technical sheet

English

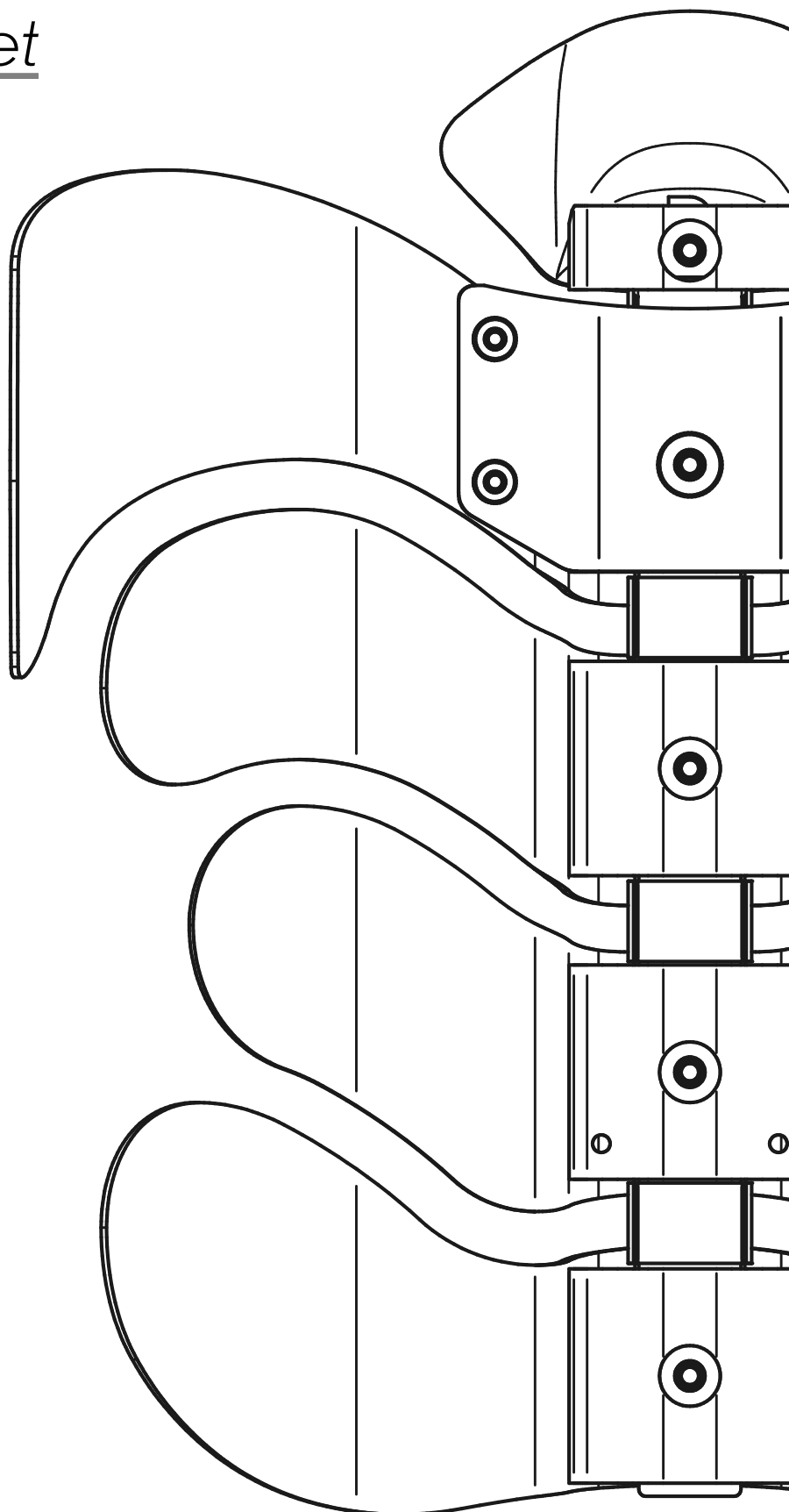



Main features

Comfort

Each pad is made of foam, with a removable and washable covering realized with technical material for maximal comfort.

Design

Minimal and soft lines highlight an hi-tech design blending beauty and ergonomics.

New: discover the high-visibility stripes for your safety.



Fresh feel

The space between the slats and the specific materials used for the pads, make the backrest highly breathable.

Flexibility

The central armonic spring steels and the modular system, allow the backrest to flex giving freedom of movement to the user.

New: with EMYS you can decide the level of flexibility of the backrest!

Height

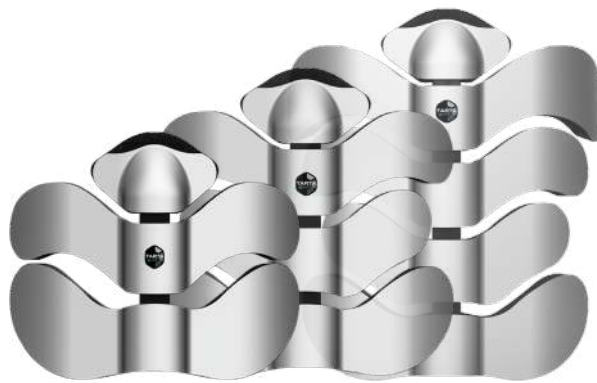



| 3V | 4V | 5V

- | **3 Vertebrae** 27 cm
- | **4 Vertebrae** 35 cm
- | **5 Vertebrae** 43 cm

Size



| **M** | **L** | **XL** |

-  | **M** for wheelchairs from 35 to 40 cm
-  | **L** for wheelchairs from 38 to 43 cm
-  | **XL** for wheelchairs from 40 to 45 cm

Depth



STANDARD

5,5 cm



CONTOUR

9 cm



DEEP-CONTOUR







14,5 cm

Aluminum is the most adaptable material to make each slide of the backrest suit the user's body!





Models

	STANDARD	CONTOUR	DEEP-CONTOUR
3V M-L-XL			/
4V M-L-XL			
5V M-L-XL	/		



1 Press



2 Press to bend the staff. Maximum excursion 3 cm.

3 heights

3 sizes

3 depths

21 models





Adjustable clamp for rigid frame wheelchairs

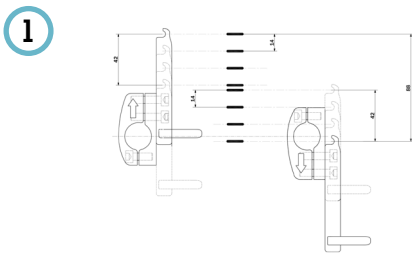

Features:

- 1 height adjustment
- 2 rotation adjustment
- 3 depth adjustment
- 4 tube diameter: 19-22-25mm
- 5 easy unhook
- 6 safety rubber band

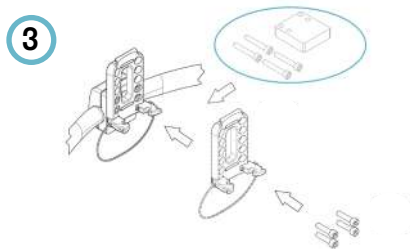
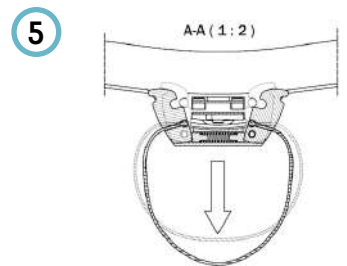
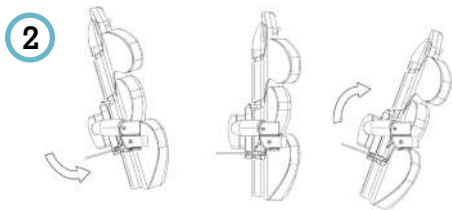
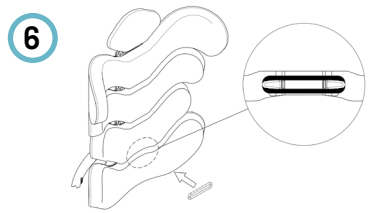



Adjustable clamp for folding wheelchairs

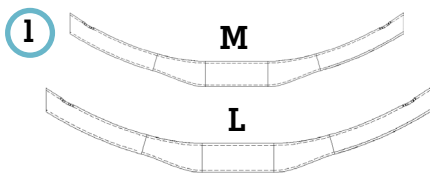
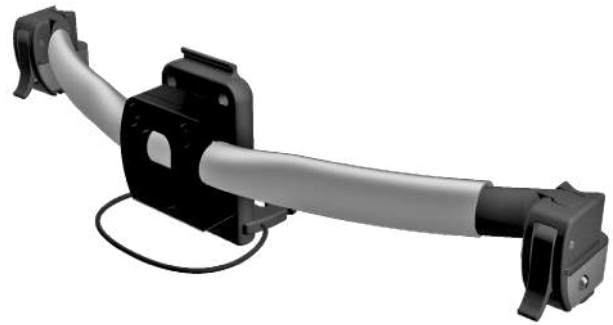

Features:

- ① rigidizer bar to specify:
M: 36 - 41 cm **L:** 41 - 46 cm
- ② hose clamp: 19-21 / 22-25 mm
- ③ height adjustment
- ④ depth adjustment
- ⑤ rotation adjustment
- ⑥ easy unhook
- ⑦ safety rubber band

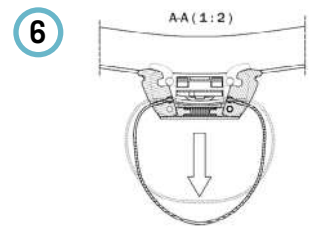
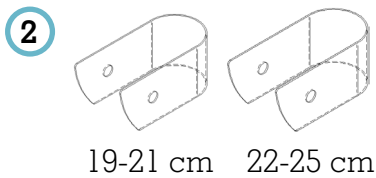
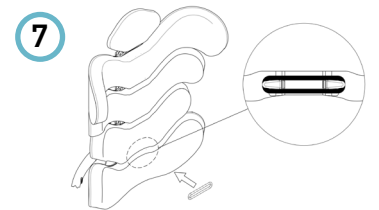

③

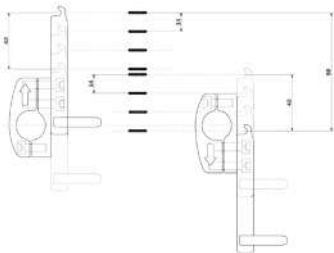

④

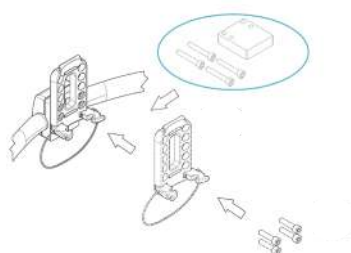

⑤

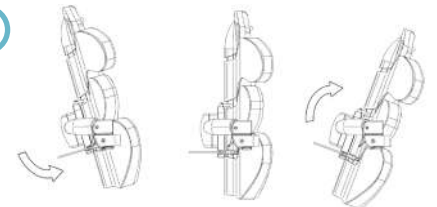



Finishing



"A" bent slat
for a **more comfortable support**.

Upper pocket pads

for a greater adherence to the slats and to **intensify the softness** of the backrest.

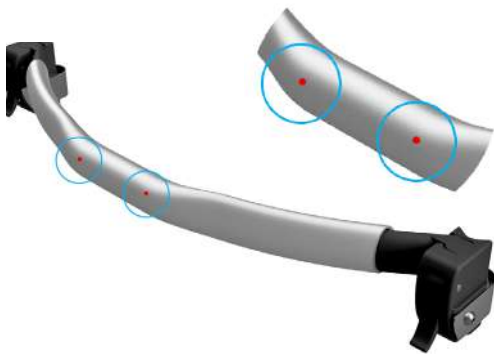

Balance points

on the rigidizer bar to simplify the balance of the clamp for folding wheelchairs.

2 rubber tubes (internal diameter 22mm)
easy adaptables to every wheelchair **to protect the backrest**.



Highly breathable pads

removable and **washable** at 30°.



Choose your **style.**



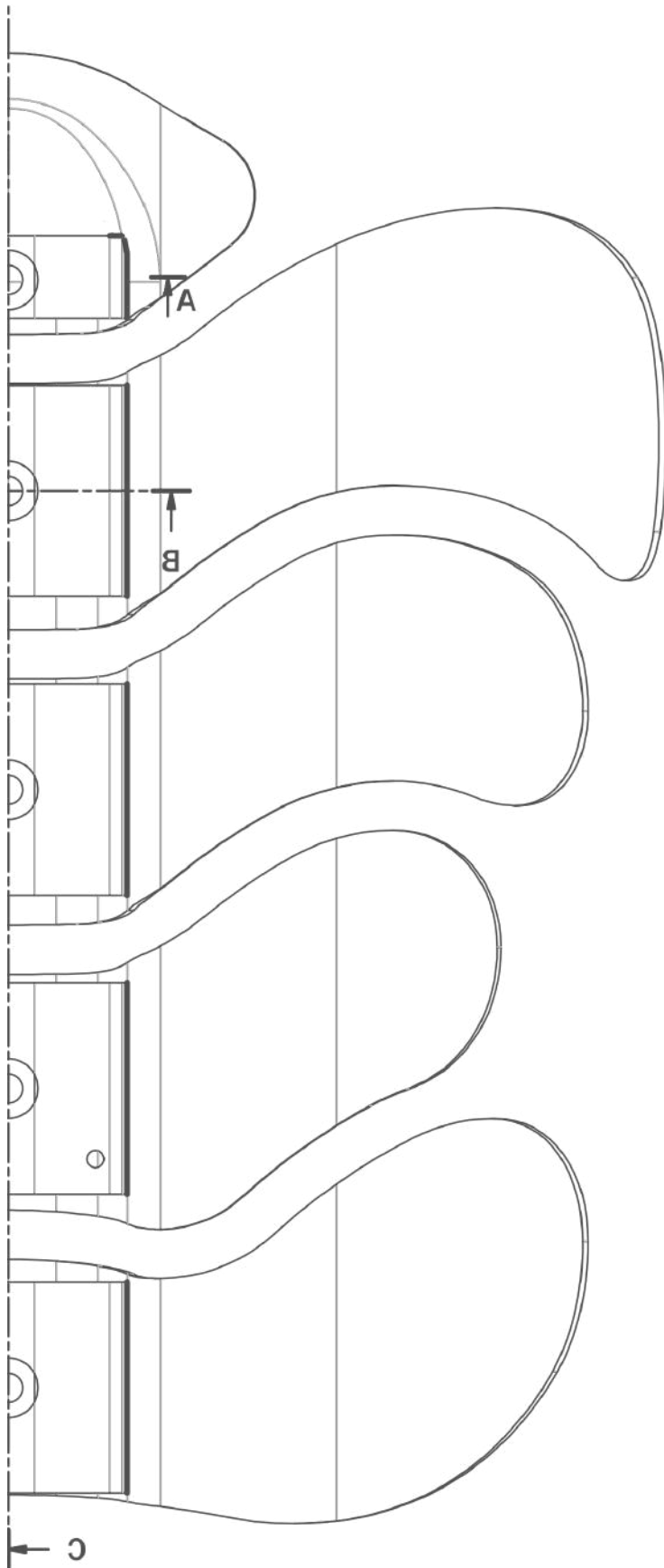

Questions?
Info?
Help?

Visit our website:
www.tartadesign.it

or contact us at:
info@tartadesign.it

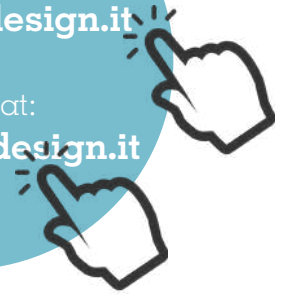

Tarta Design srl

Via Cottonificio, 56
33037 Pasiàn di Prato
Udine - Italy
T +39 0432 722 533
F +39 0432 542 920

www.tartadesign.it
info@tartadesign.it