

TREKINETIC  
USER MANUAL  
11<sup>TH</sup> EDITION



GTE MK II

# Contents

1. Introduction.....	4
2. Safety Notice .....	5
3. Unpacking Your GTE.....	7
4. Getting To Know Your GTE.....	17
Quick Start Guide .....	17
Folding the chair for travel (Wheels On).....	26
Folding the chair for travel (Wheels Off) .....	30
Unfolding the chair for use.....	37
5. Battery and Charging .....	42
NMH (Nickel Metal Hydride) Battery Charging.....	44
Li-Ion (Lithium-ion) Battery Charging.....	45
6. Helpful Tips .....	46
Kerbs .....	46
Side Plates .....	46
Seat Liner & Pressure Cushions .....	47
Rear Wheel Punctures.....	47
Front Wheel Punctures .....	48
Cleaning.....	48
Air Travel .....	49
Immobiliser activation and deactivation.....	54
7. Maintenance .....	55
General .....	55
Tyre Pressures.....	56
Footrest.....	56
Rear Castor .....	56

Servicing.....	57
Beach Use.....	57
Nameplate.....	58
Torque Settings.....	58
8. Troubleshooting.....	58
9. Appendix 1: Advanced Trouble Shooting.....	61

# 1. Introduction

## Welcome to the team

Thank you for choosing Trekinetic for your new powerchair and welcome to the revolution! You are now part of a select group of individuals that have joined us in turning the wheelchair industry on its head and have chosen a life of adventure, excitement and independence.

We are delighted that you chose the revolutionary Trekinetic GTE All Terrain Wheelchair and are confident that you will love your new product. The GTE has been designed to be different, but the unique configuration will soon become second nature and open up access to places you simply couldn't access with a traditional wheelchair. This user manual offers important advice and ideas so that you can get the most out of your new wheelchair, so please read it carefully before use. Please contact your local dealer if you have any questions relating to the use, maintenance or safety of the wheelchair.

Where you do not have a local dealer, please contact us by phone or email as below. If you could have your chassis number (which you can find under the seat) to hand when contacting us, that will help us identify your specific wheelchair.

E-mail: [info@trekinetic.com](mailto:info@trekinetic.com)

Telephone: +44 (0)1442 252700

## Warranty Registration

Your new wheelchair is covered by a 1-year manufacturers return to base warranty. To validate your warranty please head to the below link to register your details:

<https://trekinetic.com/warranty-registration/>

If you have any issue registering your details online, please call us or email using the above contact information.

## Share Your Experience

We'd love to see and hear how you're getting on with your Trekinetic wheelchair and so would the rest of the Trekinetic community! Seeing photos of our customers all over the world makes what we do all the more worthwhile, but it also raises awareness of our products and allows others to see the chairs being used.

The easiest way to share your stories is to tag us on social media (Facebook, Instagram or Twitter) using our handle **@trekinetic** and hashtag **#teamtrekinetic**

If you don't use social media, please feel free to email your pictures and video to us using the above email address and we'll share them for you (with your permission of course).

## 2. Safety Notice

This wheelchair has been designed to the highest standards with a specific focus on user safety. The revolutionary Trekinetic wheelchair system has been independently tested to ensure it meets or exceeds current strength and fatigue standards but nevertheless, users may put themselves at risk by improperly using their wheelchair or exceeding recommended guidelines.

Many actions are different compared to a traditional four-wheel, rear driven chair so please allow yourself time to explore these in a safe environment, ideally with a companion. Get to know how it performs and test the seat in various positions, for example you will find that the chair is more stable downhill with the seat reclined.

Unlike a conventional four wheeled wheelchair, our unique three-wheel design all but ensures you will have a wheel in contact with the ground, making it especially stable off road. You may find that you can go across certain terrains at higher speeds than many other chairs, however, even the Trekinetic GTE has its limits, so always be mindful, that as speed rises, stability and safety decreases.

One of the most unstable situations for any vehicle is turning sharply on hills, uneven terrain, on cambered surfaces, high speed or at worse any combination of these. So please remember the general rule\*: Going **uphill** - seat **backrest upright**. Going **downhill** -seat **backrest down** (fully reclined). The chair will always be more stable with the wheels set in the MEAN position and you should always

ensure that the footrest is fully extended and locked in position by pressing down firmly.

\*This is a general rule and cannot take account of all occupant weight distributions. Users need to determine the position they feel is the most suitable. If in any doubt, please contact the factory or you dealer for further advice. Please also beware of potholes. They can cause instability, just as well as bumps!

Just like a racing driver, for the most efficient progress, use the controls with the utmost sensitivity and precision. Take time to learn these skills and you will be rewarded with improved ability in many conditions, over many different terrains.

When getting in and out of the chair, always make sure the levers beside the front wheels are down in the **POWER** position and the joystick is powered off, as this will lock the wheels in position and eliminate the chance of the chair moving. Please note that the Trekinetic GTE has not been crash tested and therefore is not suitable for user in chair transport in a motor vehicle.

Always use ramps if available and do not descend or turn at high speed. Become acquainted with the kerb climbing techniques and do not strike them at speed. Make a point of being aware of the rear castor's orientation. Do not expose the Carbon Fibre structure to naked flames. The rear shock absorber contains high pressure Nitrogen gas. Under no circumstances apply heat, force or try to dismantle this unit. In the event of malfunction or end of life, contact your dealer or the factory for advice. Before use, please read all sections of this manual carefully. If there is anything you don't understand or need explaining, please reach out to your local dealer.

We strongly recommend having the chair serviced after the first 6 months of use by an accredited Trekinetic service centre. From there on, we recommend your Trekinetic wheelchair is serviced every 6-12 months depending on usage to ensure optimum working condition. If you feel confident enough to service the chair yourself, please contact Trekinetic directly who will provide a Service Schedule for you to follow.

The maximum user weight is 114 kg and only one person may be carried. Although the GTE is shower proof and includes IP66 rated electrical connectors, like all electrical items it should not be exposed for prolonged periods of time. Under no circumstances should the chair or any part of it be immersed in water. Excess exposure to water may cause damage to the electrical circuits and damaged caused by extensive water ingress will not be covered warranty.

The Trekinetic GTE is classified as a Class II vehicle and is therefore not to be used on the road.

### 3. Unpacking Your GTE

If your new GTE has been shipped to you in a container, please read on to understand how to unpack your GTE.

If your GTE chair has been delivered fully assembled by a dealer please skip to [Getting To Know Your GTE](#).

Your GTE has been securely packaged to avoid damage during transit and will likely need two strong people to lift once delivered. Trekinetic deliveries are fully insured but your first job is to check that the container looks to be in good condition (as below), If there is any damage, like holes or big dents in the side of the carton you must take pictures as proof. This way, in the rare event of damage in transit, we will be able to claim in full against our insurers for any repairs or part replacement.



#### Unpacking

All Trekinetic wheelchairs ship directly from our facility in the UK. Whilst all containers are shipped securely, there are some differences in how we ship them, i.e. International shipments will likely contain a solid wood frame whereas domestic shipments normally don't. Hopefully this should become obvious when reading the below instructions.

1. Place the box on the floor with the wooden pallet at the base as per the picture above.
2. Carefully cut the 4 metal straps and remove the lid.
3. Set aside the protection plates on top and remove the upper packaging material
4. Slide the central cardboard sleeve upwards, trying not to tear it as it can be reused if you ever need to ship the entire chair back to us.
5. If the chair has been delivered outside the UK and you can see the wooden frame inside, use a screwdriver (not supplied) to undo the screws in each of the four legs at the base. If not, skip to step 7.
6. Lift up and set aside the wooden structure with the wheel attached.
7. Cut the white cable ties to free the wheels and remove them along with the rest of the packaging
8. Cut the three white cable ties attaching the main body to the base.
9. Set the main body of the GTE on the floor and move the packaging out of the way.

## Assembly

1. Typically, all the wheels will be removed during transit and look like the below picture, but in certain situations the wheels may be left on. If that is the case, please just skip the relevant wheel assembly section(s).





2. To assemble the rear castor, ensure that the armrests are folded back and carefully turn the chair over so it's upside down. It's best to do this on a soft surface to avoid scratching the seat.

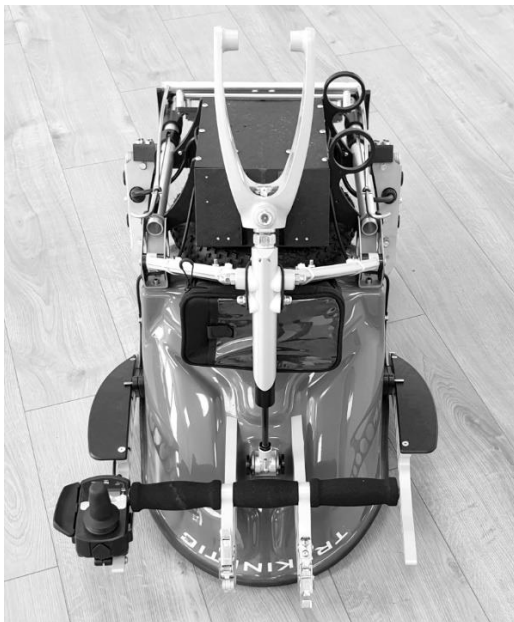

3. To assemble the rear castor, you will need an 8mm A/F Allen Key. If you have a Safari kit, choose the largest of the three Allen keys in the bag. If you don't have the Safari kit option, there will be a key taped to the base of the container.
4. Looking at the chair as in the above picture slide the Allen key through the threaded hole on the left-hand side. Please note that rear castor assembly can rotate, so do ensure that it is in the below position with the large adjustment screw (circled in red below) facing towards you. Then slide one of the silver washers over the end of the Allen key.

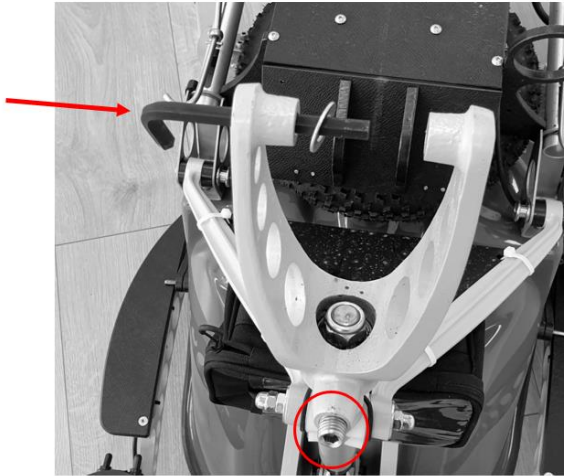

5. Next, locate the rear wheel castor and slide it over the Allen key followed by the second washer on the other side of the wheel. You should now have a metal washer either side of the wheel and inside of the castor fork. This is a bit fiddly, but it will fit, and you'll only need to do this again when changing the rear wheel.
6. Now this is in place, take the large silver bolt and push it through the rear castor from the other (right hand) side, sliding out the Allen key as it goes through. You may need to jiggle the rear castor about a bit to ensure it's gone through.



Once you can't push it through any further, fully remove the Allen key and use it to tighten the bolt on the other side.

7. Turn the chair back over.
8. Ensure the rear strut is connected to the bracket on the back of the seat by squeezing the two plastic buttons on either side and inserting it into the metal clasp. Occasionally it can twist slightly, so ensure it is straight and fully engaged into the clasp. You should hear a satisfying click when inserted correctly.



9. Fully extend the footplate (making sure to unhook the elastic over the footplate lever first (if you have the upgraded footplate)). This will take two hands and may need support from another person. You can balance the seat by holding the front of the seat. At the same time unfold the jacks (black plastic triangular shaped pieces at the edge of the footplate) so that the footplate now rests on the jacks as below:



10. You can then fold down the armrests and extend and lock the folding handlebars (if applicable) as below.



To lock the folding handlebars, first locate the two halves of the handlebar which fit together, then hook the clasp over the catch and pull the clasp back to lock it. This may be a bit stiff but has been designed to be extremely strong to avoid damage. In the above image you can see the nearside clasp locked into position and the far clasp hooked over the catch and ready to be pulled back into the locked position.

11. Next, activate the shock absorber by pressing the silver switch upwards. The chair should automatically rise back into position.

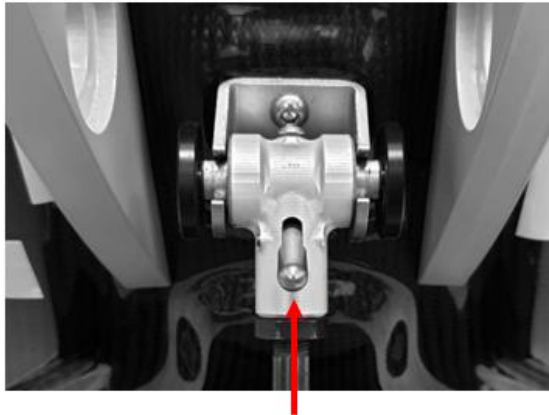

12. After removing the joystick from the packaging, you need to clamp it in the holder. Using the smaller Allen key, loosen the two bolts holding the clamp together until there is enough space to insert the ball joint under the joystick.



13. Once in, tighten the bolts and connect the cable under the armrest (as below), making sure to align it by looking inside the connectors.



14. It doesn't matter which order you put the wheels on but you must make sure that the right hand wheel connects to the right hand side of the chair and the left hand wheel connects to the left hand side of the chair. This is the side as you would see it when sitting in the chair. The wheels are labelled on the inside of the wheel and the chair also has a similar notation on the respective bracket.

RH = Right hand side

LH = Left Hand side

15. Once you have selected the correct wheel, line up the longer central pin with the central hole and the shorter upper pin at the top with the upper hole on the side bracket.

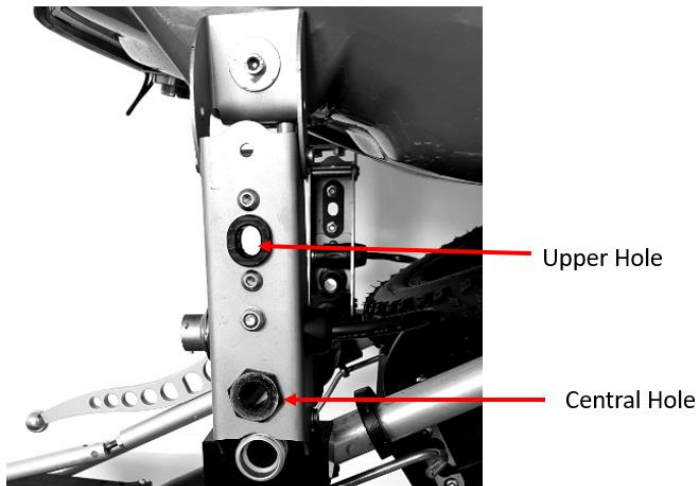
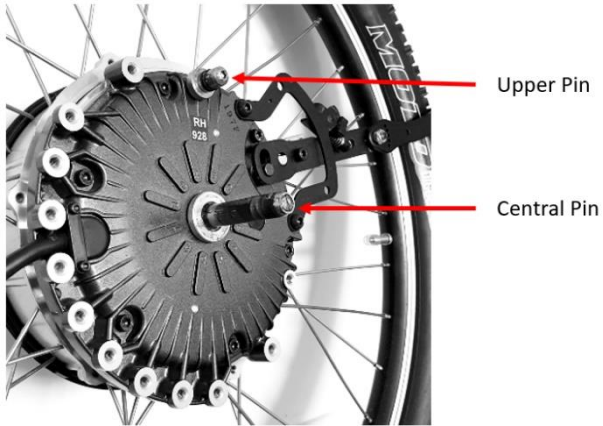

16. Press the black button in the centre of the outside of the wheel and slide the pins into the respective holes.



17. Repeat with the other wheel.
18. Align one connector at a time by lining up the LH or RH sticker so it is at the 12 o'clock position. With the LH connector, you can see that the two holes in the connector plug need to be lined up with the two holes in the connector socket.



*Left hand side (LH) connectors*



*Right hand side (RH) connectors*

If the LH/RH sticker has been removed, you can line the connector up by looking at the pins within the connector to see where they fit.

19. Gently press the connector into position and then turn the plastic collar clockwise until it secures into position. It is essential that this is not done with excess force or you could damage the connection. Repeat for both wheels.



20. Activate the shock absorber again by pressing the silver switch upwards and push the handlebars downwards to recline the seat and lift the footplate up.



21. Fold back the plastic jacks on the footplate and If required push the footplate back in for transferring
22. Activate the shock absorber a final time to bring the seat back to an un upright position or set it at the preferred position for use.
23. Switch on the power by flipping the switch on the right-hand side and the display should illuminate with the letters FL for 'Full Battery'. If the display shows 'C1' it means one or both 'Manual/Power' levers are upwards and in manual mode. Push them down and the error code should disappear.
24. You are now ready to go!

## 4. Getting To Know Your GTE

### Quick Start Guide

Assuming your chair has arrived fully assembled the first step is to ensure it's ready before getting in!

#### 1. Choose MANUAL or POWER

Your Trekinetic GTE is one of the only powerchairs on the market that can be operated as a manual chair as well. To switch from MANUAL to POWER simply switch the levers beside the front wheels between the two positions, making sure that each lever is in the same position. When the chair is in MANUAL mode, it can be self-propelled or pushed from behind although it is worth noting **there are no brakes in this mode**. In MANUAL mode the chair can be moved or stopped by simply pushing or stopping the front wheels by hand, or with the help of an assistant.

For POWER use, both levers need to be fully engaged in the lower position or you will see a C1 error when the joystick is switched on. If you do encounter this error code, please just ensure the levers are in the right position and the error should clear. If the problem persists, please power the joystick off and on again or speak to your local dealer if you need further support.



To get started we're going to enter POWER mode, so the first step is to ensure the MANUAL/POWER lever beside each front wheel is clicked downwards in the POWER position. This will engage the electromagnetic brake and ensures the chair won't start rolling away when you try and sit down.

## 2. Insert Battery

Your Trekinetic GTE comes with either the standard Nickel Metal Hydride (NMH) or the longer-range Lithium Ion (Li-ion) battery depending on which option you have chosen. The Lithium Ion battery is designed to be charged in the chair but the Nickel Metal Hydride option needs removing and has a separate charging dock.

Whilst the chair can be operated as a manual chair it's normally a good idea to have a fully charged battery with you just in case so please ensure that the battery is inserted into the battery box below the seat with the yellow button on the left hand side. The battery should slide in and click into place when it connects at the base. To remove, simply press the yellow button and slide out.



(NMH Variant)

### 3. Secure Connectors

Even if your chair has been delivered fully assembled it's always a good idea to check that the connectors are done up securely. The connectors ensure that the motors in the wheels are connected to the joystick wiring but do need connecting/disconnecting whenever the wheels are removed and attached.



It is important to ensure that you have the correct wheel as they are marked LH and RH for 'Left Hand' and 'Right Hand' respectively. With the correct wheels attached, line up the connector by ensuring the LH or RH label on the connector is facing upwards push on gently and lock by turning the collar of the connector a quarter turn clockwise to secure. Excessive force with the connectors risks damaging one of more of the pins which can cause an electrical issue. If you think this has occurred, please contact your local dealer.

Familiarise yourself how the connectors are designed to align, by looking inside both corresponding connectors.



*Left hand side (LH) connectors*



*Right hand side (RH) connectors*

You will see a selection of pins and holes that need to align for a secure connection. You should be able to feel the connector line up and then as you gently turn the collar, it will secure the connection. To undo, reverse the process and unlock with a quarter turn of the collar anti-clockwise before gently pulling the connector off.

If you power on the joystick before securely attaching the connectors you will see an E1/18 error on the display. If this happens, simply turn off the joystick and attach the connectors before powering back on.

If these connections are forcibly removed (or attached) you risk damaging the pins which may stop the chair from working altogether.

#### **4. Armrests**

Your GTE comes with folding armrests which can be used as support for getting in or out of the chair. We recommend starting with them down, but you can simply fold them back if you feel they're getting in the way.



## 5. Seat Angle

Our patented, rear shock absorber helps ensure a smooth ride at all time, while also acting as a tilt in space mechanism to alter the angle of the seat and change the weight distribution in the chair.

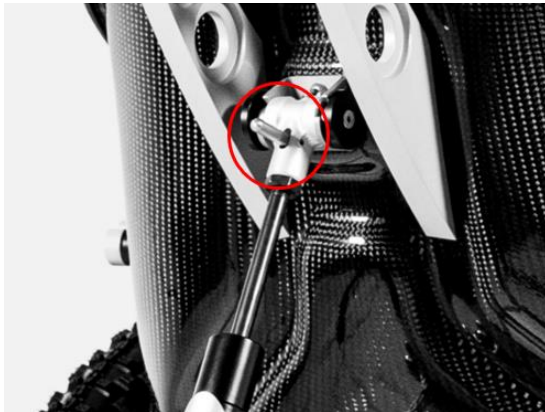

The shock absorber will engage automatically to cushion you from any lumps and bumps that the rear wheel encounters but it can also be manually engaged to change the angle of the seat and consequently the height of the footplate.

To manually engage the shock absorber and engage the tilt in space mechanism simply press upwards on the metal 'switch' that protrudes outwards. If nobody is sitting in the chair, activating the shock absorber will cause the chair to right itself and arrive at the most upright position. Similarly activating the shock absorber whilst pushing down on the top of the seat will cause the seat to recline. This can

be done whilst in the chair by either leaning backwards or tipping forwards to change the seating position. Some users may need support in doing this, but the rear wishbone can be used to 'pull down or push off' if you're unable to move the seat whilst in the chair. Some users prefer to use the chair in a half-way position which also works well in most scenarios.

We recommend having the chair in a reclined position when going downhill and an upright position when going uphill to improve weight distribution. You will also find that having the chair reclined provides increased ground clearance when going over rougher terrain.

## 6. Varicam System

Our patented Varicam system allows you to change the angle of the wheels by simply turning a bar under the seat. Set the bar to 'MEAN' for extra stable, off road use and 'LEAN' for the narrowest footprint and indoor use. 0-8 degrees in 10 seconds. Zero tools required.

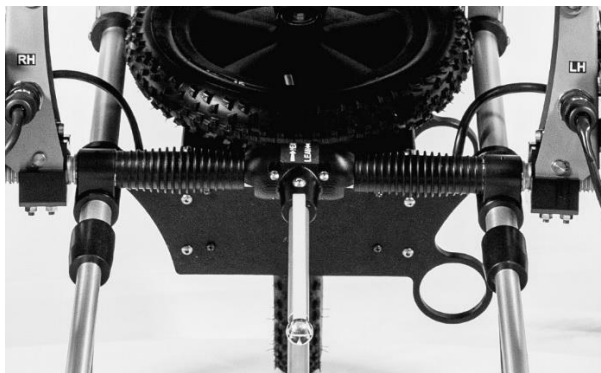

The Trekkinetic GTE has been designed to be as stable as possible off road but as practical as possible when used indoors and around town. For normal day to day use, the chair can be left in the 'LEAN' position which means the wheels are vertical and you should be able to fit through all but the narrowest of doorways. If you are venturing off-road though we recommend switching to 'MEAN' mode which changes the angle of the wheels by 8 degrees and makes the chair even more stable over rougher terrain.

To change the camber simply turn the camber bar clockwise for LEAN or anti-clockwise for MEAN, following the arrows on the centre of the bar.



Please note that the adjustment of the camber **cannot be done** with the user in the chair and camber must be fully set in the MEAN or LEAN positions. This means tightening the bar at either setting.

We recommend selecting the MEAN position wherever possible as this offers the maximum stability. Do not alter the setting up screws in the black plastic blocks at either end of the camber bar. These are for setting at service intervals only.

When using LEAN mode, small vibrations from daily use can sometimes cause the camber to unwind slightly. To combat this, we recommend checking the tightness of the camber bar regularly. If this becomes a persistent issue and the you feel the chair only needs to be locked in one position (I.e. not variable) we offer a camber lock system which can be fitted to the chair. Please speak to your local dealer if you would like to explore this option in more detail.

## 7. Footplate

Next up, you want to get the footplate out of the way. The below example shows the upgraded locking and retracting footplate, but the same motion applies to the standard footplate. To raise the footplate, either pull the lever upwards (for the locking and retracting footplate) or push the footplate in by hand (or foot) if you have the standard footplate. If you have the lever operated option, there is an elastic loop just under the seat to hold the lever in place should you need it. This is more commonly used when transporting the GTE, but it will stop the footplate sliding back down.



You are now ready to get into your GTE! Transferring into the GTE is simpler than it may look, just ensure that you get as close as possible to the seat, by positioning yourself at an angle of about 45 degrees. Certain users may need support with this process.

Once you're in, slide the footplate back down, ensure it's in the locked position, fold the armrests are down and you're almost ready to go!

## 8. Joystick Operation

The Trekinetic GTE is fitted with a programmable 5 speed electronic joystick with power/speed toggle switches and push operated horn. The joystick ships with a default 'Sport' setting but there is an option to re-program the joystick if you are finding it difficult to control. If this is the case please contact your dealer (or the factory directly if you don't have a local dealer) for further detail. Below are some examples of the settings that can be adjusted:

- Top Speed (can be reduced for forward/backward)
- Turning Speed
- Torque (max torque required for steep hill climbing but light users may find the chair slightly jerky)
- Acceleration (reducing this will slow down the rate at which the chair reaches top speed)



- Deceleration (reducing this can bring the chair to a smoother stop when releasing the joystick suddenly)
- Range (for users where the hand cannot be moved fully)
- Filter (for users who's hands shake)

There's also a USB port at the front for charging your phone or tablet.



To get started flip the power switch on the right upwards to power on the device. The display will show the battery level on the central display in large letters. This is typically represented as a two-digit percentage figure apart from when the battery is full, and the display shows FL. When the chair is not in use, power off the joystick and flip the Manual/Power levers down (into the Power position) to conserve battery and engage the electromagnetic brake.

The left switch controls the speed of your GTE and subsequently it's power. We recommend flicking the speed switch downwards until you get to gear 1 (1 bar) to start with. Gears 1 to 3 are typically more than enough for indoor use but if you're outdoors your GTE will provide maximum power and subsequently speed in gear 5.

**Caution:** Always operate the joystick as gently and as smoothly as possible. Letting go of the joystick abruptly, brings the risk of the chair tipping forward when the electromagnetic brakes automatically come on. (Reclining the seat will reduce this effect as the weight distribution is slightly further back). The footplate on the GTE has been designed to act as an anti-tip mechanism but we still recommend great care when descending hills where the risk is at its greatest. When going downhill, recline the seat and select gear 1 or 2 to ensure a smooth descent. When going uphill, use the chair in the upright position and select gear 4 or 5 for maximum power.

## 9. Time for a test drive!

Your GTE is now ready to go. Please take it easy for the first few days whilst you get accustomed to how the chair performs in different scenarios. Even if you're a seasoned wheelchair user, your Trekinetic GTE has a lot of differences to conventional wheelchairs and may take some getting used to! That said, we are confident that you will master the basics very quickly and will enjoy your new GTE almost immediately.

### Folding the chair for travel (Wheels On)

Your Trekinetic GTE can be folded down with and without the wheels on. Firstly, we'll go through how to fold it down with the front wheels still on.

1. First off, set the lever beside the front wheels to POWER. This will stop the chair rolling away.

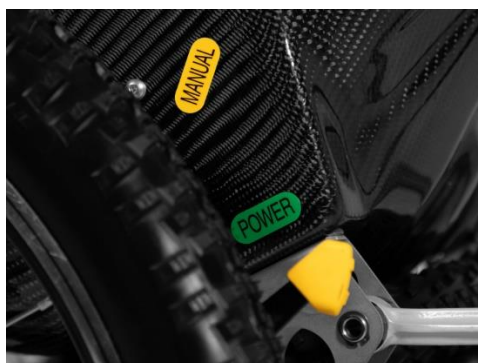

2. Set the camber to the LEAN position by turning the camber bar clockwise. The wheels should now be in a vertical position.



3. Retract footplate and hook elastic loop under seat around footplate handle (if using upgraded footplate).



4. Recline the seat by activating the shock absorber and pressing down until the shock absorber is fully compressed.



5. Unclasp the locks on the folding handlebars (not applicable to standard non-folding handlebars) and fold handlebars downwards



6. Fold armrests backward



7. Disassemble rear castor assembly. To release the rear strut, squeeze the two plastic buttons either side of the head of the shock absorber and pull the head towards you and out of the clasp.



(When replacing this structure, simply reverse the initial movement, squeezing the two plastic buttons on either site and inserting it back into the metal clasp. Occasionally it can twist slightly, so ensure it is straight and fully engaged into the clasp. You should hear a satisfying click when inserted correctly.)

8. Once this is separated, fold down the strut behind the seat, docking the rear wheel into the slot in the back of the battery box and resting the top of the shock absorber against the top of the seat. There is another piece of elastic at the base of the rear strut which will hook over the clasp on the back of the seat. This will stop the rear wheel assembly from dropping down whilst the wheelchair is transported (see picture below).



9. It should now look like as below and is ready for transport. Your GTE can now be lifted into a vehicle or you can attach our hoist kit if using a mechanical hoist system. If the chair is being lifted by hand and is still too heavy, you can also remove the battery which will take out some of the weight.



## Folding the chair for travel (Wheels Off)

You Trekkinetic GTE can be folded down with and without the wheels on. The below sequence is how to fold it down with the front wheels removed.

1. First off, set the lever beside the front wheels to POWER. This will stop the chair rolling away and also means the lever won't spin when the wheels are removed.



2. Set the camber to the LEAN position by turning the camber bar clockwise. The wheels should now be in a vertical position.



3. Extend the footplate using either the lever or by manually pulling out the footplate.



4. Recline seat by activating shock absorber and pushing the seat back until the shock absorber is fully compressed.



5. Now we're going to use the shock absorber and the jacks on the footplate to lift the front wheels off the ground so it's nice and easy to remove them. With the seat reclined, there is space to fold down the black triangular pieces either side of the footplate as below. Once these are folded down, engage the shock absorber again, but this time, let it come up so it's fully upright (you may need to push it up a little bit for the last part). The front wheels should now be off the ground.



6. Remove the connectors on both wheels by twisting the collar anti-clockwise until it is free then remove the connector. **Caution:** Pulling out the connector before the collar is undone can cause damage to the connector





7. Once the connectors are removed, push the black pin in the centre of the wheel and gently pull each wheel off. The chair will balance on the jack stand without either of the front wheels on.



8. Your chair should now look like this!



10. Fold armrests backward



11. Unclasp locks on folding handlebars (not applicable to standard non-folding handlebars) and fold handlebars downwards



12. Recline seat using shock absorber until the shock absorber is fully depressed.



13. Disassemble rear wheel assembly. To release the rear strut, squeeze the two plastic buttons either side of the head of the shock absorber and pull the head towards you and out of the clasp.



(When replacing this structure, simply reverse the initial movement, squeezing the two plastic buttons on either side and inserting it back into the metal clasp. Occasionally it can twist slightly, so ensure it is straight and fully engaged into the clasp. You should hear a satisfying click when inserted correctly.)

Once this is separated, fold down the strut behind the seat, docking the rear wheel into the slot in the back of the battery box and resting the top of the shock absorber against the top of the seat. There is another piece of elastic at the base of the rear strut which will hook over the clasp on the back of the seat. This will

stop the rear wheel assembly from dropping down whilst the wheelchair is transported.



14. Holding the chair stable (by grabbing the front lip of the seat) push the footplate back up, securing where applicable. Your GTE should now look as below and is ready to transport! The chair will be more stable with the jacks down, but they can be folded up for transport. If the chair is being lifted by hand and is still too heavy, you can also remove the battery which will take out some of the weight.



## Unfolding the chair for use

To unfold the chair, you simply need go through the folding process above in reverse order, but just in case you've skipped here for a reminder or have forgotten, here's a step by step guide!

1. We will assume that the chair is in the below position with the wheels off but if the wheels are already on you'll just need to unfold the rear castor as per steps 3 and 4 below and perhaps the handlebars as in part 5.



2. Ensuring the jacks are unfolded, fully extend the footplate (making sure to unhook the elastic over the footplate lever first if this option has been selected). This will take two hands and may need support from another person. You can balance the seat by holding the front of the seat.
3. Unclasp the elastic loop that holds the rear castor assembly in place, and pull back the shock absorber gently, releasing the rear castor from where it is docked behind the battery box.

4. Line up the head of the shock absorber then squeeze the two plastic buttons either side to dock it into position on the back of the seat.



Occasionally it can twist slightly, so ensure it is straight and fully engaged into the clasp. You should hear a satisfying click when inserted correctly.

5. You can then fold down the armrests and extend and lock the folding handlebars (if applicable). To lock the folding handlebars, first locate the two halves of the handlebar which fit together, then hook the clasp over the hook and pull the clasp back to lock it. This may be a bit stiff but has been designed to be extremely strong to avoid damage. In the below image you can see the near clasp locked into position and the far clasp looped over the hook and ready to be pulled back into the locked position.

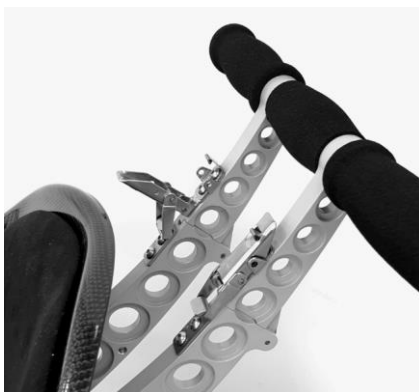

6. Next, activate the shock absorber by pressing the silver switch upwards. The chair should automatically rise back into position and your chair should now look like this:



7. It doesn't matter which order you put the wheels back on but you must make sure that the right hand wheel connects to the right hand side of the chair and the left hand wheel connects to the left hand side of the chair. This is the side as you would see it when sitting in the chair, so the below images show the right-hand wheel facing us. The wheels are labelled on the inside of the wheel.

RH = Right hand.

LH = Left Hand.

8. Once you have selected the correct wheel, line up the longer central pin with the central hole and the shorter upper pin at the top with the upper hole on the side bracket. Press the black button in the centre of the outside of the wheel and slide the pins into the respective holes.

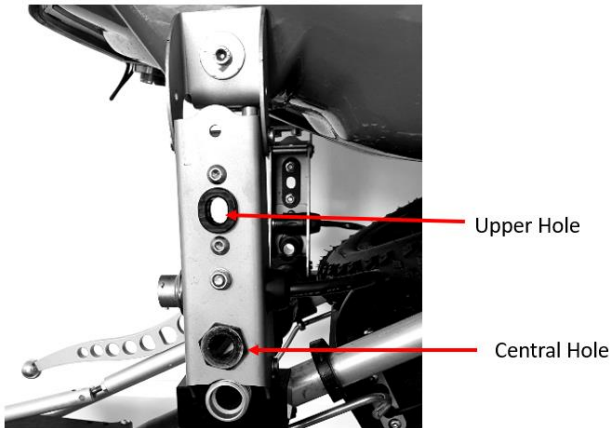
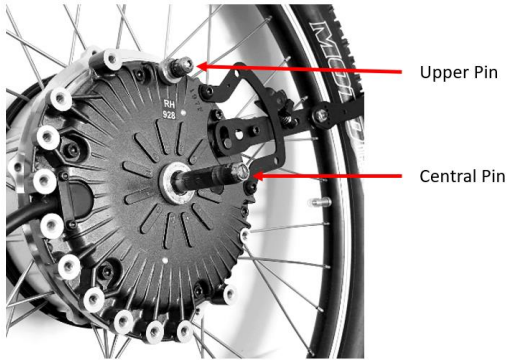



9. Repeat with the other wheel.
10. Align one connector at a time by lining up the LH or RH sticker so it is at the 12 o'clock position. With the LH connector, you can see that the two holes in the connector plug need to be lined up with the two holes in the connector socket.



*Left hand side (LH) connectors*



*Right hand side (RH) connectors*

If the LH/RH sticker has been removed, you can line the pins up by looking at the pins within the connector to see where they fit.

11. Gently press the connector into position and then turn the plastic collar clockwise into it secures into position. It is essential that this is not done forcibly, or you could damage the connection. Repeat for both wheels.



12. Activate shock absorber again by pressing the silver switch upwards and push the handlebars downwards to recline the seat and lift the footplate up.
13. Fold back the plastic jacks on the footplate.
14. Activate the shock absorber a final time to bring the seat back to an upright position or set it at the preferred position for use.
15. If required fold the footplate back in for transferring and you're ready to go!

## 5. Battery and Charging

Your Trekinetic GTE will have been supplied with either the standard Nickel Metal Hydride (NMH) or the optional longer-range Lithium-Ion (Li-ion) sealed battery. The battery is stored under the seat and is accessible from the rear. The size of the battery boxes and charging units are different for each type and a battery may only be charged with the correct charger.



Although both battery types may be removed for charging the Li-ion type can and should ideally be charged in chair.

Both chargers will accept an input voltage between 100 and 240V and therefore suitable for both 110 and 240v without alteration. For UK use the 3-pin plug supplied. If you need a 2 pin plug (for some other countries) you can simply undo the central screw (screwdriver required) that holds the plug together and inside you will find a 2 pin plug as shown below.

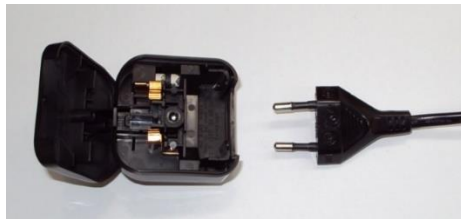

Both batteries will show the remaining power on the top of the battery in the form of 5 illuminated bulbs. Press the green button on the top of the battery to see the power remaining. 5 bulbs illuminated means fully charged and one means charging will be required shortly.

For convenience the power remaining gauge, also appears on the joystick control unit shown as a percentage. Do not confuse this with the 'speed selected' display on the left, shown in bars.

## NMH (Nickel Metal Hydride) Battery Charging

To remove the battery, make sure the joystick power switch is off. Open the battery box rear flap, press the yellow button and withdraw the battery.



Place the battery in the charger and follow the instructions on the charger. The battery will typically enter a 'Fast Charge' state (fully charged in and 2-3 hours), however occasionally the battery will begin a 'Refresh Charge' which takes 8-10 hours. This normally happens after significant use (over many months) and allows the battery to refresh the battery cells, ensuring that the battery can recharge every cell, rather than a smaller percentage, which can lead to poor battery performance (as with most mobile phones, etc.).

The charger will determine which charge is required and inform you by virtue of which lamp is flashing. As the battery charges, the lamps flash and illuminate in succession. When fully charged the unit switches itself off. In this case you can remove the battery, depress the button and you should see all five bulbs illuminated. Always fully charge the battery.

Replace the battery in the battery box by depressing the locking yellow button and releasing when fully engaged in the battery docking unit. You should hear/feel a satisfying click. Note the yellow button is always on the left-hand side as you view the battery box from the rear. Tug gently on the handle and the battery should remain locked in position. Close the flap.

## Li-Ion (Lithium-ion) Battery Charging

Leave the battery in chair and make sure the joystick power switch is off. Under the battery box, unhinge the small grey flap of the battery itself.

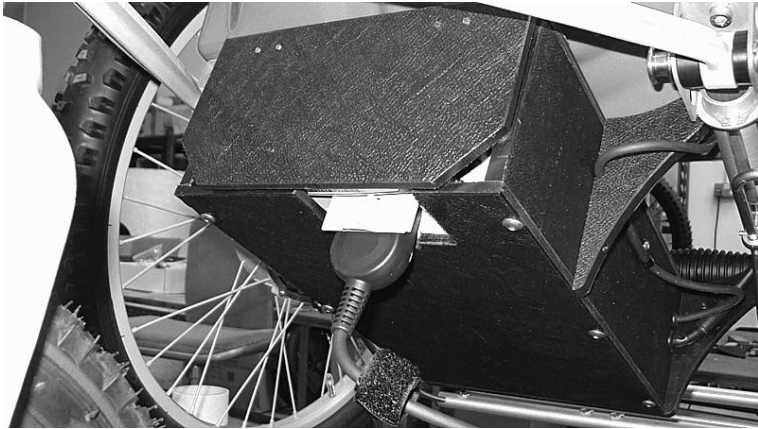

Carefully insert the charging unit connector charger (look at the shape) and then simply connect the charger. Charging takes 2-4 hours and you can see the progress, by virtue of which lamp is flashing.

As the battery charges the lamps flash and illuminated in succession and when fully charged the unit switches itself off. In this case you can remove the charger connector. To check charging you can depress the button and you should see all five bulbs illuminated.

**Always full charge the battery fully and until the charger shuts itself down.**

If you wish to remove the Li-Ion battery, ensure all power is off, turn the battery handle 90 degrees (horizontal) and withdraw the battery. To replace, lift the flap and position the battery inside the battery box. You may have to slightly flex the battery box housing downwards to clear the small lug on battery. Make sure the handle is horizontal when inserting the battery becomes fully engaged in the battery docking unit (click sound) allow the handle to drop down. The battery should remain locked in position. Close the flap.

## 6. Helpful Tips

### Kerbs

Always seek out a ramped kerb if at all possible – it's simply smoother, safer and easier on your GTE and you.

If this is not possible, there are two ways in which to get up a kerb, namely forwards or backwards. The size of kerb one can easily negotiate depends on many factors.

When the chair is fully reclined, the footrest is at its highest and small kerbs can be taken in a forward's direction. Larger kerbs represent a bit more of a challenge but with some practice, they can be taken by reversing.

Leaning forwards (if possible) allows the chair to tip forward onto the front anti tip rollers and at the same time, raises the rear castor off the ground. It is then possible to reverse the chair onto the kerb, but you will need some speed to do this, so only do so if you feel confident.

Always ensure that the castor is aligned in the forwards position when negotiating kerbs. Kerbs need to be negotiated in one movement, not by rolling backwards and forwards. To move off a kerb (up to 50mm) lean back, with the shock absorber retracted and proceed **slowly forwards** off the kerb.

### Side Plates

When you are seated in the chair fit the side plates by pushing the two pins into the two sockets on either side of the chair, textured side facing outside the chair. The pins have deliberately been designed to bend if excess pressure is applied, to prevent damage to the seat itself. Be sure to remove them before you get into the chair though as accidentally sitting on the edge could still damage the carbon fibre seating system which would not be covered by warranty. Similarly, please do not apply any pressure to the side plates when getting out of the chair as they have not been designed to support user weight. Please note that the side plates are designed to stop your clothes getting dirty or trapped – not to hold your legs in position. If you need to hold your legs, use either a strap and/or extra padding.

## Seat Liner & Pressure Cushions

The suede seat lining is attached by Velcro for easy removal. Clean only with a damp cloth and do not immerse in water. Whilst the GTE can be used without any additional cushioning the liner is not designed to prevent pressure sores. If you are concerned about pressure sores, please show the wheelchair to your Occupational Therapist before use. If you already possess a suitable pressure relieving cushion that is soft on both upper and lower surfaces, this can be used in the interim. Trekinetic also offer several different cushions so please speak to your local dealer or contact us directly if you feel you need further support in your GTE.

## Rear Wheel Punctures

If you encounter a puncture in the rear castor, the most effective solution is to change the wheel entirely and not attempt a repair in the field. If you have purchased a spare rear wheel, it will be attached to either the upper or lower side of the battery box depending on configuration. The optional Safari kit contains all the required equipment for dealing with either rear or front wheel punctures, including the relevant 10mm spanner or Allen key to remove the rear wheel.

For the rear wheel, use the hexagonal key set and undo the bolt holding the rear wheel on. Note the positions of the two washers, between the wheel bearings and the castor fork. For a reminder see sections 2-7 of [Assembly](#) which describes this process in more detail. Fit the new wheel, checking it spins freely. Inflate the tyre to 45-50 psi (or firm to touch) with the mini pump, also in the Safari kit (pic below).



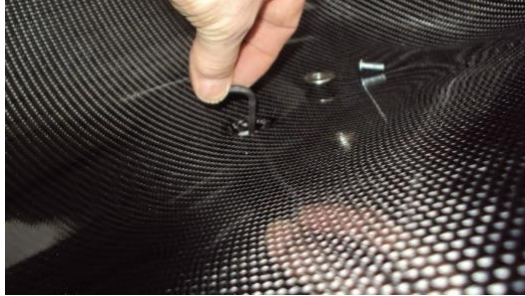

On some 19" models (only) you will need to remove the sealing plug and access the spare wheel retaining screw from above.

## Front Wheel Punctures

Before leaving home, acquaint yourself with how to change an inner tube. The Safari kit contains 3 tyre levers and a new inner tube for one front wheel. Ensure all air is out of the punctured inner tube and use the plastic tyre levers to move the tyre bead over the wheel rim, to enable you to remove the inner tube. Before re-assembly, try and locate what caused the puncture and remove it. Carefully install the new inner tube and refit the tyre bead.

Make sure you do not get the inner tube twisted or pinched between the tyre and the rim. Inflate it to 50 psi or feel it and match to the other side. In extremely hot conditions, you may experience the tyres 'popping' off the rims. In this case the heat is probably causing an increase in tyre pressure. Bleed out a little air (depress valve for one to two seconds) refit and see if things improve. For long distance expeditions, contact Trekinetic as we can advise further.

## Cleaning

On no account use a pressure washer on your GTE. The motors, battery box and joystick contain expensive electrical circuits that, though showerproof for short periods, will fail if exposed to water under pressure.

If you need to wash the wheelchair, ensure as best you can, you do not get any of these items wet, rinsing with a fine hose spray. Never have the power on when cleaning the chair. If you suspect that some water may have entered the battery



box, leave the chair for 24 hours in a warm place to dry off before switching on the power.

### **Important note**

Water damage to the circuits is not covered by warranty. Use only mild household cleansers and do not use spirit or solvents that could attack the Carbon Fibre. Use only a damp cloth for cleaning the upholstery and remove it for drying. The same applies to the chair, should it get wet. Perform these operations on a non-slip surface and apply the brakes

### **Air Travel**

The Trekinetic GTE was designed to travel but we strongly recommend you follow the below guidelines before travelling by air to ensure your GTE is handled appropriately.

You must tell the airline on booking (not upon arrival at the airport) that you will be bringing an electrically powered wheelchair. If you have the Li-ion battery option, you must inform the airline on booking as some airlines (not all) have specific conditions for the carriage of Li-Ion powered devices and you must comply with these. We recommend you get written confirmation that you have advised the airline, prior to travel. They may ask you for the UN number or other battery data and this is shown below.

At the time of writing no such conditions are imposed for the standard Nickel Metal Hydride (NMH) battery, but it may well be worth advising them in advance. If you experience problems on booking, please contact Trekinetic customer service for the latest advice.

Trekinetic strongly recommend that you request to stay in your GTE until just before you board and **do not allow** the airport staff to remove the wheels or fold the chair, prior to it being placed in the airline hold. Ensure that the airline operator's staff understand how the clutch levers and freewheel mode are applied. You may cover the seat with bubble wrap or similar for extra protection, if desired. Fully reclining the chair by closing the shock absorber is also recommended to avoid damage.

We also highly recommend that you remove the joystick by loosening the 2 x M6 screws with the appropriately sized Allen key and disconnecting the joystick

cable below the armrest. The M6 screws should then be re-tightened with the joystick removed to secure the clamping mechanism.



We also strongly recommend that you disconnect the electrical connectors on each front wheel and tie/attach them to the inner motor hubs using the holes around the periphery. If you use cable ties, use the reusable type so you can undo them without need for a sharp object. Ensure that the ends of the connectors face downwards so they cannot fill with rain. In this case note that the chair will be manually operable only and without any progressive braking. (Flipping the clutch levers to POWER will keep the chair stationary).

### **Caution**

If removing the joystick, first disconnect/pull off connector under the armrest, then power up the joystick for a moment to ensure there is no current in the joystick that may cause mild electric shock. Then switch off power and the controller screws and lower ball joint fittings may then be removed and safely stored.

The joystick controller is an expensive item and easily damaged by the careless. Ask the airline if you can carry it in your hand luggage. Naturally, removing the joystick also removes the possibility of third parties using your personal chair under power.

Our users have proven, that the method above, is the one mostly likely to ensure that your Trekinetic arrives at your destination, safely and undamaged.

### **Disclaimer**

This information is supplied in good faith, but it should not be assumed that by following it, a guarantee of safe transit will be guaranteed. Several factors are beyond our control or may need varying and responsibility for securing of the chair in transit must rest with the transport organisation, or its representatives thereof.

### **Airline and Carrier information**

Please print this page off and hand in to the airline stating whether NMH or Li-ion battery

### **Transit securing information for the aircraft hold (see diagram below)**

- 1) Do not attempt to remove wheels.
- 2) Ensure wheels are connected and in the LEAN (vertical) position with the seat upright
- 2) Ensure battery is securely docked in its box unless removed.
- 3) Disconnect the joystick cable connector, under the armrest. Note white markings
- 4) Power up the joystick for 3 seconds, then shut down, to prevent electric shock.
- 5) Release brakes (clutch levers up, both sides)
- 6) Secure with rope or similar and bungee cord, to secure floor mounts as sheet 2
- 7) Ensure ropes are taut but not tensioned.

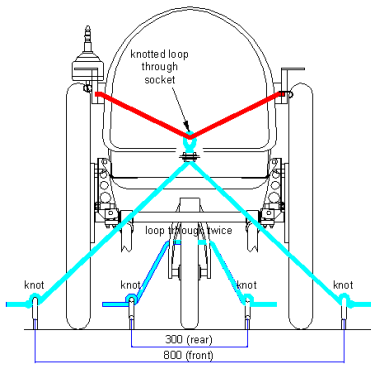

**TREKINETIC GTE**  
 WEIGHT <40 KG INCL BATTERY  
 N.B. CHAIR MUST BE OCCUPANT FREE  
 ROPES MUST BE SECURE **BUT NOT TENSIONED**  
 THIS IS NOT A GUARANTEE OF SAFE PASSAGE  
 CARRIERS MUST SATISFY THEMSELVES THAT  
 THE CHAIR IS ADEQUATELY SECURED

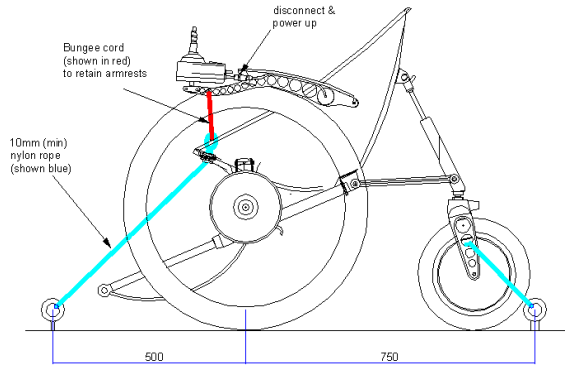

**Warning:** Mechanically tensioning the ropes/straps will likely result in extensive damage.

**Weight of chair (unoccupied) with handlebars:**

**Standard (16") GTE with Nickel Metal Hydride battery 35kg**

**Standard (16") GTE with Li-ion battery 36kg**

**Wide (19") GTE with Nickel Metal Hydride battery 37kg**

**Wide (19") GTE with Li-ion battery 38kg**

<p><b>Nickel Metal Hydride Battery</b></p> <p>Weight 4kg</p> <p>Voltage: 24v</p> <p>Amp/hour rating: 6.7 ah</p> <p>Watt/hour rating: 160 wh</p> <p><b>UN Number UN 3496</b></p>
---

<p><b>Li-ion Battery</b></p> <p>Weight 4kg</p> <p>Voltage:25v</p> <p>Amp/hour rating: 11.8 ah</p> <p>Watt/hour rating: 295 wh</p> <p><b>UN Number UN 3480</b></p>
---

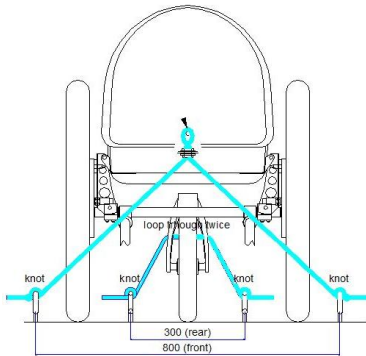

**TREKINETIC GTE**  
 WEIGHT <40 KG INCL. BATTERY  
 N.B. CHAIR MUST BE OCCUPANT FREE  
 ROPES MUST BE SECURE **BUT NOT TENSIONED**  
 THIS IS NOT A GUARANTEE OF SAFE PASSAGE  
 CARRIERS MUST SATISFY THEMSELVES THAT  
 THE CHAIR IS ADEQUATELY SECURED

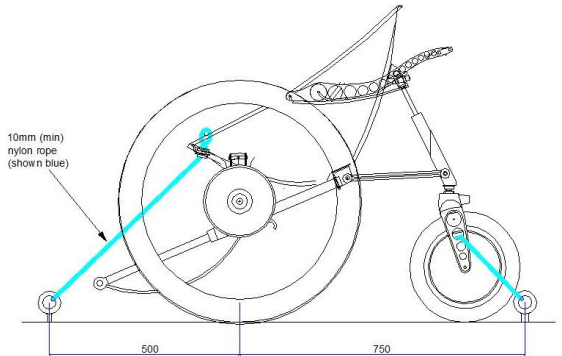

*Securing method when Joystick has been removed*

## Other Technical Data

### Maximum dimensions

Maximum Width (19" model): Approximately 81cm

Maximum Length: Approximately 120 cm

Maximum Height: Approximately 84/100cm (with/without handlebars, excluding extensions)

### Dimensions folded.

Body (19" model): with wheels removed: Approximately 840 x 430 X 520 mm

Wheels: Approximately 640 diameter X 160mm thick each

Weights: Approximately 34-40 kg dependant on specification

Tyre pressures - 45 - 50 PSI all round.

Max user weight - up to 115kg/250lbs/18 stone





All attachment screws are metric.

Use utmost care not to round the sockets, if tightening is deemed necessary.

## Immobiliser activation and deactivation

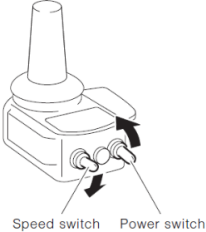

By setting the anti-tampering function, you can prevent operation of the wheelchair using the controller.

### (1) Setting Method

Purpose of Operation	Operation Method	Parameter Status during Operation and Its Meaning
<p>[Preparation]</p> <p>[1] Prepare to set the anti-tampering function.</p>	<p>Stop the wheelchair in a stable state, engage the parking brake, and power OFF.</p>	 <p style="text-align: center;"><u>Off</u></p>
<p>[2] [Start Operation]</p>	 <p style="text-align: center;">Speed switch    Power switch</p> <ol style="list-style-type: none"> <li>① Turn on the power switch.</li> <li>② Lower the speed switch to select the slowest speed, and then release your hand from the switch.</li> </ol>	 <p style="text-align: center;">↓</p> 
<p>[3] [Anti-tampering Function Setting]</p>	 <p style="text-align: center;">Speed switch</p> <ol style="list-style-type: none"> <li>① Hold down the speed switch.</li> <li>② Once the buzzer beeps, release your hand from the switch.</li> <li>③ Immediately hold down the horn switch.*</li> <li>④ Confirm that the anti-tampering function setting is complete on the LCD.</li> </ol>	 <p style="text-align: center;"><u>Anti-tampering function setting screen</u></p>

\* If the buzzer sounds when the horn switch is pushed, the operation was not completed successfully. Hold down the speed switch again and repeat the procedure.

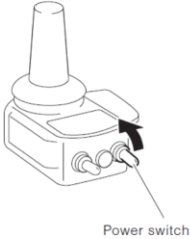
## (2) Canceling Method

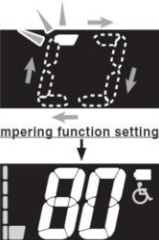
Purpose of Operation	Operation Method	Parameter Status during Operation and Its Meaning
<p><b>[Preparation]</b></p> <p>[1] Prepare to cancel the setting for the anti-tampering function.</p>	<p>Stop the wheelchair in a stable state, engage the parking brake, and power OFF.</p>	 <p><b>Off</b></p>
<p>[2] <b>[Start Operation]</b></p>	 <p>Power switch</p> <p>① When the power switch is turned on, the screen shown to the right is displayed.</p>	
<p>[3] <b>[Canceling the Anti-tampering Function Setting]</b></p>	 <p>Speed switch</p> <ol style="list-style-type: none"> <li>① Hold the speed switch up.</li> <li>② Once the buzzer beeps, release your hand from the switch.</li> <li>③ Immediately hold down the horn switch.*</li> <li>④ Confirm that the cancellation of the anti-tampering function setting is complete on the LCD.</li> </ol>	 <p>Anti-tampering function setting screen</p> <p>Normal screen</p>

\* If the buzzer sounds when the horn switch is pushed, the operation was not completed successfully. Hold down the speed switch again and repeat the procedure.

## 7. Maintenance

Your Trekinetic GTE needs to be regularly maintained to stay in good working order. Below is a short guide with some tips on how to maintain your GTE.

### General

Trekinetic recommend that you check the tyre pressures seat reclining operation at weekly intervals.

Check all nuts and bolts for tightness every 2 weeks and use only metric hexagonal keys in good condition. Ensure that keys are inserted fully and do not over tighten. See [Torque Settings](#) for more detail. Any locking nylon insert nuts must be replaced with new, if removed. If you are not sure, please contact your dealer or contact us directly if you don't have a local dealer.

## Tyre Pressures

Tyre pressures can be found on the sidewall of the tyre but where there is a range, our recommendations are as below.

Mountain Bike/Smooth Tyres - 50 psi

Whitewall/Blackwall Beach Tyres - 36-40psi

## Footrest

In the event of tightness of the sliding footrest or cross shaft threads an amount of **Nylon** or **WD40** type **lubricant** may be applied to the threads and into the slots in the tubes immediately under the monocoque seat.

## Rear Castor

The rear wheel castor fork has an M16 grub screw that is used to vary the detent pressure on the rear wheel, which varies how much effort is required to turn the rear castor. This typically doesn't need adjustment, but it may warrant tightening or loosening slightly if the user is particularly heavy or light respectively.





To re-grease, undo the grub screw completely, fill the cavity with general purpose automotive grease and refit the screw, whilst periodically rotating the castor. Repeat until grease is seen appearing from the top bearing. Wipe clean. Re-greasing is only normally required at service as stated below.

## Servicing

Dependant on the frequency and type of use, we recommend taking your wheelchair to an authorised dealer for service at a minimum of every 6-12 months.

## Beach Use

Sand and sea water air can easily damage the moving parts of your wheelchair. Clean the wheelchair thoroughly after exposure, if you ever use your chair on sand or in abrasive environments.

Do not try and dismantle the wheelchair yourself, beyond the guidelines in the above sections. The method of assembly is not necessarily obvious, and breakage or failure may occur with incorrect disassembly or reassembly. Many of the screws also have small hexagonal sockets that can be easily rounded off.

## Nameplate

Details of your specific GTE including chassis number, etc. are located on the underside of the seat and behind the user's right side and removable cushion.

The nameplate indicates the exact model designation and other specifications. Please provide the following whenever you have to arrange service, order replacement parts or discuss your wheelchair.

Model - GTE

Chassis Number -

GMDN number -

Year of manufacture -

## Torque Settings

When tightening screws please be sure to use the below torque settings. If you are unsure how to do this, please consult your local Trekinetic dealer or Service Centre.

M4 screws 2.6 Nm

M5 screws 5.1 Nm

M6 screws 8.3Nm

## 8. Troubleshooting

The Trekinetic GTE is an advanced machine, with tightly integrated mechanical and electrical components. It is crucial that it is maintained in line with the

guidance in this manual and serviced regularly to ensure good working order. The below list however provides some suggestions to some known issues in all cases, please switch off power before performing checks.

### **1. Joystick beeping continuously on powering up**

- Check electrical connectors (including joystick connector under armrest) are correctly engaged.
- Check clutch levers are in the 'POWER' mode position.
- Check battery is properly engaged in docking unit.

### **2. Joystick Fault Code displayed**

- Check all connections are in order as per point 1.
- Refer to [Appendix I](#) for further detail on fault codes.

### **3. Wheelchair tips forwards when joystick is released**

- Gently release the joystick to bring the chair to a smooth stop.
- If on smooth level ground, reclining the seat to the maximum position will also reduce the effect.

### **4. Wheelchair feels 'wobbly' or pulling to one side**

#### **Possible Solutions**

- Cross shaft not fully tightened (rotated) in direction of either 'MEAN' or 'LEAN.
- There is no acceptable mid position between the two extremes so it must be fully set at one position.
- Incorrect tyre pressures – re-pressurise to 50 psi all round
- Wheels and quick release axles not pushed fully in. Refit correctly –check if marked regarding which side. Right is always users right, when seated.
- Rear strut bracket not full engaged – refit correctly.
- Rear castor loose – see dealer
- Screws loose – check and tighten

## 5. Wheelchair not running straight

- Tyre pressures uneven – re-pressurise to 45-50 psi all round
- Rear castor nut loose and castor misaligned - Tighten nut if possible then seek dealer assistance. A loose castor will eventually become detached, so do not continue without attending to the problem.

## 6. Wheelchair difficult to turn

- Check rear castor is rotating correctly. It should rotate freely, but a slight increase in pressure at the straight-ahead position, should be felt. Apply general purpose grease through grease point if required or see dealer.

## 7. Tyres rubbing or too close to seat

- Cross shaft not fully tightened – tighten
- Carriers need adjustment – see dealer
- In an emergency, rotate the crossbar towards 'LEAN' to bring the wheels back into an upright position. Seek dealer advice as soon as possible.



## 8. Footrest difficult to slide







- Lubrication required . Apply a spot of nylon lubricant (or WD40) to the telescopic tubes and inside the slots in the tubes immediately under the underside of the seat. Do not use general grease **in this area**, as it may dissolve the plastic parts.
- Sand, grit or dirt ingress – Clean out if possible or see dealer





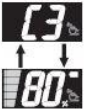



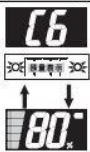

## 9. Electromagnetic brakes ineffective.



- Contact your dealer immediately

# 9. Appendix 1: Advanced Trouble Shooting

ON  OFF  Blinking  Controller display  Assistant controller display 

Warning Display (▲ blinking)	Buzzer	Item	Details	Unit Operation	Recovery
	Beeps 4 times (2 short beeps each time)	Clutch disengagement	One or both clutches become disengaged while driving.	Does not move.	When the clutch engages at the gear side.
			Improper clutch adjustment (clutch cable too tight)	Moves a little, then stops.	Properly adjust the clutch cable.
			Improper clutch switch adjustment	Moves a little, then stops.	Properly adjust the clutch switch.
	Beeps for 2.5 seconds	Dash out prevention	The user has moved the control lever before turning on the power.	Does not move.	Turn on the power without moving the control lever.
			With the speed switch raised (or lowered), the user has turned on the power.	Does not move.	Turn on the power without touching the speed switch.
	Beeps repeatedly (short beep and long beep)	Retracted anti-tip device (wheelchair can move)	The anti-tip device is retracted.	Able to continue moving.	Extend the anti-tip device.
	No	Power warning (power is already turned on)	With the power already turned on, the power switch for the controller or assistant controller was turned on.	Device with power turned on first: Able to continue moving. Device with power turned on later: Cannot move.	Turn off the power for the device that was turned on later.
	Beeps repeatedly (continuous short beeps)	Torque limit 1	The temperature of the motor or motor controller circuit board has exceeded the specified value.	Limits the current to the motor to one-half of the maximum amperage.	Turn on the power again after the temperature decreases.
	One-second beeping (long beep) repeatedly	Heavy loading alert	Excessive load is applied on the motor.	Able to continue moving.	Reduce the load on the motor.

Warning Display (▲ blinking)	Buzzer	Item	Details	Unit Operation	Recovery
	Beeps repeatedly (continuous short beeps)	Torque limit 2	The wheelchair is stuck against an object for more than 16 seconds, but less than 24 seconds.	Limits the current to the motor to one-half of the maximum amperage.	Free the wheelchair from being stuck or return the control lever.
	Beeps for 2.5 seconds	Overload protection 1	The temperature of the motor or motor controller circuit board has exceeded "specified value 2".	Stops slowly.	Turn on the power again, and then the temperature decreases.
	Beeps for 2.5 seconds	Overload protection 2	The wheelchair is stuck against an object for more than 24 seconds.	Stops slowly.	Return the joystick lever (this can be repeated up to 5 times).
	Beeps for 2.5 seconds	Overload protection 2	The wheelchair has repeatedly struck an object for 6 times or more.	Stops slowly.	Turn on the power again and return the control lever.
	Beeps 5 times (0.5-second beeps)	10 seconds before battery cutoff	There are 10 seconds remaining before the battery power is cut off.	Stops moving after 10 seconds.	Charge the battery, and then turn on the power again.
	Beeps repeatedly (continuous short beeps)	Battery current limit	The battery temperature is outside its normal range (1: below -5°C, 2: below -10°C, 3: above 60°C). Or, the BMC temperature has exceeded its normal range (4: above 100°C).	1: Limits the battery amperage to be below 16 A. 2: Limits the battery amperage to be below 8 A. 3: Limits the battery amperage to be below 10 A. 4: Limits the battery amperage to be below 10 A.	Return the temperature to within the normal range.
	Beeps 4 times (4 short beeps each time)	Battery residual capacity warning (communication normal)	Battery residual capacity is below 5 to 10%.	Able to continue moving.	Charge the battery, and then turn on the power.
	Beeps 5 times; then, 5 seconds later, beeps for 2.5 seconds	Battery level alert (communication normal)	Battery residual capacity is 0.	Stops slowly.	Charge the battery, and then turn on the power.
	Beeps 4 times (4 short beeps each time)	Battery residual capacity warning (no communication)	With the communication between the battery and the wheelchair disrupted, the battery voltage has dropped below "specified value 2".	Able to continue moving.	Charge the battery, and then turn on the power again. Then, the signal will come from the BMC.
	Beeps 5 times; then, 5 seconds later, beeps for 2.5 seconds	Battery level alert (no BMC communication)	With the communication between the battery and the wheelchair disrupted, the battery voltage has dropped below "specified value 1".	Stops slowly.	Charge the battery, and then turn on the power again. Then, the signal will come from the BMC.
	No	No BMC communication	No signals are coming from the battery (BMC).	Able to continue moving.	The signals start coming from the BMC.

Warning Display (▲ blinking)	Buzzer	Item	Details	Unit Operation	Recovery
	Beeps for 2.5 seconds	JW Smart Tune cable insertion (when set to stop)	The JW Smart Tune cable is inserted.	Does not move.	Disconnect the JW Smart Tune cable.
	No	JW Smart Tune cable insertion (when set to notification only)	The JW Smart Tune cable is inserted.	Able to continue moving. (During reading, writing, and other communication, cannot move.)	Disconnect the JW Smart Tune cable.

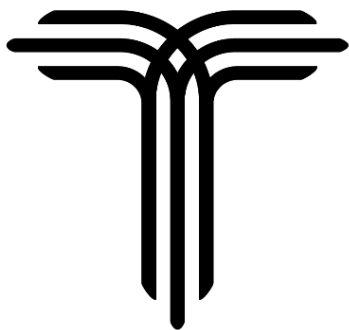

TREKINETIC

[www.trekinetic.com](http://www.trekinetic.com)

+44(0)1442 252 700

[info@trekinetic.com](mailto:info@trekinetic.com)